

## 1. Unpack your Aptiva® PC

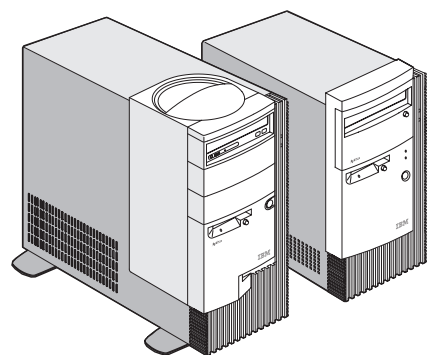

Locate the following items:



System unit  
(minitower or microtower)



Modem cord



Power cord

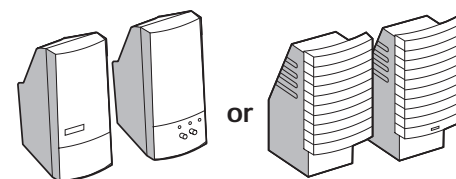

Speakers  
(powered or unpowered)



Publications and CD-ROMs



Mouse



Speaker power adapter  
(provided with powered speakers only)



Keyboard

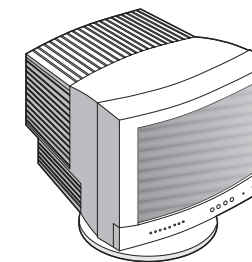

Monitor with stand you attached  
(may be sold separately)

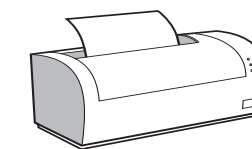

Printer (sold separately)

## 2. Connect the system components

Attach components to the computer as shown.  
If you need setup instructions for components that are not shown here, refer to the back of this sheet or the instructions that came with the component.

**Note:** Most cable connectors are color-coded to match the location at the back of the system unit where you connect the cable.

Read "Safety information" in the *Aptiva Reference Guide* to learn about connecting cables.

For machine type 2170, incorrectly installing speakers other than those originally shipped with your Aptiva PC could cause permanent damage to your speakers. Look in Aptiva Help for information about installing amplified speakers.

The back of your speaker looks like one of the two speakers shown in this picture.

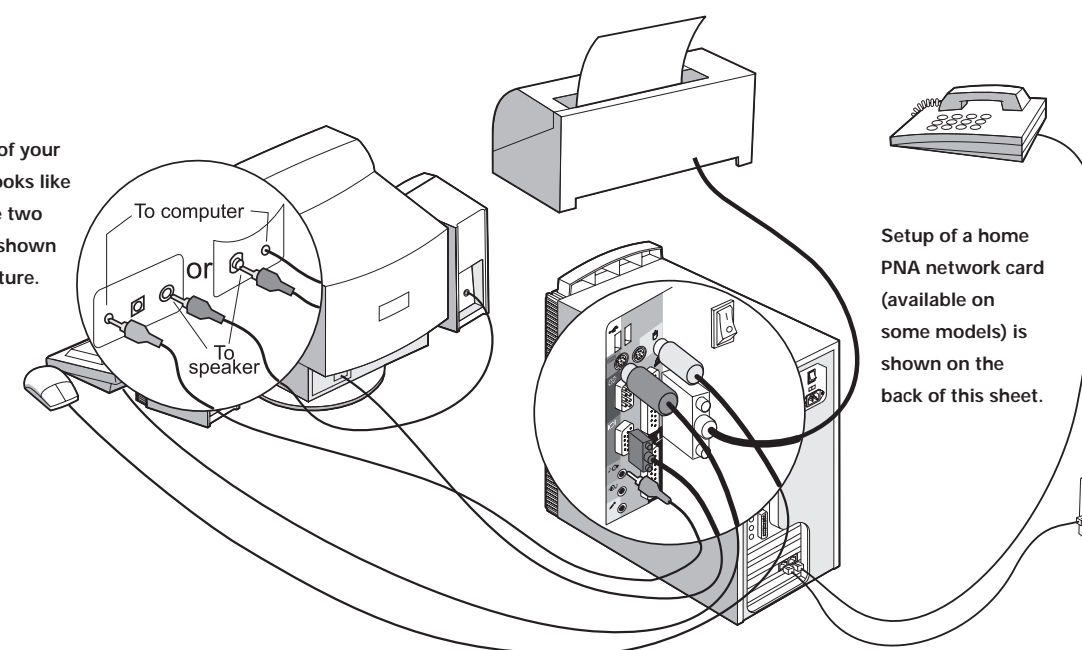

Setup of a home PNA network card (available on some models) is shown on the back of this sheet.

## 3. Connect Power cords

The voltage selector switch should be preset for your area; however, contact your local power company if you are uncertain of the voltage for your area.

- If the voltage supply range in your area is 100-127V, set the voltage selector switch so you can see 115V or 115.
- If the voltage supply range in your area is 200-240V, set the voltage selector switch so you can see 230V or 230.

Connect the power cords to the computer and monitor first, and then connect the power cords to the electrical outlets. For clarity, only the power cords are shown in this picture.

**Note:** If your computer has a power switch on the back of the computer, press it in the ON position (1=ON).

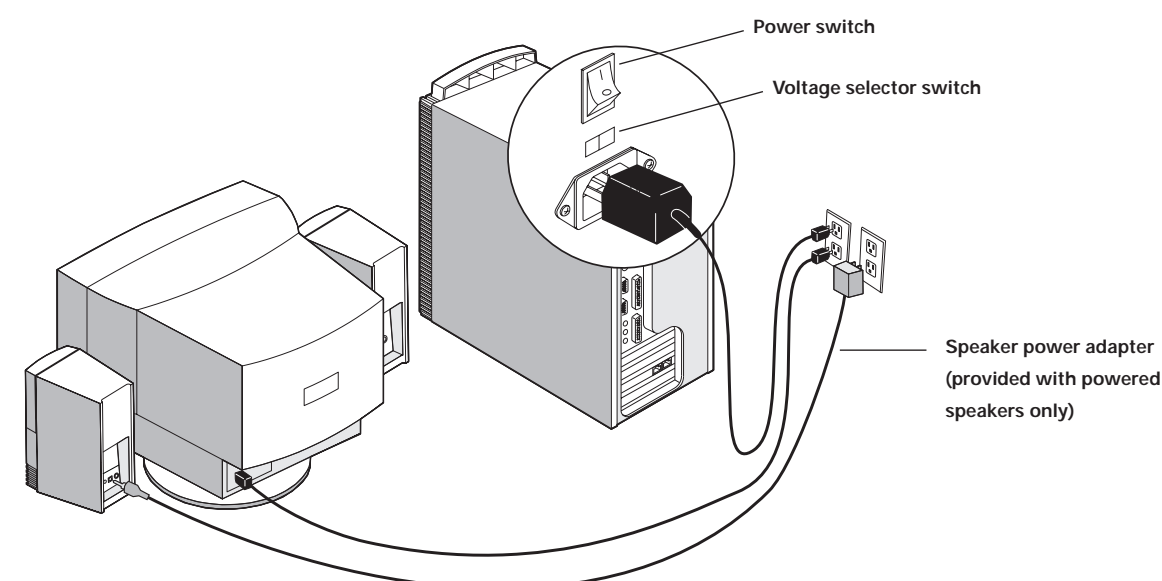

Speaker power adapter  
(provided with powered speakers only)

(Continued on back)

## 4. What to do next

- A. Turn on the monitor and the computer (and powered speakers, if provided).

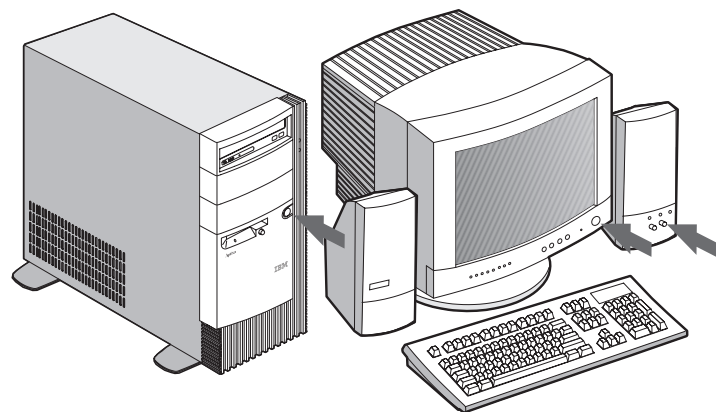

- B. You must complete the Windows 98 setup. During this process, you must type the Windows Product ID number printed on the *Certificate of Authenticity* that came with the *Introducing Microsoft Windows 98* booklet.



- C. When the Windows 98 setup is completed, the Windows 98 Desktop appears.

**Important:** Please read the license agreements carefully before using the programs included with this system. These agreements detail your rights, obligations, and warranties for the software included with this system. By using the programs, you agree to the terms of these agreements. If you do not accept the agreements included with this system, do not use the programs. Instead, promptly return the system for a full refund. To read the license, click **View license and warranty** and then click **View the license**.

Insert the *Software Selections CD-ROM* into your CD-ROM drive. (If you need instructions for operating your CD-ROM drive, refer to the *Aptiva Reference Guide*.) The CD will automatically install several important programs. Then, the *Software Selections* program will start and you will have the opportunity to install additional programs.

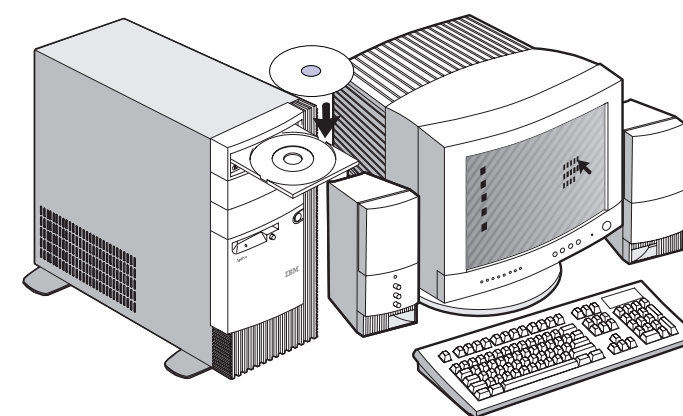

When you have finished installing the programs, click on **How do I** and **Get Help** in *Access Aptiva* to learn about your computer.

If computer problem occurs, refer to the "Troubleshooting" and "Aptiva Help and Software" chapters in the *Aptiva Reference Guide*. Save this setup sheet for future reference.

## 5. Connecting additional components

The following figures show you how to connect additional components that might have come with your computer (or that you purchased separately). Some components may require software or BIOS setup. Turn the computer off before connecting non-Plug and Play components. Refer to the documentation that came with the component for more information.

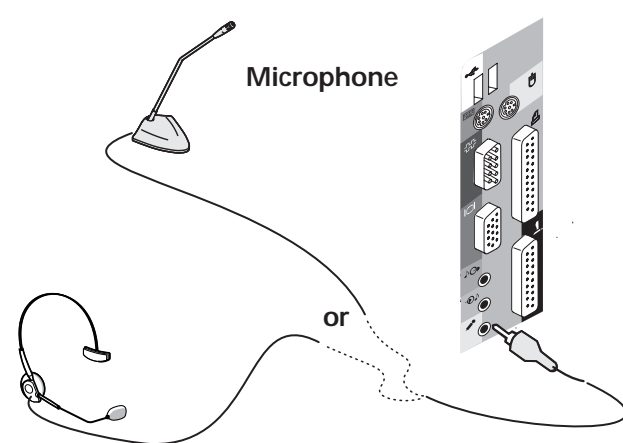

Headset microphone (without speaker)

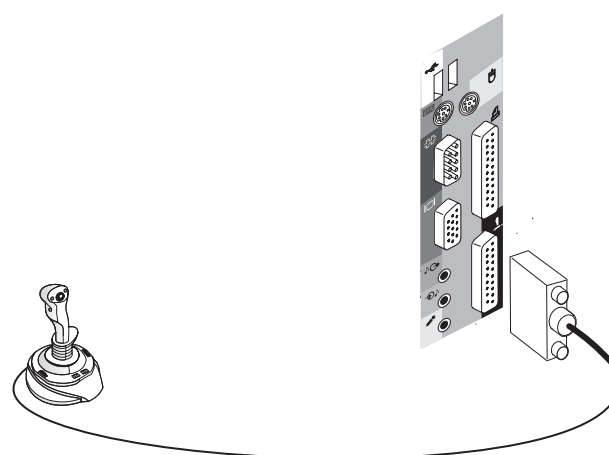

Joystick

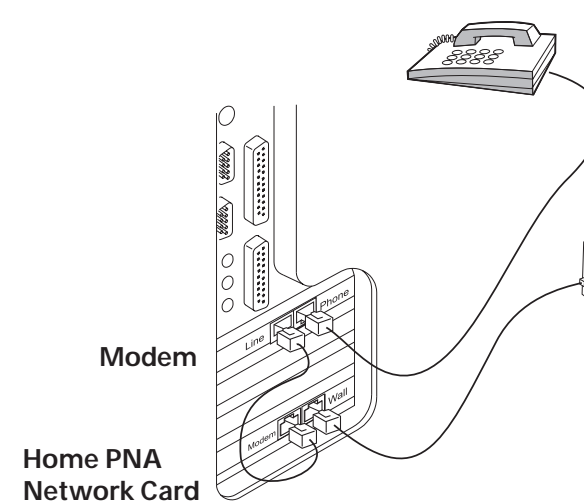

You must connect each computer on the PNA home network directly to a telephone-line wall connector. If you have more computers than telephone-line wall connectors in a room, use a telephone splitter at the wall connector.

For models with a home PNA network card, you must install the Intel® AnyPoint™ software from the *Software Selections CD-ROM* after you set up your computer. Each computer on the home PNA network must have a home PNA network card and the associated software installed.

