

Canon

PUB. DIE-0448-000A

HD Camcorder  
Instruction Manual

VIXIA  
HF R50

VIXIA  
HF R52

VIXIA  
HF R500



NTSC



HDMI

AVCHD  
Progressive

MP4

HF R52/R50

# Important Usage Instructions

**WARNING**

TO REDUCE THE RISK OF FIRE OR ELECTRIC SHOCK, DO NOT EXPOSE THIS PRODUCT TO RAIN OR MOISTURE.

**COPYRIGHT WARNING:**

Unauthorized recording of copyrighted materials may infringe on the rights of copyright owners and be contrary to copyright laws.

The Mains plug is used as the disconnect device. The Mains plug shall remain readily operable to disconnect the plug in case of an accident.

While using the compact power adapter, do not wrap it or cover it with a piece of cloth, and do not place it in confined narrow spaces.

**CAUTION:**

**TO REDUCE THE RISK OF ELECTRIC SHOCK, DO NOT REMOVE COVER (OR BACK). NO USER-SERVICEABLE PARTS INSIDE. REFER SERVICING TO QUALIFIED SERVICE PERSONNEL.**



The lightning flash with arrowhead symbol, within an equilateral triangle, is intended to alert the user to the presence of uninsulated "dangerous voltage" within the product's enclosure, that may be of sufficient magnitude to constitute a risk of electric shock to persons.



The exclamation point, within an equilateral triangle, is intended to alert the user to the presence of important operating and maintenance (servicing) instructions in the literature accompanying the product.

## FCC/IC NOTICE

### HD Camcorder, ID0019 / ID0022 systems

This device complies with Part 15 of the FCC Rules. Operation is subject to the following two conditions: (1) This device may not cause harmful interference, and (2) this device must accept any interference received, including interference that may cause undesired operation.

Note: This equipment has been tested and found to comply with the limits for class B digital device, pursuant to Part 15 of the FCC Rules. These limits are designed to provide reasonable protection against harmful interference in a residential installation. This equipment generates, uses and can radiate radio frequency energy and, if not installed and use in accordance with the instructions, may cause harmful interference to radio communications. However, there is no guarantee that interference will not occur in a particular installation. If this equipment does cause harmful interference to radio or television reception, which can be determined by turning the equipment off and on, the user is encouraged to try to correct the interference by one or more of the following measures:

- Reorient or relocate the receiving antenna.
- Increase the separation between the equipment and receiver.
- Connect the equipment into an outlet on a circuit different from that to which the receiver is connected.
- Consult the dealer or an experienced radio/TV technician for help.

Use of shielded cable is required to comply with class B limits in Subpart B of Part 15 of FCC Rules. Do not make any changes or modifications to the equipment unless otherwise specified in the manual. If such changes or modifications should be made, you could be required to stop operation of the equipment.

### Model ID0019 (including WLAN Module Model WM217, FCC ID: AZD217)

This device complies with Industry Canada license-exempt RSS standard(s). Operation is subject to the following two conditions: (1) this device may not cause interference, and (2) this device must accept any interference, including interference that may cause undesired operation of the device.

This transmitter must not be co-located or operated in conjunction with any other antenna or transmitter.

The available scientific evidence does not show that any health problems are associated with using low-power wireless devices. There is no proof, however, that these low power wireless devices are absolutely safe. Low-power wireless devices emit low levels of radio frequency energy (RF) in the microwave range while being used. Whereas high levels of RF can produce health effects (by heating tissue), exposure to low-level RF that does not produce heating effects causes no known adverse health effects. Many studies of low-level RF exposures have not found any biological effects. Some studies have suggested that some biological effects might occur, but such findings have not been confirmed by additional research. This model has been tested and found to comply with FCC/IC radiation exposure limits set forth for an uncontrolled equipment and meets the FCC radio frequency (RF) Exposure Guidelines in Supplement C to OET65 and RSS-102 of the IC radio frequency (RF) Exposure rules.

Canon U.S.A., Inc.  
One Canon Park, Melville, NY 11747, USA  
Tel No. 1-800-OK-CANON (1-800-652-2666)

CAN ICES-3(B)/NMB-3(B)

# IMPORTANT SAFETY INSTRUCTIONS

In these safety instructions the word “apparatus” refers to the Canon HD Camcorder VIXIA HF R52 / VIXIA HF R50 / VIXIA HF R500 and all its accessories.

- 1 Read these instructions.
- 2 Keep these instructions.
- 3 Heed all warnings.
- 4 Follow all instructions.
- 5 Do not use this apparatus near water.
- 6 Clean only with dry cloth.
- 7 Do not install near any heat sources such as radiators, heat registers, stoves, or other apparatus (including amplifiers) that produce heat.
- 8 Protect the power cord from being walked on or pinched particularly at plugs, convenience receptacles, and the point where they exit from the apparatus.
- 9 Only use attachments/accessories specified by the manufacturer.
- 10 Unplug this apparatus during lightning storms or when unused for long periods of time.
- 11 Refer all servicing to qualified service personnel. Servicing is required when the apparatus has been damaged in any way, such as power-supply cord or plug is damaged, liquid has been spilled or objects have fallen into the apparatus, the apparatus has been exposed to rain or moisture, does not operate normally, or has been dropped.

CA-110 identification plate is located on the bottom.

## REGIONS OF USE

VIXIA HF R52 and VIXIA HF R50 are in compliance (as of November 2013) with the radio signal regulations of the regions listed below. For details on other regions where they can be used, make inquiries with the contacts listed at the end of this instruction manual.

### REGIONS

Canada, Hong Kong S.A.R., South Korea, Taiwan, USA

### Model

ID0019: VIXIA HF R50 / VIXIA HF R52

## Trademark Acknowledgements

- SD, SDHC and SDXC Logos are trademarks of SD-3C, LLC.
- Microsoft and Windows are trademarks or registered trademarks of Microsoft Corporation in the United States and/or other countries.
- App Store, iPad, iPhone, iTunes and Mac OS are trademarks of Apple Inc., registered in the U.S. and other countries.
- HDMI, the HDMI logo and High-Definition Multimedia Interface are trademarks or registered trademarks of HDMI Licensing LLC in the United States and other countries.
- "AVCHD", "AVCHD Progressive" and the "AVCHD Progressive" logo are trademarks of Panasonic Corporation and Sony Corporation.
- Manufactured under license from Dolby Laboratories. "Dolby" and the double-D symbol are trademarks of Dolby Laboratories.
- Google, Android, Google Play, YouTube are trademarks of Google Inc.
- Facebook is a registered trademark of Facebook, Inc.
- IOS is a trademark or registered trademark of Cisco in the U.S. and other countries and is used under license.
- The Twitter name and marks are trademarks of Twitter, Inc.
- Wi-Fi is a registered trademark of the Wi-Fi Alliance.
- Wi-Fi Certified, WPA, WPA2, and the Wi-Fi Certified logo are trademarks of the Wi-Fi Alliance.
- WPS as used on the camcorder's settings, onscreen displays and in this manual signifies Wi-Fi Protected Setup.
- The Wi-Fi Protected Setup Identifier Mark is a mark of the Wi-Fi Alliance.
- Other names and products not mentioned above may be trademarks or registered trademarks of their respective companies.
- This device incorporates exFAT technology licensed from Microsoft.
- "Full HD 1080" refers to Canon camcorders compliant with high-definition video composed of 1,080 vertical pixels (scanning lines).
- This product is licensed under AT&T patents for the MPEG-4 standard and may be used for encoding MPEG-4 compliant video and/or decoding MPEG-4 compliant video that was encoded only (1) for a personal and non-commercial purpose or (2) by a video provider licensed under the AT&T patents to provide MPEG-4 compliant video. No license is granted or implied for any other use for MPEG-4 standard.



# Exciting Features and New Functions

---



**HFR52/R50**  
**Wi-Fi Functions**  
(📖 117)

Enjoy the freedom of Wi-Fi\* by using convenient Wi-Fi functions such as the following.

- You can use a smartphone as a remote control and record movies from a distance (📖 120).
- You can wirelessly connect the camcorder to your home network and upload your recordings to CANON IMAGE GATEWAY (📖 128). This will allow you to even share your videos on YouTube and Facebook. You can share your videos on YouTube and Facebook also directly from an iOS device (📖 126).
- Enjoying your recordings with family and friends has just become easier because you can use the Web browser on a smartphone or computer to view the camcorder's recordings (📖 125).

\* Wi-Fi is a connection method for devices to connect wirelessly and is certified by the Wi-Fi Alliance.

---

## Baby Mode (📖 60)



Using Baby mode, you will not miss out on baby's precious moments. The camcorder's settings are optimized to capture the beauty of baby's skin. You can also add stamps to the video to keep track of baby's growth. Baby mode is for AVCHD movies only.

---

## AVCHD and MP4 Recording (📖 56)

AVCHD  
Progressive



You can choose to record movies in AVCHD or MP4 format. Record movies in AVCHD and play them back with fantastic picture quality. Alternatively, record movies in MP4 for uploading to the Web and transferring to mobile devices. Depending on the video quality, you can also record at 60 frames per second. With video at 60 frames per second, your videos will achieve a level of realistic movement that will impress your audience.

---



## Smart AUTO (📖 42)

Smart AUTO automatically selects the best scene mode for the scene you want to shoot. You get spectacular recordings every time without worrying about settings.



## Video Snapshot (📖 71)

Shoot or capture short scenes and arrange them into a video clip set to your favorite background music.

## Cinema-Look Filters (📖 61)



Use professional cinema-look filters to create unique movies with distinctive looks.

---

## Face Detection (📖 72)



The camcorder automatically detects people's faces and adjusts the focus and other settings accordingly for beautiful results.

---

## Image Stabilization



Dynamic IS (📖 148) compensates for camcorder shake when you shoot video while walking. Powered IS (📖 143) will produce stable shots when you zoom in on distant subjects (full telephoto). Intelligent IS (📖 43) selects the type of image stabilization for the recording situation.

---

## Enjoying Your Recordings on Other Devices

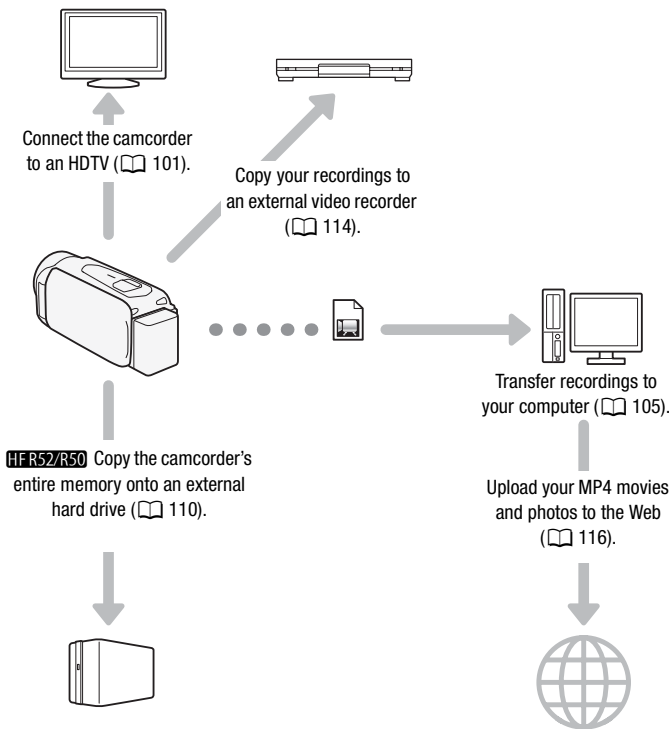



## Enjoying Your Recordings Using the Camcorder's Wi-Fi Functions



Use your iOS/Android device to remotely control the camcorder (📖 120).

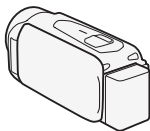

Connect the camcorder to an access point on your home network and then share your recordings on CANON iMAGE GATEWAY (📖 128). From there, you can make online albums to enjoy your recordings.



Use the Web browser on your iOS/Android device to view the recordings on the camcorder (📖 125).



Save your recordings on an iPhone or iPad and play them back (📖 126).



After connecting the camcorder to an iOS device or CANON iMAGE GATEWAY, you can upload your recordings to other Web sites.

# Table of contents

## ■ Introduction

- 6 Exciting Features and New Functions
- 14 About this Manual
- 16 Getting to Know the Camcorder**
- 16 Supplied Accessories
- 17 Names of Parts

## ■ Preparations

- 20 Getting Started**
- 20 Charging the Battery Pack
- 23 Using a Memory Card**
- 23 Memory Cards Compatible for Use with the Camcorder
- 24 Inserting and Removing a Memory Card
- 26 First Time Settings**
- 26 Basic Setup
- 28 Changing the Time Zone
- 29 Initializing the Memory
- 31 Basic Operation of the Camcorder**
- 31 Using the Touch Screen
- 32 Using the Menus
- 36 Operating Modes

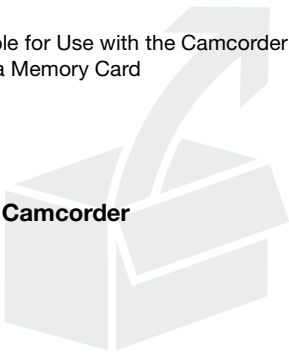

## ■ Basic Shooting and Playback

### 37 Basic Recording

- 37 Shooting Video
- 40 Taking Photos
- 41 AUTO Mode
- 43 Zooming

### 46 Basic Playback

- 46 Playing Back Video
- 50 Viewing Photos
- 53 Deleting Recordings

## ■ Advanced Shooting

- 56 Selecting the Movie Format (AVCHD/MP4)
- 56 Selecting the Video Quality
- 58 **HFR52/R50** Selecting the Memory (Built-in Memory/  
Memory Card) for Recordings
- 58 **HFR52/R50** Dual Recording and Relay Recording
- 59 Shooting Modes
- 60 Baby Mode
- 61 Cinema Mode and Cinema-Look Filters
- 62 Special Scene Modes
- 64 Programmed AE Mode: Adjusting Settings to Match Your  
Needs
- 65 Decoration: Adding a Personal Touch
- 71 Video Snapshot
- 72 Face Detection and Tracking
- 74 Faders
- 75 Adjusting the Exposure
- 76 Adjusting the Focus
- 78 White Balance
- 79 Frame Rate
- 80 Tele Macro
- 81 Audio Scenes
- 82 Using Headphones
- 83 Using an External Microphone

## ■ **Advanced Playback and Editing**

- 85 Capturing Video Snapshot Scenes and Photos from a Movie
- 87 Playback with Background Music
- 89 Selecting the Playback Starting Point
- 91 Dividing Scenes
- 92 Trimming Scenes
- 93 Changing the Thumbnail Image of a Scene
- 94 Photo Slideshow
- 95 **HFR52/R50** Copying Recordings to a Memory Card

## ■ **External Connections**

### **98 Terminals on the Camcorder**

- 99 Connection Diagrams

### **101 Playback on a TV Screen**

### **103 Saving and Sharing Your Recordings**





- 103 **HFR52/R50** Converting Movies to MP4 Format
- 105 Saving Recordings on a Computer
- 110 **HFR52/R50** Memory Save: Saving an Entire Memory onto an External Hard Drive
- 114 Copying Recordings to an External Video Recorder
- 116 Uploading MP4 Movies and Photos to the Web

## ■ **HFR52/R50 Wi-Fi Functions**

- 117 The Camcorder's Wi-Fi Functions
- 120 Using an iOS or Android Device as a Remote Control
- 125 Remote Browse: Viewing Recordings Using a Web Browser on an iOS or Android Device
- 126 Saving Recordings and Uploading Movies to the Web Using an iOS Device
- 128 Sharing Recordings with CANON iIMAGE GATEWAY
- 132 Wireless Playback on a Computer
- 133 Wi-Fi Connection Using an Access Point
- 138 Viewing and Changing Wi-Fi Settings

## ■ Additional Information

### 141 Appendix: Menu Options Lists

- 141  (Home) Menu
- 142  Recording Setup] Menu
- 142  Main Functions] and [Edit] Panels
- 146  Other Settings] Menus

### 155 Appendix: Onscreen Icons and Displays

### 159 Trouble?

- 159 Troubleshooting
- 165 List of Messages

### 175 Do's and Don'ts

- 175 Handling Precautions
- 179 Maintenance/Others
- 180 Using the Camcorder Abroad





### 181 General Information

- 181 Optional Accessories
- 184 Specifications
- 188 Reference Tables
- 192 Downloading Music Files and Image Files (Image Mix Frames)
- 194 Index

# About this Manual

Thank you for purchasing the Canon VIXIA HF R52 / VIXIA HF R50 / VIXIA HF R500. Please read this manual carefully before you use the camcorder and retain it for future reference. Should your camcorder fail to operate correctly, refer to *Troubleshooting* (📖 159).

## Conventions Used in this Manual

-  **IMPORTANT:** Precautions related to the camcorder's operation.
-  **NOTES:** Additional topics that complement the basic operating procedures.
-  **POINTS TO CHECK:** Restrictions or requirements regarding the function described.
-  Reference page number within this manual.
- **HF R52/R50:** Text that applies only to the model(s) shown in the icon.
- The following terms are used in this manual:
  - When not specified as “memory card” or “built-in memory”, the term “memory” by itself refers to both.
  - “Scene” refers to one movie unit from the point you press the  button to start recording until you press again to stop recording.
- The photos included in this manual are simulated pictures taken with a still camera. Unless indicated otherwise, illustrations and menu icons refer to the **HF R52**.

**AUTO** indicates that a function is available in the operating mode indicated and **AUTO** indicates that the function is not available. The operating modes are divided into the following three groups. For a detailed explanation, refer to *Operating Modes* (□ 36).

Brackets [ ] are used to refer to control buttons and menu options you will touch on the screen and to other onscreen messages and displays.

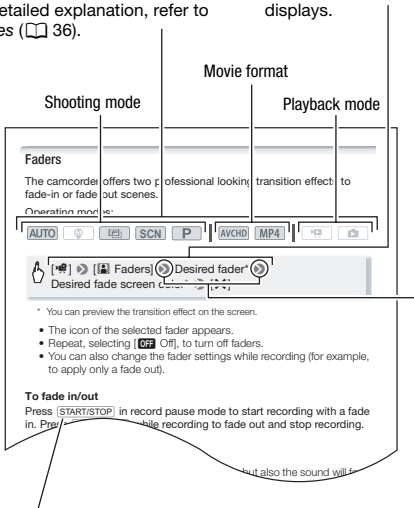

The names of physical buttons and switches on the camcorder are indicated within a "button" frame. For example **[START/STOP]**.

The **➤** arrow is used to abbreviate menu selections. For a detailed explanation on how to use the menus, refer to *Using the Menus* (□ 32). For a concise summary of all available menu options and settings, refer to the appendix *Menu Options Lists* (□ 141).

# Supplied Accessories

The following accessories are supplied with the camcorder:

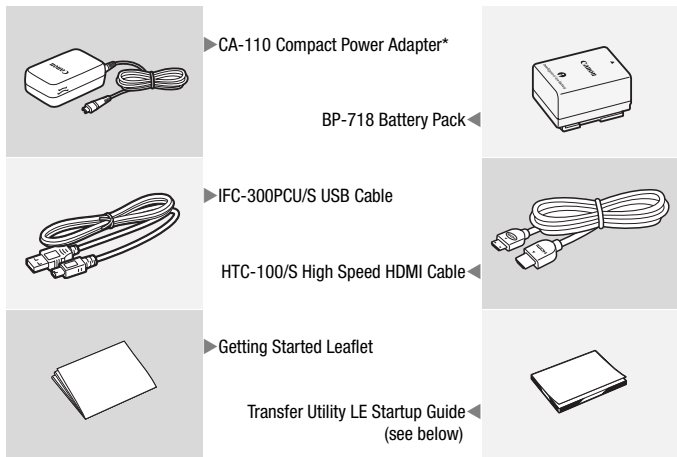

\* CA-110E, including power cord, in Asia.

**Transfer Utility LE Startup Guide:** This guide explains how to download PIXELA's **Transfer Utility LE** software, which allows you to save your AVCHD movies and transfer music files to the camcorder or to a memory card. For details on using the software, refer to the '**Transfer Utility LE Software Guide**' included with the downloaded software.

## **i** NOTES

- The camcorder may make a rattling sound if it is shaken (📖 162).



# Names of Parts

## Left side view

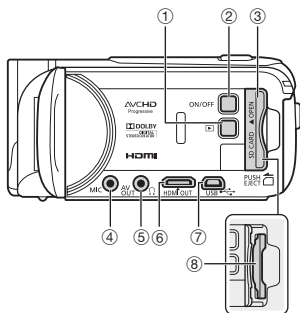

- ▶ (playback mode) button ( 46)
- ON/OFF button
- Memory card slot cover ( 24)
- MIC (microphone) terminal ( 83)
- AV OUT terminal ( 98, 100)/  
⌂ (headphones) terminal ( 82)
- HDMI OUT terminal ( 98, 99)
- USB terminal ( 98, 100)
- Memory card slot ( 24)
- START/STOP button ( 37)
- DC IN terminal ( 20)
- Grip belt

## Right side view

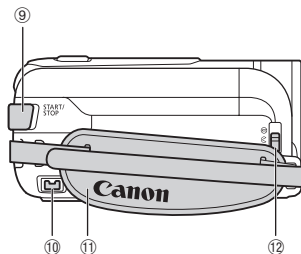

Adjust the grip belt so that you can reach the zoom lever with your index finger, and the **START/STOP** button with your thumb.

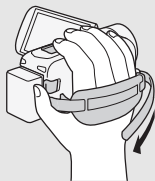

## Front view

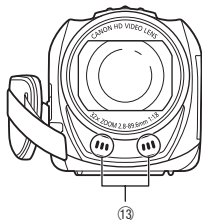

- Lens cover switch

Move the lens cover switch down to ☺ to open the lens cover.



- Stereo microphone ( 144)

## Top view

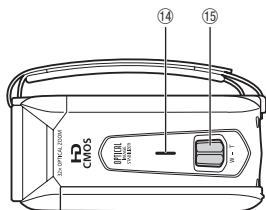

- ⑭ Speaker ( 49)
- ⑮ Zoom lever ( 43)
- ⑯ ACCESS indicator ( 37, 40)
- ⑰ **HFR52/R50** Wi-Fi antenna ( 119)

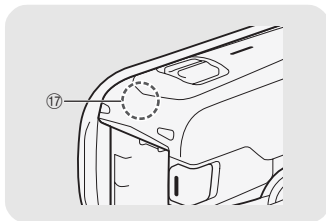

## Back view

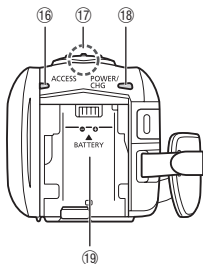

- ⑱ POWER/CHG (charge) indicator:  
Green - On  
Red - Charging ( 20)
- ⑲ Battery attachment unit ( 20)
- ⑳ **Serial number**

## Bottom view

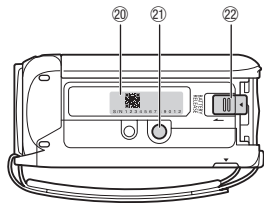

- ㉑ Tripod socket ( 176)
- ㉒ BATTERY RELEASE switch ( 21)

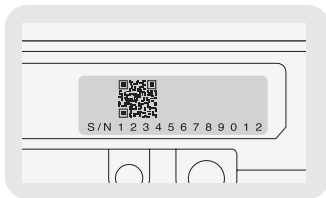

## LCD panel

## 23 LCD touch screen (📖 31)

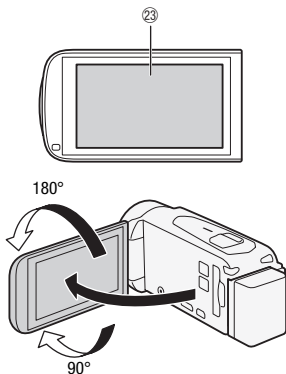

Open the LCD panel 90 degrees. By default, this will turn on the camcorder. The first time you open the LCD panel, the initial setup screens will appear and guide you through the basic settings (📖 26). Adjust the position of the LCD panel according to the recording conditions.

## **i** NOTES

- **About the LCD screen:** The screen is produced using extremely high-precision manufacturing techniques, with more than 99.99% of the pixels operating to specification. Less than 0.01% of the pixels may occasionally misfire or appear as black, red, blue or green dots. This has no effect on the recorded image and does not constitute a malfunction.
- For details about how to take care of the touch screen, refer to *Handling Precautions* (📖 175), *Cleaning* (📖 179).



# Preparations

This chapter describes basic operations, such as using the touch panel, navigating the menus, and first time settings to help you learn more about your camcorder.

## Getting Started

### Charging the Battery Pack

The camcorder can be powered with a battery pack or directly using the compact power adapter.

**1 Plug the compact power adapter into a power outlet.**

For Asia only: Connect the power cord to the compact power adapter before plugging the power cord into the power outlet.

**2 Connect the compact power adapter to the camcorder's DC IN terminal.**

**3 Attach the battery pack to the camcorder.**

Press the battery pack softly into the battery attachment unit and slide it up until it clicks in place.

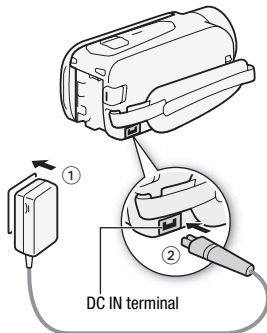

For Asia only:

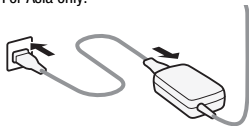

#### 4 Charging will start when the camcorder is turned off.

- If the camcorder was on, the green POWER/CHG indicator will go out when you turn off the camcorder. After a moment, the POWER/CHG indicator will turn on in red (battery pack charging). The red POWER/CHG indicator will go out when the battery pack is fully charged.
- Fully charging the supplied battery pack will take approximately 5 hours and 35 minutes.
- If the indicator flashes, refer to *Troubleshooting* (📖 162).

POWER/CHG (charge) indicator

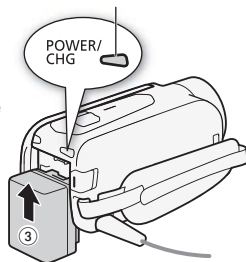

#### To remove the battery pack

- 1 Slide **BATTERY RELEASE** in the direction of the arrow and hold it pressed down.
- 2 Slide the battery pack and then pull it out.

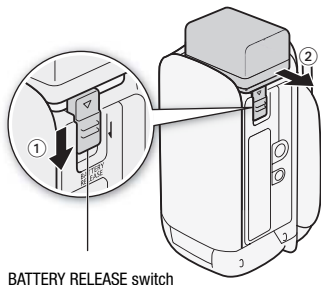





BATTERY RELEASE switch

#### ! IMPORTANT

- Turn off the camcorder before connecting or disconnecting the compact power adapter. After turning off the camcorder, important data is updated in the memory. Be sure to wait until the green POWER/CHG indicator goes out.
- Do not connect to the camcorder's DC IN terminal or to the compact power adapter any electrical equipment that is not expressly recommended for use with this camcorder.

- To prevent equipment breakdowns and excessive heating, do not connect the supplied compact power adapter to voltage converters for overseas travels or special power sources such as those on aircraft and ships, DC-AC inverters, etc.

## NOTES

- We recommend charging the battery pack in temperatures between 10 °C and 30 °C (50 °F and 86 °F). If either the ambient temperature or the battery pack's temperature is outside the range of approx. 0 °C to 40 °C (32 °F to 104 °F), charging will not start.
- If the ambient temperature or the battery pack's temperature is low, charging may take longer than usual.
- The battery pack will be charged only when the camcorder is off.
- If the power supply was disconnected while charging a battery pack, make sure the POWER/CHG indicator has gone out before restoring the power supply.
- If remaining battery time is an issue, you can power the camcorder using the compact power adapter so the battery pack will not be consumed.
- Charged battery packs continue to discharge naturally. Therefore, charge them on the day of use, or the day before, to ensure a full charge.
- Battery packs for this camcorder can display the remaining battery time. The first time you use a battery pack, fully charge it and then use the camcorder until the battery pack is completely exhausted. Doing so will ensure that the remaining recording time will be displayed accurately.
- For details about how to take care of the battery pack, refer to *Battery Pack* (□ 177). For charging times and approximate usage times, refer to the *Reference Tables* (□ 189).
- You can verify the battery charge status of the battery pack with the     [Battery Info] setting.
- We recommend that you prepare battery packs to last 2 to 3 times longer than you think you might need.
- **USA and Canada only:** The Lithium ion/polymer battery that powers the product is recyclable. Please call 1-800-8-BATTERY for information on how to recycle this battery.





# Using a Memory Card

## Memory Cards Compatible for Use with the Camcorder

You can use the following types of commercially available Secure Digital (SD) cards with this camcorder. We recommend using memory cards rated CLASS 4, 6 or 10\*.

As of November 2013, the movie recording function has been tested using SD/SDHC/SDXC memory cards made by Panasonic, Toshiba and SanDisk. For the latest information on memory cards that can be used, visit your local Canon Web site.

Memory card type:  SD memory card,  SDHC memory card,  
 SDXC memory card  
SD Speed Class\*\*: CLASS 4 or better

\* To record movies with a video quality of 60P or 35 Mbps, we recommend using memory cards rated CLASS 6 or 10.

\*\*When using an SD memory card rated CLASS 2 or without a Speed Class rating, you may not be able to record movies, depending on the memory card used.

### IMPORTANT

- After repeatedly recording, deleting and editing scenes (fragmented memory), it will take longer to write data on the memory and recording may stop. Save your recordings and initialize the memory.

### NOTES

- **About the Speed Class:** Speed Class is a standard that indicates the minimum guaranteed data transfer speed of memory cards. When you buy a new memory card, look for the Speed Class logo on the package.

## SDXC Memory Cards

You can use SDXC memory cards with this camcorder. When using memory cards with other devices, such as digital recorders, computers and card readers, **make sure that the external device is compatible with SDXC cards.** For more information on compatibility, contact the computer, operating system or memory card manufacturer.

## ! IMPORTANT

- If you use an SDXC memory card with a computer OS that is not SDXC-compatible, you may be prompted to format the memory card. In such case, **cancel the operation to prevent data loss.**

## Inserting and Removing a Memory Card

To use a memory card for recording, turn off the camcorder and insert the memory card before performing the initial setup. After completing the initial setup, initialize the memory card (📖 29).

### 1 Open the LCD panel.

If this is the first time you turn on the camcorder, the language selection screen of the initial setup screens will appear.

### 2 Press **ON/OFF** to turn off the camcorder.

Make sure the POWER/CHG indicator is off.

### 3 Open the memory card slot cover.

### 4 Insert the memory card at a slight angle, with the label facing toward the lens, all the way into the memory card slot until it clicks.

The memory card slot is at a slight angle toward the lens so be careful not to damage the memory card when inserting it.

### 5 Close the memory card slot cover.

Do not force the cover closed if the memory card is not correctly inserted.

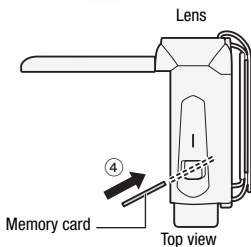
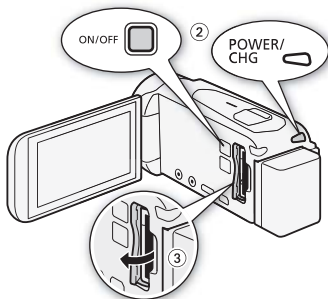



### **To remove the memory card**

Push the memory card once to release it. When the memory card springs out, pull it all the way out.

#### **IMPORTANT**

- Memory cards have front and back sides that are not interchangeable. Inserting a memory card facing the wrong direction can cause a malfunction of the camcorder. Be sure to insert the memory card as described in step 4.

# First Time Settings

## Basic Setup

You can turn the camcorder on and off by opening and closing the LCD panel. The first time you turn on the camcorder, you will be guided by the camcorder's easy-to-follow setup screens to configure the camcorder's initial settings. For details on how to use the touch screen, refer to *Using the Touch Screen* (📖 31).

### 1 Open the LCD panel.

- If this is the first time you turn on the camcorder, the language selection screen of the initial setup screen will appear.
- You can also press **ON/OFF** to turn on the camcorder.

### 2 Touch the language used for onscreen displays and then touch [▷].

- You may need to scroll down to find your language.
- After you select a language, the [Date Format] screen will appear.

Touch [▷] after selecting a language



### 3 Touch [Y.M.D], [M.D,Y] or [D.M.Y] to select the date format you prefer and then touch [▷].

After you select the date format, the [Date/Time] screen will appear with the first field selected.

### 4 Touch a field you want to change (year, month, day, hours or minutes).

### 5 Touch [▲] or [▼] to change the field as necessary.

### 6 Set the correct date and time by changing all the fields in the same way.

- Touch [24H] to use 24-hour clock or leave it unselected to use 12-hour clock (AM/PM).



### 7 Touch [OK] and then touch [▷].

- After you select the date and time, the [Movie Format] screen will appear.

8 Touch **[AVCHD]** or **[MP4]** to select the movie format and then touch **[>]**.

- **HFR52/R50** After you select the movie format, the [ Rec Media for Movies] screen will appear, where you can select the memory to which you want to record movies.
- **HFR500** Skip to step 11.

9 Touch **[]** (built-in memory) or **[SD]** (memory card) and then touch **[>]**.

- When selecting the memory, you can check the available recording time based on the video quality setting.
- After you select the memory to which you want to record movies, the [ Rec Media for Photos] screen will appear.

10 Touch **[]** (built-in memory) or **[SD]** (memory card) and then touch **[>]**.



When selecting the memory, you can check the number of photos that can be recorded, based on a photo size of 1920x1080.

11 Touch **[OK]**.

- The basic setup is complete. The settings you selected will appear briefly and then the camcorder will be ready to record.
- After completing the basic setup, you can close the LCD panel or press **[ON/OFF]** to turn off the camcorder.

## NOTES

- Some buttons, such as **[ZOOM]** or **[PHOTO]**, will appear in English regardless of the language selected.
- You can change the language later on with the **[>]** **[>]** [**Language** ] setting. You can adjust the date and time later on with the **[>]** **[>]** [**Date/Time** ] setting. You can change the movie format later on with the **[>]** [**Movie Format** ] setting. **HFR52/R50** You can select the memory for movies and photos later on with the **[>]** [**Recording Media** ] **[>]** [**Rec Media for Movies** ] and [**Rec Media for Photos** ] settings.

- When you do not use the camcorder for about 3 months, the built-in rechargeable lithium battery may discharge completely and the date and time setting may be lost. In such case, recharge the built-in lithium battery (📖 178). The next time you turn on the camcorder, you will have to configure the initial settings again.
- You can change the  ➤  ➤ [Power On Using LCD Panel] setting so that you can turn the camcorder on and off only by pressing .

## Changing the Time Zone





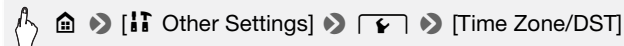

Change the time zone to match your location. The default setting is New York. In addition, the camcorder is able to retain the date and time of another location. This is convenient when you travel so that you can set the camcorder to match the time of your home location or that of your destination.

Operating modes:



- 1 Open the [Time Zone/DST] screen.



- 2 Touch [] to set the home time zone, or [] to set the time zone of your destination when you are traveling.
- 3 Touch [] or [] to set the desired time zone. If necessary, touch [] to adjust for daylight saving time.
- 4 Touch [] to close the menu.

## Initializing the Memory

Initialize memory cards when you use them with this camcorder for the first time. You can also initialize a memory card or the built-in memory (HFR52/R50 only) to permanently delete all the recordings it contains.

**HFR52/R50** At the time of purchase, the built-in memory comes pre-initialized and contains music files for use as background music and images for use with the image mix function (image mix frames).

Operating modes:



### 1 Power the camcorder using the compact power adapter.

Do not disconnect the power source or turn off the camcorder until the initialization is completed.

### 2 Initialize the memory.

#### HFR52/R50

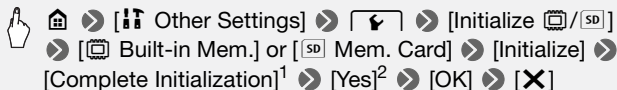

#### HFR500

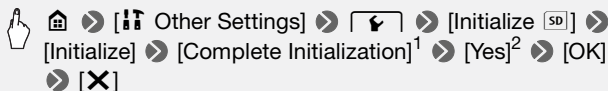

<sup>1</sup> Touch this option if you want to physically erase all the data rather than just clear the file allocation table of the memory.

<sup>2</sup> If you selected the [Complete Initialization] option, you can touch [Cancel] to cancel the initialization while it is in progress. All recordings will be erased and the memory can be used without any problem.

## IMPORTANT

- Initializing the memory will permanently erase all recordings. Lost original recordings cannot be recovered. Make sure you save important recordings in advance using an external device (📖 103).
- Initializing a memory card will permanently erase any music files and images you may have transferred to the card. (**HFR52/R50** The music files and image mix frames that come pre-installed in the built-in memory will be restored after it is initialized.)

# Basic Operation of the Camcorder

## Using the Touch Screen

The control buttons and menu items that appear on the touch screen change dynamically depending on the operating mode and the task you are performing. With the intuitive touch screen interface you have all the controls at your fingertips.

### Touch

Touch on an element displayed on the touch screen.

Used to start playing back a scene in an index screen, to select a setting from the menus, etc.

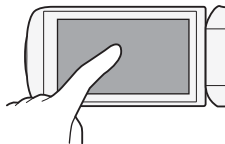

### Drag

While touching the screen, swipe your finger up and down or left and right across the screen.

Used to scroll menus, to browse through index screen pages or to adjust slider controls like the volume.

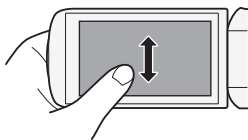

### ! IMPORTANT

- In the following cases, you may not be able to perform touch operations correctly.
  - Using your fingernails or hard-tipped objects, such as ballpoint pens.
  - Operating the touch screen with wet or gloved hands.
  - Applying excessive force with your finger.

## Using the Menus



Many of the camcorder's functions can be adjusted from the menus in the  (Home) menu. In addition, you will find it useful to learn how to navigate the other menus as well so that you can access all that your camcorder has to offer.

### (Home) Menu

The  (Home) menu is the gateway to most of the camcorder's functions and settings.

Operating modes:



- 1 Touch [] on the upper left of the screen to open the  (Home) menu.
- 2 Drag your finger left/right to bring the desired menu to the center.
- 3 Touch the icon of the desired menu to open it.

See below for a description of each menu. The menus that appear depend on whether the camcorder is in recording mode or playback mode.

In recording mode





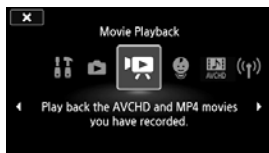















In playback mode





## Available Menus



| Menu item<br>Description                                                                                                                                                                                                                                                                                                                                                                                                                                                                                                               |  |
|----------------------------------------------------------------------------------------------------------------------------------------------------------------------------------------------------------------------------------------------------------------------------------------------------------------------------------------------------------------------------------------------------------------------------------------------------------------------------------------------------------------------------------------|----------------------------------------------------------------------------------|
| <p> Other Settings]</p> <p>Opens the [ Other Settings] menus, which give you access to various camcorder settings.</p>                                                                                                                                                                                                                                               | 35, 146                                                                          |
| <p> Recording Setup] (recording mode only)</p> <p>In this menu you can select the movie format, video quality, memory used for recording*, and whether to use dual recording* or relay recording*.</p>                                                                                                                                                                                                                                                | 56 - 59                                                                          |
| <p>[Shooting Mode]** (recording mode only)</p> <p>The camcorder features a number of shooting modes that offer the most appropriate settings for a variety of scenes.</p>                                                                                                                                                                                                                                                                                                                                                              | 59                                                                               |
| <p> Main Functions] (recording mode only)</p> <p>This menu contains functions commonly used while recording, such as focus and exposure. The [] button on the right side of the recording screen allows you to open this menu directly, without going through the  (Home) menu.</p> | 142                                                                              |
| <p> Remote Control+Streaming] (recording mode only)</p> <p>Use your smartphone or tablet as a remote control to record with the camcorder. You can also stream video from the camcorder and record it on the smartphone or tablet.</p>                                                                                                                                                                                                                | 120                                                                              |
| <p> Photo Playback] (playback mode only)</p> <p>Switches the camcorder to photo playback mode and opens the [] index screen.</p>                                                                                                                                                                                                                                     | 50                                                                               |
| <p> Movie Playback] (playback mode only)</p> <p>Switches the camcorder to movie playback mode and opens the [] index screen.</p>                                                                                                                                                                                                                                  | 46                                                                               |
| <p> Baby Album] (playback mode only)</p> <p>Switches the camcorder to playback mode and opens the [] index screen, which displays only the scenes you recorded using  mode.</p>                                                                                               | 46                                                                               |

| Menu item<br>Description                                                                                                                                                                                                                                                                                                                                |  |
|---------------------------------------------------------------------------------------------------------------------------------------------------------------------------------------------------------------------------------------------------------------------------------------------------------------------------------------------------------|---------------------------------------------------------------------------------|
|  Video Snapshot] (playback mode only)<br>Switches the camcorder to movie playback mode and opens the  index screen, which displays only video snapshot scenes recorded in AVCHD format. | 46                                                                              |
|  Wi-Fi]* (playback mode only)<br>Allows you to access the various Wi-Fi functions, such as uploading recordings to the Web or playing back recordings using a smartphone.                                                                                                | 117                                                                             |

\* **HFR52/R50** only.

\*\*The icon shown in the  (Home) menu indicates the shooting mode currently selected.

## Using the Menus

Changing the camcorder's various settings using the menus is very easy. You make your selection simply by touching the button of the desired option. When they appear on the screen, you can touch  to return to the previous screen or  to close the menu.

In some screens, you will need to scroll to find the desired option.



Some screens provide additional information about the options. In that case, simply drag your finger up and down along the column of icons.

Touch to scroll up  
or down



Drag your finger up  
and down along the  
scroll bar to display  
the rest of the panel

Touch the control  
button of the  
desired function

## Using the [ⓘ] Other Settings] Menus

Refer to [ⓘ] Other Settings] Menus (📖 146) for available functions.

Operating modes:







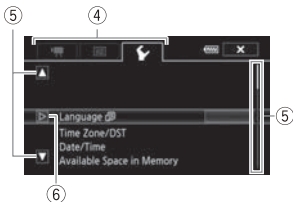

\* In **AUTO** mode, access to functions is limited.

- 1 Touch [🏠] on the upper left of the screen to open the 🏠 (Home) menu.
- 2 Drag your finger left/right to bring [ⓘ] Other Settings] to the center.
- 3 Touch the icon to open the [ⓘ] Other Settings] menus.
- 4 Touch the tab of the desired menu.
- 5 Drag your finger up/down to bring the setting you want to change into the orange selection bar.
  - You can also use the [▲] and [▼] icons for scrolling.
  - You can touch any menu item on the screen to bring it directly into the selection bar.
- 6 When the desired menu item is inside the selection bar, touch [▶].
- 7 Touch the desired option and touch [✕].



## NOTES



- You can touch [**X**] to close the menu at any time.
- Menu items not available appear grayed out.
- For brevity's sake, references to settings in the  (Home) menu will include only the icon of the menu, the tab of the desired submenu (for settings in the [ Other Settings] menu) and the setting name. For example, "the [    [LCD Brightness] setting".









## Operating Modes

In this manual, the camcorder's operating modes are indicated with a bar of icons. Icons are divided into three areas as follows.



The icons in the **recording** area correspond to the shooting mode you can select ( 59).

The icons in the **movie format** area refer to AVCHD or MP4 recordings. While recording, you can change the movie format as described in *Selecting the Movie Format (AVCHD/MP4)* ( 56). During playback, use the index screen button ( 46) to switch between playback of AVCHD movies and MP4 movies.

In the **playback** area of the operating modes bar, the  icon refers to playing back movies ( 46), whether from the [] index screen (all scenes), the [] index screen (only scenes recorded in  mode) or the [] index screen (only video snapshot scenes recorded in AVCHD format). The  icon refers to viewing photos from the [] index screen ( 50).

## NOTES

- **HFR52/R50** When switching to a playback mode, the memory selected for playback will be the same currently used for recording.



# Basic Shooting and Playback

This chapter covers how to record video and photos, how to use the convenient **AUTO** mode and other basic functions. To enjoy full access to menus and more advanced functions, refer to *Advanced Shooting* (📖 56) and *Advanced Playback and Editing* (📖 85).

## Basic Recording

### Shooting Video

You can easily record movies with the camcorder.

Operating modes:



#### ✔ POINTS TO CHECK

- **Before you begin recording**, make a test recording first to check that the camcorder is operating correctly.

#### 1 Open the LCD panel to turn on the camcorder.

- You can also press **ON/OFF**.
- **HFR52/R50** By default, movies are recorded in the built-in memory. You can select the memory that will be used to record movies (📖 58).
- By default, the camcorder will record in **AUTO** mode. You can select a different shooting mode according to the shooting conditions (📖 59).

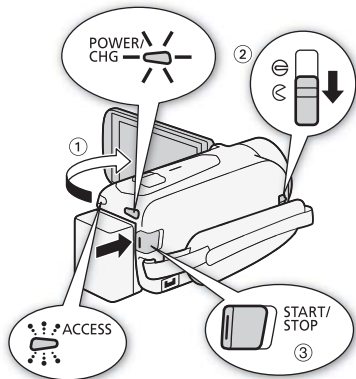

2 Slide the lens cover switch down.

3 Press **START/STOP** to begin recording.

- Press **START/STOP** again to stop recording.
- The ACCESS indicator will flash from time to time while the scene is being recorded.

**Recording standby:**

**While recording:**

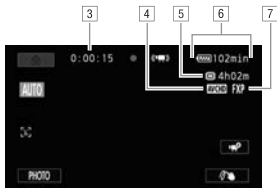
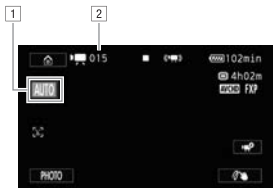

- 1 Shooting mode (📖 59)
- 2 Number of scenes recorded
- 3 Scene counter (hours : minutes : seconds)
- 4 Video format (📖 56)
- 5 Remaining recording time on the memory
- 6 Remaining battery charge
- 7 Video quality (📖 56)

**When you have finished recording**









- 1 Make sure that the ACCESS indicator is off.
- 2 Close the LCD panel to turn off the camcorder.  
You can also press **ON/OFF**.
- 3 Slide the lens cover switch up.

### **!** IMPORTANT

- To protect the lens, keep the lens cover closed when you are not recording.
- Observe the following precautions while the ACCESS indicator is on or flashing. Failing to do so may result in permanent data loss or damage to the memory.

- Do not open the memory card slot cover.
- Do not disconnect the power source or turn off the camcorder.
- Do not change the camcorder's operating mode.
- Be sure to save your recordings regularly (📖 103), especially after making important recordings. Canon shall not be liable for any loss or corruption of data.

## NOTES

- **About the power saving mode:** If  ➤  ➤ [Auto Power Off] is set to [ON On], the camcorder will shut off automatically to save power when it is powered by a battery pack and is left without any operation for 3 minutes. Should this happen, turn the camcorder back on.
- When recording in bright places, it may be difficult to use the LCD screen. In such cases, you can adjust the LCD backlight with the  ➤  ➤ [LCD Backlight] setting or adjust the brightness of the LCD screen with the  ➤  ➤ [LCD Brightness] setting.
- If you plan on making a long recording while the camcorder is in a fixed position, such as on a tripod, you can record with the LCD panel closed in order to conserve the battery's power. In such case, make sure  ➤  ➤ [Power On Using LCD Panel] is set to [Off].

## Taking Photos

You can easily take photos with the camcorder. You can even take photos simultaneously while recording a movie.

Operating modes:



### 1 Open the LCD panel to turn on the camcorder.

- You can also press **ON/OFF**.
- **HFR52/R50** By default, photos are recorded in the built-in memory. You can select the memory that will be used to record photos ( 58).
- By default, the camcorder will record in **AUTO** mode. You can select a different shooting mode according to the shooting conditions ( 59).

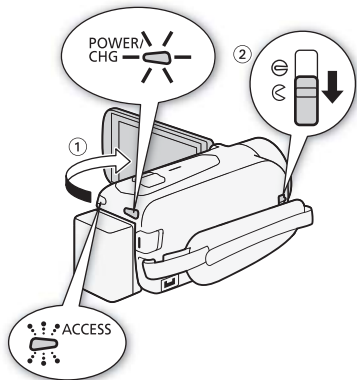

### 2 Slide the lens cover switch down.

### 3 Touch [PHOTO] to take a photo.

A green icon (⊙) and (HFR52/R50 only) or will appear momentarily on the screen and the ACCESS indicator will flash as the photo is recorded. However, if you record a photo while recording a movie, ⊙ will not appear.



## When you have finished taking photos

- 1 Make sure that the ACCESS indicator is off.
- 2 Close the LCD panel to turn off the camcorder.  
You can also press **ON/OFF**.



### 3 Slide the lens cover switch up.

#### IMPORTANT

- The information in the IMPORTANT section (📖 38) and NOTES section (📖 39) on the previous pages also apply to photos.

#### NOTES

- Photos are recorded as JPG files. For details about the approximate number of photos that can be recorded on a memory card, refer to the *Reference Tables* (📖 189).
- Photos cannot be recorded while fading in or fading out a scene.

---

## AUTO Mode

**AUTO** mode is the camcorder's default shooting mode. Using **AUTO** mode, you can record great-looking movies and photos by letting the camcorder adjust the necessary settings according to the recording situation. In **AUTO** mode, most advanced settings will not be available but you can use the following functions.

- Intelligent IS (📖 43).
- Zoom (📖 43).
- Video snapshot (📖 71).
- Decoration (📖 65) to add a fun personal touch using stamps, drawings, image mix and more.
- Face detection and tracking (📖 72) to get beautiful shots of people every time, tracking the subject even if the person moves.
- Faders (📖 74).
- Audio scenes (📖 81).
- Pre-recording (📖 144).

Operating modes:

**AUTO**



**SCN**

**P**

**AVCHD**

**MP4**



## Smart AUTO

In **AUTO** mode, the camcorder will automatically detect certain characteristics of the subject, background, lighting conditions, etc. It will then adjust various settings (focus, exposure, color, image stabilization, image quality, among others), selecting the best settings for the scene you want to shoot. The Smart AUTO icon will change to one of the following icons.

### Smart AUTO icons

| Background →<br>(color of the icon)               | Bright*<br>(gray) | Blue skies*<br>(light blue) | Vivid colors*<br>(green/red) | Sunsets<br>(orange) |
|---------------------------------------------------|-------------------|-----------------------------|------------------------------|---------------------|
| Subject ↓                                         |                   |                             |                              |                     |
| People (stationary)                               |                   |                             |                              | —                   |
| People (moving)                                   |                   |                             |                              | —                   |
| Subjects other than people,<br>such as landscapes | <b>AUTO</b><br>   | <b>AUTO</b><br>             | <b>AUTO</b><br>              |                     |
| Close objects                                     |                   |                             |                              | —                   |



| Background →<br>(color of the icon)               | Dark<br>(dark blue) |           |             |
|---------------------------------------------------|---------------------|-----------|-------------|
| Subject ↓                                         |                     | Spotlight | Night scene |
| People (stationary)                               |                     | —         | —           |
| People (moving)                                   |                     | —         | —           |
| Subjects other than people,<br>such as landscapes | <b>AUTO</b>         |           |             |
| Close objects                                     |                     | —         | —           |





\* The icon in parentheses appears under backlight conditions.





### NOTES

- Under certain conditions, the Smart AUTO icon that appears on the screen may not match the actual scene. Especially when shooting against orange or blue backgrounds, the Sunset or one of the Blue Skies icons may appear and the colors may not look natural. In such case, we recommend recording in **P** mode ( 64).









## Intelligent IS

Intelligent IS allows the camcorder to select the best image stabilization option based on your shooting method. During **AUTO** and  mode, the Intelligent IS icon will change to one of the following icons. In other shooting modes, you can set the image stabilization manually ( 148).

| Shooting method                                                                                                        | Icon                                                                                            |
|------------------------------------------------------------------------------------------------------------------------|-------------------------------------------------------------------------------------------------|
| Most general situations; Zooming out (zooming toward <b>W</b> ); Following subjects at a distance moving left or right |  (Dynamic IS)  |
| Zooming in (zooming toward <b>T</b> ), while remaining stationary, on subjects at a distance                           |  (Powered IS)* |
| Close-up of a subject                                                                                                  |  (Macro IS)    |
| When using a tripod                                                                                                    |  (tripod mode) |

\* You can use the     [Intelligent IS] setting to change whether Powered IS is available when Intelligent IS is activated.

## Zooming

There are two ways you can zoom in and out: using the zoom lever on the camcorder or using the zoom controls on the touch screen. In modes other than **AUTO**, you can select the zoom type (optical, advanced or digital) with the   [Zoom Type] setting ( 143). You can also change the zoom speed with the     [Zoom Speed] setting ( 147).

Operating modes:



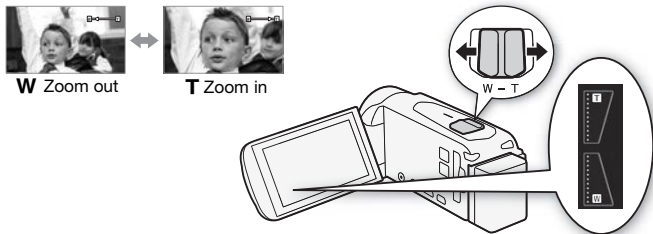

### Using the Zoom Lever

Move the zoom lever toward **W** (wide angle) to zoom out. Move it toward **T** (telephoto) to zoom in.

### Using the Touch Screen's Zoom Controls





1 Display the zoom controls on the touch screen.



- The zoom controls appear on the left side of the screen.
- 2 Touch the zoom controls to operate the zoom.
- Touch anywhere within the **W** area to zoom out or anywhere within the **T** area to zoom in. Touch closer to the center for a slow zoom; touch closer to the **W/T** icons for faster zooms.
  - While the zoom controls are displayed, you can touch [●] to start recording a movie. Touch [■] to stop recording. You can also touch [PHOTO] to record a photo.
- 3 Touch [X] to hide the zoom controls.

### **i** NOTES

- Keep at least 1 m (3.3 ft.) away from the subject. At full wide angle, you can focus on a subject as close as 1 cm (0.39 in.). Using tele macro (80), you can focus on a subject as close as 50 cm (1.6 ft.) at full telephoto.

- When  >  > [Zoom Speed] is set to [VAR Variable], the zoom speed will be faster in recording standby mode than when actually recording, except when pre-recording ( 144) is activated.
- With the  >  > [Zoom Position at Startup] setting, you can tell the camcorder to memorize the zoom position when you turn it off, so the zoom position will be the same the next time you turn on the camcorder.



# Basic Playback

## Playing Back Video

Operating modes:



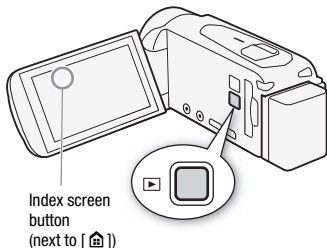

### 1 Press .

- You can press  repeatedly to switch back and forth between recording mode and playback mode.
- You can press  when the camcorder is off to turn it on directly in playback mode.
- The [] index screen, which contains all the scenes you have recorded, will open.



### 2 In the index screen, look for the scene you wish to play back.

- To open the [] index screen (only video snapshot scenes recorded in AVCHD format) or the [] index screen (baby album with only scenes recorded in  mode):

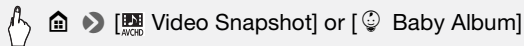



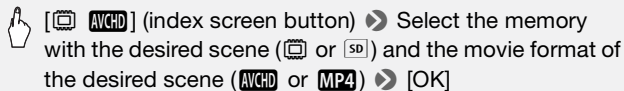

- To change the memory from which to play back (**HFR52/R50** only) or the video format of the scenes you wish to play back:

**HFR52/R50**



 [**SD** **AVCHD**] (index screen button) ➤ Movie format of the desired scene (**AVCHD** or **MP4**) ➤ [OK]



- 1 Index screen button. Displays the currently selected memory (**HFR52/R50** only) and movie format. Press to change the index screen.
- 2 Drag your finger left/right for the next/previous index page.
- 3 Display the next/previous index page.
- 4 Recording date (for AVCHD movies) or folder name (for MP4 movies,  153).
- 5  Scene's timeline (for AVCHD movies,  89).  
 Scene information (for MP4 movies,  49).

### 3 Touch the desired scene to play it back.

- The camcorder will play back the scene selected and continue until the end of the last scene in the index screen.
- Touch the screen to display the playback controls. During playback, the playback controls will disappear automatically after a few seconds without operation.

## During playback:

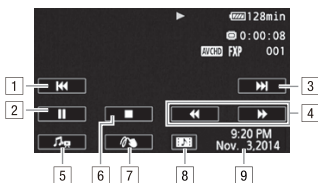

- 1 Jump to the beginning of the scene. Double-tap to jump to the previous scene.
- 2 Pause the playback.
- 3 Jump to the beginning of the next scene.
- 4 Fast playback\* backward/forward.
- 5 Display the volume (📖 49) and background music mix balance (📖 87) controls.
- 6 Stop the playback.
- 7 Decoration (📖 65).
- 8 Capture a video snapshot scene from this movie (📖 85).
- 9 Recording date (for AVCHD movies) or the date the recording started (for MP4 movies).

\* Touch several times to increase the playback speed to approximately 5x → 15x → 60x normal speed.



## During playback pause:

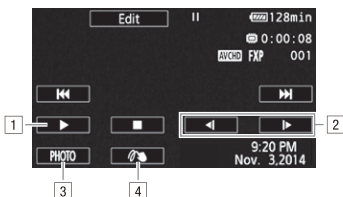

- 1 Resume playback.
- 2 Slow playback\* backward/forward.
- 3 Capture the displayed frame as a photo (📖 86).
- 4 Decoration (📖 65).

\* Touch several times to increase the playback speed 1/8 → 1/4 the normal speed.

## Adjusting the volume

- 1 During playback, touch the screen to display the playback controls.
- 2 Touch [🎵], touch [🔊] or [🔊] to adjust the volume, and touch [↶].

## Displaying scene information for MP4 movies

On the scene information screen you can check various details, including the scene's length, date and time of recording and video quality.

- 1 In the [📺] index screen for MP4 movies, touch [i].
- 2 Touch the desired scene.
  - The [Scene Info] screen appears.
  - Touch [◀]/[▶] to select the previous/next scene.
- 3 Touch [↶] twice when finished.

### ! IMPORTANT

- Observe the following precautions while the ACCESS indicator is on or flashing. Failing to do so may result in permanent data loss.
  - Do not open the memory card slot cover.

- Do not disconnect the power source or turn off the camcorder.
- Do not change the camcorder's operating mode.
- You may not be able to play back with this camcorder movies recorded on a memory card using another device.

## **i** NOTES

- You can play back video snapshot scenes recorded in AVCHD format from the [ ] index screen (all scenes) or from the [ ] index screen (only video snapshot scenes). Video snapshot scenes recorded in MP4 format can be played back only from the [ ] index screen.
- You can use the [ ] [ ] [ ] [ ] [Display Date/Time] setting to choose whether to display the recording date when you play back videos.
- Depending on the recording conditions, you may notice brief stops in video or sound playback between scenes.
- During fast/slow playback, you may notice some anomalies (blocky video artifacts, banding, etc.) in the playback picture. Also, sound will not be output.
- The speed indicated on the screen is approximate.
- Slow reverse playback will look the same as continuous frame reverse.
- Sound will not be output from the built-in speaker while the supplied High Speed HDMI cable or optional STV-250N Stereo Video Cable is connected to the camcorder.

## Viewing Photos

Operating modes:



1 Press [ ] .

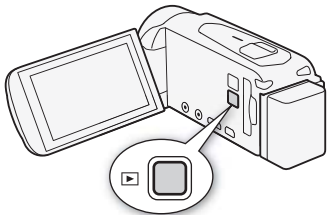

## 2 Open the [📷] index screen.



## 3 **HFR52/R50** If necessary, change the memory from which to play back.

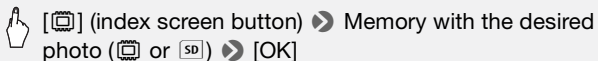

- HFR52/R50** Index screen button. Displays the currently selected memory. Press to change the index screen.
- Drag your finger left/right for the next/previous index page.
- Display the next/previous index page.
- Folder name (📁 153).

## 4 Look for the photo you want to play back.

## 5 Touch the photo you wish to view.

- The photo is displayed in single photo view.
- Drag your finger left/right to browse through the photos one by one.

## During single photo view:

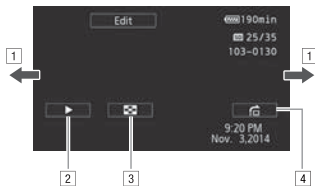

- 1 Drag your finger left/right for the next/previous photo.
- 2 Start a slideshow of your photos (📖 94).
- 3 Return to the [📷] index screen.
- 4 Display the [Photo Jump] scroll bar. Drag your finger along the scroll bar to jump easily and quickly through a large number of photos. Touch [↶] to return to single photo view.

### ! IMPORTANT

- Observe the following precautions while the ACCESS indicator is on or flashing. Failing to do so may result in permanent data loss.
  - Do not open the memory card slot cover.
  - Do not disconnect the power source or turn off the camcorder.
  - Do not change the camcorder's operating mode.
- The following image files may not be displayed correctly.
  - Images not recorded with this camcorder.
  - Images edited on a computer.
  - Images whose file names have been changed.

## Deleting Recordings

You can delete those scenes and photos that you are not interested in keeping. Deleting unnecessary recordings allows you also to free up space on the memory.

### Deleting Recordings from the Index Screen

Operating modes:



#### 1 Open the desired index screen (📖 46, 50).

To delete all the scenes/photos recorded on a specific date, drag your finger left/right until a scene or photo you want to delete appears.

#### 2 Delete the recordings.

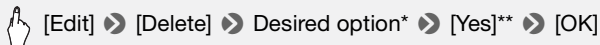

\* When you select [Select], perform the following procedure to select the individual recordings you want to delete before touching [Yes].

\*\*Touch [Stop] to interrupt the operation while it is in progress. Some scenes/photos may be deleted nevertheless.

### To select individual recordings

#### 1 Touch on the individual scenes/photos you want to delete.

- A checkmark ✓ will appear on the recordings you touch. The total number of selected recordings will appear next to the icon.
- Touch a selected scene or photo to remove the checkmark. To remove all checkmarks at once, touch [Remove All] ➤ [Yes].

#### 2 After selecting all the desired recordings, touch [OK].

## Options

**[date/folder name]** Delete all the scenes/photos recorded on a particular date. For AVCHD movies, the date will appear in the control button. For MP4 movies and photos, the folder name\* (📁 153) will appear.

**[Select]** Select individual recordings to delete.

**[All Scenes]** Delete all the scenes.

**[All Photos]** Delete all the photos.

\* The last four digits of the folder name indicate the date the folder was created.

## Deleting a Single Scene

---

Operating modes:



- 1 Play back the desired scene (📖 46).
- 2 Touch the screen and then touch [⏸] to pause the playback.
- 3 Delete the scene.

 [Edit] ➤ [Delete] ➤ [Yes] ➤ [OK]

## Deleting a Single Photo

---

Operating modes:



- 1 In single photo view, select the photo you want to delete.
- 2 Touch the screen to display the playback controls.
- 3 Delete the photo.

 [Edit] ➤ [Delete] ➤ [🗑️ Proceed] ➤ [Yes]

- 4 Drag your finger left/right to select another photo to delete or touch [✕].

## IMPORTANT

- Be careful when deleting recordings. Once deleted, recordings cannot be recovered.
- Save copies of important recordings before deleting them ( 105).
- Observe the following precautions while the ACCESS indicator is on or flashing (while recordings are being deleted).
  - Do not open the memory card slot cover.
  - Do not disconnect the power source or turn off the camcorder.
  - Do not change the camcorder's operating mode.
- Photos that were protected with other devices cannot be deleted with this camcorder.

## NOTES

- To delete all recordings and make all recordable space available again you may prefer to initialize the memory ( 29).



# Advanced Shooting

This chapter covers advanced shooting functions, such as Special Scene modes and Baby mode. For details about basic video shooting, refer to *Basic Shooting and Playback* (📖 37).

## Selecting the Movie Format (AVCHD/MP4)

You can choose to record movies in AVCHD or MP4 format. AVCHD movies are ideal for playback with fantastic picture quality. MP4 movies are versatile and can easily be played back on smartphones or uploaded to the Web.

Operating modes:

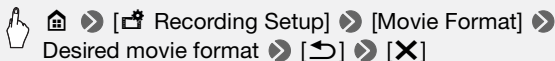

## Selecting the Video Quality

The camcorder offers several video quality options (measured by bit rate\*) for recording movies. For AVCHD movies, select 60P or MXP for higher quality and select LP for longer recording times. Similarly, for MP4 movies, select 35 Mbps or 24 Mbps for higher quality and 4 Mbps for longer recording times.

\* Bit rate indicates how much information is recorded in 1 second of video and also affects recording time available on the memory. Movies with higher bit rates will have higher video quality while those with lower bit rates will have smaller file sizes, allowing you to record longer and upload more quickly.

Operating modes:





\* You can view information on the video quality with the following procedure.



## To view information on the video quality

1 Touch [  ].

A screen with the resolution, bit rate and frame rate will appear.

2 Touch [  ].

### NOTES

- For details about approximate video recording times, refer to the *Reference Tables* (  188).
- If you select 60P or 35 Mbps, movies will be recorded at 60 frames per second, progressive.
- Depending on the external device used for playback, you may not be able to play back your recordings.
- Movies recorded in 60P or MXP mode cannot be saved on AVCHD discs. Use an external Blu-ray Disc recorder compliant with AVCHD Ver. 2.0 specifications to copy those movies onto Blu-ray discs.
- The camcorder uses a variable bit rate (VBR) to encode video so the actual recording times will vary depending on the subject.
- The following types of MP4 scenes will be recognized as multiple files on other devices.
  - Scenes exceeding 4 GB.
  - Scenes recorded at 35 Mbps exceeding 30 minutes.
  - Scenes recorded at a video quality other than 35 Mbps exceeding 1 hour.
- Depending on the TV, you may not be able to play back movies recorded in 60P or 35 Mbps.
- When the video quality is set to 60P or 35 Mbps, dual recording, decoration and faders are not available.
- When the shooting mode is set to  , recording in 60P or 35 Mbps is not available. When the shooting mode is set to  , recording in 60P is not available.

## HF R52/R50 Selecting the Memory (Built-in Memory/Memory Card) for Recordings

You can select to record your movies and photos in the built-in memory or on a memory card. The default memory for recording both is the built-in memory.

Operating modes:

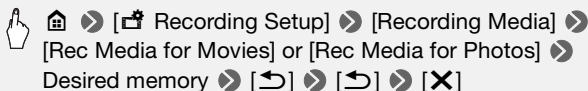

## HF R52/R50 Dual Recording and Relay Recording

When you record, you can use dual recording to simultaneously record one more movie (in MP4 format, at 4 Mbps video quality) in addition to the main scene being recorded. This additional MP4 movie is saved on the memory not currently selected for recording. Because the resulting movie is in MP4 format, it is ideal for transferring to another device or uploading to the Web.

Alternatively, you can activate relay recording so if the assigned memory becomes full while recording movies, the recording will continue automatically on the other memory.



Operating modes:



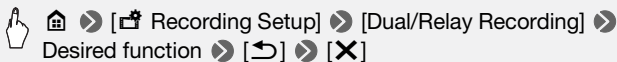

Activate the desired function.



## NOTES

- When you use relay recording, there will be a momentary stop in the scene at the point where the camcorder switches from one memory to another.
- Dual recording is not available in the following cases.
  - When the video quality is set to 60P or 35 Mbps.
  - When the shooting mode is set to  or .
- When dual recording is activated, decoration is not available.

## Shooting Modes





In addition to  mode, the camcorder features a number of shooting modes that offer the most appropriate settings for a variety of special scenes and purposes. You can also use  mode when you want the camcorder to set the initial exposure automatically but still have manual control over some advanced settings.

Operating modes:





\* Except for  mode.

### 1 Touch the shooting mode button on the top left corner of the screen.

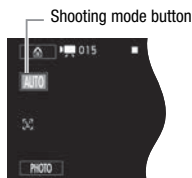

- The button will show the icon of the shooting mode currently selected. If the shooting mode is set to , the button will show one of the Smart AUTO icons ( 42).
- Alternatively, you can open the shooting mode selection screen from the  (Home) menu:   [Shooting Mode].





### 2 Drag your finger up/down to bring the desired shooting mode to the center and then touch [OK].

- If you selected [ Cinema] or [**SCN** Scene], continue the procedure to select the cinema-look filter ( 61) or special scene mode ( 62).

## Options Default value)

**[ Auto]**  Let the camcorder take care of most of the settings while you concentrate on recording. Great for beginners or if you just prefer not to bother with detailed camcorder settings.

**[ Baby]** Use  mode to record all your little one's precious moments ( 60).

**[ Cinema]** Give your recordings a cinematic look and use cinema-look filters to create unique movies ( 61).

**[SCN Scene]** From nightscapes to beaches, have the camcorder select the best settings that match the situation you are in ( 62).

**[P Programmed AE]** Enjoy full access to menus, settings and advanced functions ( 64).

## Baby Mode



With the optimized settings in  mode, baby's skin will appear with vibrant clarity. In addition, you can add a stamp to the video to show how much time has passed since baby was born.

Operating modes:









\* Even if the video format was set to MP4, when you change the shooting mode to , the video format is automatically set to AVCHD.







Touch the shooting mode button ( 59)  [ Baby]

 [OK]

## NOTES

- During  mode, pre-recording ( 144) will be activated and cannot be turned off. That way, you will not miss memorable moments.
- You can play back recordings made in  mode from the [] or [] index screen. The baby album ([] index screen) is particularly convenient because it contains, in chronological order, only the scenes recorded in  mode.

- During  mode, dual recording and recording in 60P are not available.
- In  mode, most advanced settings will not be available but you can use the following functions.
  - Zoom ( 43).
  - Decoration ( 65), including cute stamps, animated stamps and image mix frames especially designed for recording in  mode.



## Cinema Mode and Cinema-Look Filters

In  mode, the camcorder will adjust the frame rate and several other picture-related settings to give your recordings a cinematic look. In this mode you can also use a variety of professional cinema-look filters to create unique movies with a distinctive appearance.

You can also add cinema-look filters when you convert movies to MP4 ( 103).

Operating modes:



Touch the shooting mode button ( 59) ➤ [ Cinema]  
➤ [OK] ➤ Desired cinema-look filter ➤ [OK]

- The selected cinema-look filter will be applied and its number will appear on the control button.

### To change the cinema-look filter

- 1 Touch the [FILTER] button (showing the currently selected cinema-look filter).
- 2 Select the desired cinema-look filter and then touch [OK].

## Options <sup>◆</sup> Default value)

The camcorder offers 7 cinema-look filters. Select the desired filter while previewing the effect on the screen.

[1. Cinema Standard] <sup>◆</sup>

[2. Vivid]

[3. Cool]

[4. Nostalgic]

[5. Sepia]

[6. Old Movies]

[7. Dramatic B&W]

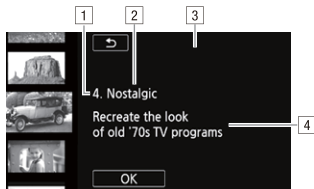

- 1 Filter number (will appear on the control button).
- 2 Filter name.
- 3 Preview the effect on the screen.
- 4 Brief description (onscreen guidance).

## **i** NOTES

- When the shooting mode is set to , the following functions are not available.
  - Taking photos.
  - Decoration.
  - Dual recording.
  - Recording in 60P or 35 Mbps.
  - Monitor from Home, Monitor while Out (using a smartphone or tablet to remotely control the camcorder).

## Special Scene Modes

Recording in a very bright ski resort or capturing the full colors of a sunset or a fireworks display becomes as easy as selecting a Special Scene mode.

Operating modes:





Touch the shooting mode button (📖 59) ➤ [SCN Scene]  
➤ [OK] ➤ Desired Special Scene mode ➤ [OK]

## Options (◆ Default value)

[👤 **Portrait**◆] The camcorder uses a large aperture, to achieve a sharp focus on the subject while blurring the background.



[🏸 **Sports**] To record sports scenes such as tennis or golf.



[🌃 **Night Scene**] To record nightscapes with lower noise.



[❄️ **Snow**] To record in bright ski resorts without the subject being underexposed.



[🏖️ **Beach**] To record on a sunny beach without the subject being underexposed.



[🌅 **Sunset**] To record sunsets in vibrant colors.



[🌑 **Low Light**] To record in low-light situations.



**[A Spotlight]** To record spotlit scenes.



**[🎆 Fireworks]** To record fireworks.



## **i** NOTES

- [👤 Portrait]/[🏊 Sports]/[❄️ Snow]/[🏖️ Beach]: The picture may not appear smooth during playback.
- [👤 Portrait]: The blur effect of the background increases the more you zoom in (**T**).
- [❄️ Snow]/[🏖️ Beach]: The subject may become overexposed on cloudy days or in shaded places. Check the image on the screen.
- [🌑 Low Light]:
  - Moving subjects may leave a trailing afterimage.
  - Picture quality may not be as good as in other modes.
  - White points may appear on the screen.
  - Autofocus may not work as well as in other modes. In such case, adjust the focus manually.
- [🎆 Fireworks]:
  - To avoid camcorder blur (blur due to the camcorder moving) we recommend using a tripod.

## **Programmed AE Mode: Adjusting Settings to Match Your Needs**

Give yourself the most control while shooting by using Programmed AE (AE: auto exposure) shooting mode. As with other shooting modes, the camcorder automatically adjusts the shutter speed and aperture. However, this mode offers you the most versatility by allowing you to adjust other settings to achieve the results you are looking for.

Operating modes:







Touch the shooting mode button (📖 59) ➤

[P Programmed AE] ➤ [OK]

## Decoration: Adding a Personal Touch

Add a new level of enjoyment to your scenes by decorating them. You can add animated graphics, stamps and even your own freehand drawing easily just by simply using your fingertip.

You can also add decorations when you convert movies to MP4 (📖 103).

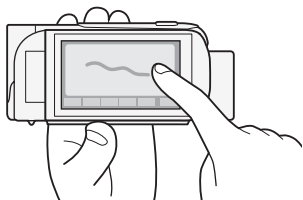

### Decorating Scenes while Recording

Operating modes:









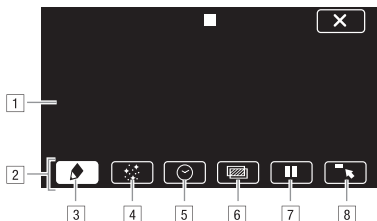





- 1 Touch [] on the bottom right corner of the screen to open the decoration screen.
- 2 Use a tool from the toolbar as explained in the following procedures.
- 3 Press [START/STOP] to record movies with your decorations.  
You can add decorations even while recording a scene.
- 4 Touch [X] to exit the decoration screen.

### NOTES

- [Animated Stamps] and the [Date/Time] or [] stamps cannot be used at the same time.
- Decoration is not available when dual recording is activated or the video quality is set to 60P or 35 Mbps.



- 1 Canvas - The area where you will draw and see your decorations in action.
- 2 Toolbar.
- 3 [  Pens and Stamps] Select the type of pen or stamp and its color.
- 4 [  Animated Stamps] Select animated stamps to add to your decoration.
- 5 [  Date/Time] or [  ] (in  mode) Add the date and/or time as a caption that will be included in the recording. In  mode, add stamps to track baby's age, height and weight.
- 6 [  ] (Image Mix) Choose one of 26 different frames to add onto the canvas.
- 7 [  ] In recording mode: pause the live video. Touch [  ] again to restore the live video. You can add decorations to the frozen image and even record it.  
In playback mode: pause the playback. Touch [  ] to resume playing back the scene.
- 8 [  ] Minimize the toolbar to the top of the screen to view almost all of the canvas. Touch [  ] to restore the toolbar.

### To use [Pens and Stamps]

You can select the color and type of pen for your drawings. You can also save your drawings and stamps as one canvas.

- 1 Touch [  ].

The [Pens and Stamps] screen will appear.

- 2 Touch the desired pen or stamp from the 6 icons on the left.
- 3 Touch the [  ] button (which also shows the currently selected color) and then select the desired color from the [Colors] palette.

#### 4 Touch [OK].

The main decoration screen will appear again.

#### 5 Draw freely on the canvas with your fingertip.

- To clear your freehand drawings and stamps: Touch [] ➤ [Clear] ➤ [Yes] ➤ [OK].
- To save your freehand drawings and stamps: Touch [] ➤ [ Save]<sup>1</sup> or [ Save]<sup>1</sup> ➤ [Yes] ➤ [OK]. During playback, you will need to pause the playback before saving a canvas file.
- To load a previously saved canvas (freehand drawings and stamps only) from the memory: Touch [] ➤ [ Load]<sup>2</sup> or [ Load]<sup>2</sup> ➤ [Yes] ➤ [OK]. During playback, you will need to pause the playback before loading a previously saved canvas file.

<sup>1</sup> The freehand drawings and stamps will be saved in the built-in memory (**HFR52/R50** only) or on a memory card (**HFR500** only).

<sup>2</sup> The camcorder will apply the last freehand drawings and stamps that were saved in the built-in memory (**HFR52/R50** only) or on a memory card (**HFR500** only).

### NOTES

- Initializing a memory will erase any [Pens and Stamps] drawing canvas and image files you may have saved. (**HFR52/R50** The image mix frames that come pre-installed in the built-in memory will be restored after it is initialized.)

### To use [Animated Stamps]

When recording in mode, you can use especially designed, baby-themed animated stamps.

#### 1 Touch [].

The [Animated Stamps] screen will appear.

#### 2 Touch one of the control buttons and then touch [OK].

#### 3 Touch anywhere on the canvas to place the selected animated stamp. You can also drag some animated stamps to a different location.

## To use [Date/Time]

- 1 Touch [🕒].  
The [Date/Time] screen will appear.
- 2 Touch [Date] or [Time].  
To remove a selected stamp, touch it again.
- 3 Touch [OK].  
The selected stamp(s) will appear.
- 4 You can touch any stamp and drag it to the desired location.

## To use stamps from the [👶] menu

During [👶] mode and from the baby album, you can add stamps to the video to track baby's height, weight and age. You can track the information of up to 3 babies.

Operating modes:



- 1 Touch [👶].
  - The screen with stamps for [👶] mode will appear.
- 2 Touch [👶 1], [👶 2] or [👶 3] to select the desired baby.  
The design of the stamps is slightly different for each baby.
- 3 Register baby's information as necessary.
  - To register baby's birth date: Touch [👶] next to the baby's age button. Touch the year\*/month/day, touch [▲]/[▼] to change it, and then touch [OK]. Baby's current age will be calculated and displayed inside the age button.
  - To register baby's height or weight: Touch [👶] next to the button you wish to change. Touch [▲]/[▼] to set the height/weight, and then touch [OK].
    - \* The year of birth can only be set to 2012 and later.
- 4 Touch any of the buttons to add the corresponding stamp: [Date] (the current date), [Time] (the current time), baby's age, height or weight.
  - To remove a selected stamp, touch it again.

5 Touch [OK].

- The selected stamp(s) will appear.

6 You can touch any stamp and drag it to the desired location.



## NOTES

- For the age stamp, days will be displayed for 6 days after birth, weeks will be displayed from 1 week up to, but not including, 1 month; months will be displayed from 1 month up to, but not including, 1 year; years and months will be displayed from 1 year up to, but not including 2 years; and only years will be displayed from 2 years.
- For the height stamp, only inches will be displayed until 35 inches and feet and inches will be displayed from 3 feet.
- For the weight stamp, pounds and ounces will be displayed until 19 pounds 15 ounces and only pounds will be displayed from 20 pounds.

## To use image mix



Image mix frames can be combined with the live video for fun special effects. You can use the image mix function along with additional [Pens and Stamps] or [Animated Stamps] decorations.

The image mix frames are stored in the built-in memory (**HFR52/R50** only). To use the image mix function while recording on a memory card, you will need to download the image mix files and copy them to the memory card in advance ( 192).

Operating modes:



## POINTS TO CHECK

- **HFR52/R50** Before performing this procedure, make sure that the memory selected for recording ( 58) or playback ( 46) contains the image mix frames.

1 Touch [

2 Touch [+] or [-] to select a different image mix frame.

- You can select from 26 image mix frames (or 20 especially designed image frames, in  mode).
  - **HFR52/R50** Only when recording on or playing back scenes from a memory card: You can touch one of the memory icons at the bottom of the screen to read image mix frames saved on a different memory.
- 3 Touch [OK] to mix the selected frame with the live video.

### Mixing Your Own Images with Live Video

You can also use image files you create on your computer for the image mix (Chroma Key) function. Make sure that the image you want to use has a blue or green area, which will be replaced by the live video using Chroma Key mixing. Refer to *About the image files for the Image Mix function* ( 192) for details about the types of image files that can be used and where to transfer them.

Example of an image used for Chroma Key

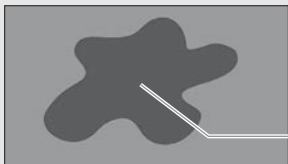

Blue/Green area that will be replaced by the live video

### To use the Chroma Key function

- 1 Open the [Select Image] screen as described in step 1 of the previous procedure.
- 2 Touch [+] or [-] to select the image you created.
- 3 Touch [▶] to open the [Chroma Key] screen.
- 4 Touch [Green] or [Blue] depending on the characteristics of the image you want to use and touch [◀] or [▶] or drag your finger along the bottom bar to adjust the chroma key setting as necessary.
- 5 Touch [OK] to mix your image with live video.

## Decorating Scenes during Playback

You can decorate scenes while playing them back. Decorations added during playback are not recorded with the scene. You can also load and apply a canvas with previously saved decorations.

Operating modes:



- 1 From the index screen (📖 46), play back the scene you want to decorate.

To use the various decorations especially designed for  mode, play back a scene from the baby album ([👶] index screen).

- 2 Touch the screen to display the playback controls.
- 3 Touch [] to open the decoration screen.
- 4 Decorate the scene using the tools from the toolbar as explained in the previous sections.

### NOTES

- The image mix frame cannot be selected during recording or playback.

## Video Snapshot

Record a series of short scenes. When you play back your video snapshot scenes, you can even set them to your favorite music (📖 87) to create your own fun music video. You will be surprised how by changing the background music, you can give your scenes an entirely new feel.

Operating modes:



- 1 Activate video snapshot.





- Touch [OFF] instead to deactivate video snapshot.
- A blue border appears on the screen.

## 2 Press **START/STOP**.

The camcorder records for a few seconds (the blue frame serves as a visual progress bar) and then automatically returns to recording standby mode.

### NOTES

- You can change the length of the video snapshot scene with the   [Video Snapshot Length] setting.
- Any of the following actions will deactivate video snapshot.
  - Turning off the camcorder.
  - Pressing .
  - Changing the movie format (AVCHD/MP4), video quality or frame rate.

## Face Detection and Tracking



The camcorder automatically detects people's faces and uses this information to select the optimal settings for beautiful videos and photos. You can use tracking to tell the camcorder to track and optimize settings for a different person. You can also use tracking to always keep in focus other moving subjects, such as pets or moving vehicles.

Operating modes:



\* Face detection and tracking are always activated in **AUTO** and  modes.

### POINTS TO CHECK

- When the shooting mode is set to **SCN**, select a Special Scene mode other than [  Night Scene], [  Low Light] or [  Fireworks].
- By default, face detection and tracking are activated so you can skip step 1 in the following procedure. If the function was turned off, perform the following procedure starting from step 1.

### 1 Activate face detection and tracking.

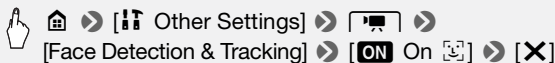



## 2 Point the camcorder at a person.

If there is more than one person in the picture, the camcorder will automatically select one person it determines is the main subject. The main subject is indicated by a white face detection frame and the camcorder will optimize the settings for that person. Other faces will have gray frames.

## 3 Touch a different face on the touch screen to optimize the camcorder's settings for that person.

- You can also touch other moving objects, such as a pet.
- A white double frame will appear around the subject and track it as it moves.
- Touch [Cancel 



Main subject

## NOTES

- The camcorder may mistakenly detect the faces of non-human subjects. In such case, turn face detection off.
- When face detection is activated, the slowest shutter speed used by the camcorder is 1/30 (1/24 if the frame rate is set to 24P).
- Touching somewhere with a color or pattern unique to the subject will make it easier to track. However, if there is another subject in the vicinity that shares similar characteristics to the selected subject, the camcorder may start tracking the incorrect subject. Touch the screen again to select the desired subject.
- In certain cases, faces may not be detected correctly. Typical examples include:
  - Faces extremely small, large, dark or bright in relation to the overall picture.
  - Faces turned to the side, at a diagonal or partially hidden.
- Face detection cannot be used when the shutter speed used is slower than 1/30 (1/24 if the frame rate is set to 24P), when the digital zoom is activated at more than 228x zoom or when using a smartphone or tablet to remotely control the camcorder.
- In certain cases, tracking may not be able to track the subject. Typical examples include:
  - Subjects extremely small or large in relation to the overall picture.
  - Subjects too similar to the background.

- Subjects lacking sufficient contrast.
- Fast moving subjects.
- When shooting indoors with insufficient lighting.

## Faders

The camcorder offers two professional looking transition effects to fade-in or fade-out scenes.

Operating modes:

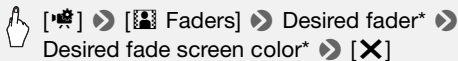

\* You can preview the transition effect on the screen.

- The icon of the selected fader appears.
- Repeat, selecting [**OFF** Off], to turn off faders.
- You can also change the fader settings while recording (for example, to apply only a fade out).

### To fade in/out

Press **[START/STOP]** in record pause mode to start recording with a fade in. Press **[START/STOP]** while recording to fade out and stop recording.

### NOTES

- When you apply a fader, not only the picture but also the sound will fade in or out.
- Faders cannot be used in the following cases:
  - While using the [Old Movies] cinema-look filter in  mode.
  - When recording scenes with decorations.
  - When recording video snapshot scenes.
  - While pre-recording is activated.
  - When the video quality is set to 60P or 35 Mbps.

## Adjusting the Exposure

The camcorder determines the optimal exposure of a scene based on the average brightness of the whole picture. When you want to record a subject that is much brighter or darker than its surroundings, the automatic exposure obtained by the camcorder may not be best for that specific subject.

To correct this, you can compensate the exposure to make the whole picture brighter or darker, you can use Touch AE to tell the camcorder to optimize the exposure for a selected subject, or you can use a combination of both.

Operating modes:



### POINTS TO CHECK

- When the shooting mode is set to **SCN**, select a Special Scene mode other than [ Fireworks].

#### 1 Open the exposure adjustment screen.



### Exposure Compensation

#### 2 Touch **[M]**.

- The exposure is locked and the exposure compensation dial appears with the compensation value set at  $\pm 0$ .
- Touch **[M]** again to return the camcorder to automatic exposure.

#### 3 Touch **[◀]** or **[▶]**, or drag your finger along the dial to compensate the exposure.

- + values will make the picture brighter; – values will make it darker.
- The compensation range may vary depending on the initial brightness of the image, and some values may be grayed out.

#### 4 Touch **[X]** to apply the selected shooting mode and exposure compensation value.

- During exposure lock,  and the exposure compensation value will appear on the screen.

## Touch AE





### 2 Touch a subject that appears inside the frame.

- The Touch AE mark () will flash and the exposure will be optimized automatically for the subject you selected.
- Touch [**M**] to return the camcorder to automatic exposure.

### 3 Touch [**X**] to apply the selected shooting mode and adjusted exposure.

- Using Touch AE also locks the exposure (the exposure compensation dial appears with the compensation value set at  $\pm 0$ ). Before touching [**X**], you can compensate the exposure further (steps 3 and 4 in the previous procedure).
- During exposure lock,  and the exposure compensation value will appear on the screen.

## NOTES

- If the shooting mode is changed during exposure lock, the camcorder will return to automatic exposure.
- By default, the camcorder corrects for backlight conditions. You can turn off the automatic correction with the     [Auto Backlight Correction] setting.

## Adjusting the Focus

Autofocus may not work well on the following subjects. In such case, focus manually.

- |                                                           |                        |
|-----------------------------------------------------------|------------------------|
| • Reflective surfaces                                     | • Fast moving subjects |
| • Subjects with low contrast<br>or without vertical lines | • Through wet windows  |
|                                                           | • Night scenes         |

Operating modes:



## POINTS TO CHECK

- Adjust the zoom before you start the procedure.

### Manual Focus







#### 1 Open the manual focus screen.



#### 2 Touch [MF].

Touch [MF] again to return the camcorder to autofocus.

#### 3 Touch and hold [▲] or [👤] to adjust the focus.

- The focusing distance displayed will change as you adjust the focus. The focusing distance will be displayed for about 2 seconds. You can change the units used for the distance display with the    [Displayed Units] setting.
- The center of the screen will be magnified to help you focus more easily. You can also turn off this function with the     [Focus Assistance] setting.
- If you wish to focus on faraway subjects such as mountains or fireworks, touch and hold [▲] until the focusing distance changes to ∞.

#### 4 Touch [X] to lock the focus at the selected distance.

During manual focus, [MF] will appear on the screen.

### Touch AF

#### 1 Open the manual focus screen.



#### 2 Touch a subject that appears inside the frame.

- The Touch AF mark () will flash and the camcorder will focus automatically on the subject or spot you touched on the screen.
- Touch [MF] again to return the camcorder to autofocus.
- If necessary, you can further adjust the focus manually (step 3 in the previous procedure).

### 3 Touch [X] to lock the focus at the selected distance.

During manual focus, [MF] will appear on the screen.

#### NOTES

- When you use [] and [] to adjust the focus manually, you can touch inside the frame to automatically focus on that spot.

## White Balance

The white balance function helps you to accurately reproduce colors under different lighting conditions so that white objects will always look truly white in your recordings.

Operating modes:

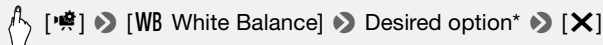

\* When you select [ Custom WB], set the custom white balance with the following procedure before touching [X].

### To set the custom white balance

Point the camcorder at a white object, so it fills the whole screen, and touch [Set WB].

When the adjustment is completed, [] stops flashing and disappears. The camcorder will retain the custom white balance even if you turn it off.

#### Options (♦ Default value)



[ **Automatic**]<sup>♦</sup> The camcorder automatically sets the white balance for natural looking colors.

[ **Daylight**] To record outdoors.

[ **Tungsten**] To record under tungsten and tungsten-type 3-wavelength fluorescent lighting.

[ **Custom WB**] Use the custom white balance setting to make white subjects appear white under colored lighting.

## NOTES

- **When you select the custom white balance:**
  - Set [] to [**32x** Optical].
  - Reset the white balance when you change locations or the lighting or other conditions change.
  - Depending on the light source,  may keep flashing. The result will still be better than with [**AWB** Automatic].
- Custom white balance may provide better results in the following cases:
  - Changing lighting conditions.
  - Close-ups.
  - Subjects in a single color (sky, sea or forest).
  - Under mercury lamps, certain types of fluorescent lights and LED lights.

## Frame Rate

You can change the frame rate (the number of frames recorded per second) to change the look of your movies.

Operating modes:



### Options for AVCHD movies (♦ Default value)

[**60i**]♦ 60 fields per second, interlaced. Standard frame rate of analog NTSC TV signals.

[**PF30**] Shooting at 30 frames per second, progressive\*. Use this frame rate to easily edit your AVCHD movies, for example, to post them on the Web.

\* Recorded as 60i.

### Options for MP4 movies (♦ Default value)

[**30P**]♦ 30 frames per second, progressive.

[**24P**] 24 frames per second, progressive.

## NOTES

- When the video quality is set to [60P Recording] (60P or 35 Mbps), the frame rate is automatically set to 60P and cannot be changed.

## Tele Macro

Using tele macro, the camcorder can focus at a shorter distance (up to 50 cm (1.6 ft.) from the subject at full telephoto), allowing you to get closer shots of small subjects like flowers and insects. This function also adds a soft focus to the background, so the subject not only looks larger but it also stands out more.

Operating modes:



- \* In **AUTO** mode, tele macro will be activated automatically when you zoom in to full telephoto and bring the camcorder up close to the subject.

## POINTS TO CHECK

- When the shooting mode is set to **SCN**, select a Special Scene mode other than [ Fireworks].

### 1 Activate tele macro.

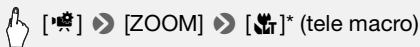

- \* Touch again to turn off the tele macro function.

- The camcorder will automatically adjust the zoom to the telephoto end.



### 2 Touch [●].

- Touch [■] to stop recording.

### 3 Touch [X].



## NOTES

- Any of the following actions will deactivate the tele macro function.
  - Turning off the camcorder.
  - Pressing .
  - Setting the shooting mode to **AUTO** mode,  mode or the [🎆 Fireworks] Special Scene mode in **SCN** mode.
  - Zooming out toward **W** (wide angle).
- Tele macro cannot be turned on/off while recording.

## Audio Scenes

You can have the camcorder optimize the audio settings of the built-in microphone by selecting the audio scene that matches your surroundings. This will greatly enhance the sense of “being there.”

Operating modes:



\* In  mode, the audio scene is always set to [🎵 Standard].

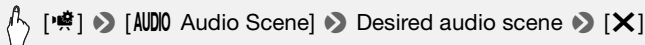

### Options Default value)

[🎵 **Standard**] To record most general situations. The camcorder records with standard settings.

[🎤 **Music**] To vibrantly record music performances and singing indoors.

[👤 **Speech**] Best for recording human voices and dialog.

[🐦 **Forest and Birds**] To record birds and scenes in forests. The camcorder clearly captures sound as it spreads.

[🚫 **Noise Suppression**] To record scenes while reducing noise from wind, passing vehicles and similar ambient sound. Ideal for recording at the beach or in places with a lot of noise.

## Using Headphones

Use headphones for playback or to check the audio level while recording. The headphones are connected to the AV OUT/🎧 terminal, which is used for both the headphones and the audio/video output. Before connecting the headphones, follow the procedure below to change the function of the terminal from AV output to 🎧 (headphones) output. Do not connect the headphones to the AV OUT/🎧 terminal if the 🎧 icon does not appear on the screen. The noise output in such case may be harmful to your hearing.

Operating modes:



### 1 Change the function of the terminal to headphones output.

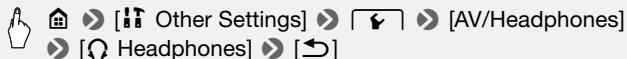

### 2 Connect the headphones to the AV OUT/🎧 terminal.

### 3 Adjust the volume as necessary.

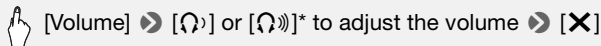

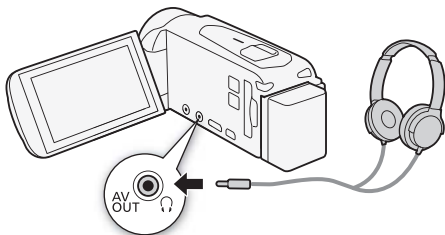

\* You can also drag your finger along the [Headphones] bar.

- 🎧 will appear on the screen.





## To adjust the volume during playback

In  mode, and in  mode during slideshow playback, adjust the headphones volume the same way you adjust the speaker's volume ( 49, 94).

### IMPORTANT

- When using headphones, make sure to lower the volume to an appropriate level.

### NOTES

- Use commercially available headphones with a  $\varnothing$  3.5 mm minijack.
- Even if [AV/Headphones] was set to [ Headphones] in a playback mode, the function of the AV OUT/ terminal will return automatically to AV output when you turn off the camcorder.
- **HF-R52/R50** Audio will not be output from the AV OUT/ terminal while Wi-Fi functions are in use.

---

## Using an External Microphone

When recording in very quiet surroundings, the built-in microphone may pick up the sound of the camcorder's internal machinery. In such case, we recommend using an external microphone.

Operating modes:



---

## Using the WM-V1 Wireless Microphone

Using the optional WM-V1 Wireless Microphone, you can reliably record sound even when recording subjects at a distance exceeding the practical range of the built-in microphone. For details on connecting and using the WM-V1, refer to the instruction manual supplied with the microphone.

## Using Commercially Available Microphones

You can also use commercially available condenser microphones with their own power supply. You can connect almost any stereo microphone with a  $\varnothing$  3.5 mm plug but audio recording levels may vary.

**Connect the external microphone to the MIC terminal.**

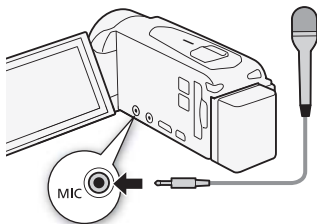

### **i** NOTES

- When you are using a microphone connected to the MIC terminal, the audio level indicator will be displayed automatically.
- When referring to the instruction manual of the WM-V1, note that the procedure written for manually adjusting the audio recording level does not apply to this camcorder. Refer to [*Mic. Level*] (144) for details.



# Advanced Playback and Editing

In this chapter, you can learn how to use functions related to playback and editing, such as capturing video snapshot scenes and photos from your movies and playing back your movies with background music.

## Capturing Video Snapshot Scenes and Photos from a Movie

You can capture video snapshot scenes or photos from a previously recorded scene. For example, you may want to print photos from video recorded at a party or create a small video clip using video snapshot scenes from the highlights of an event.

### Capturing a Video Snapshot Scene

Operating modes:



**1 Play back the scene from which you want to capture the video snapshot scene** (📖 46).

**2 Press** **[START/STOP]** **to capture the video snapshot scene.**

- The camcorder captures the video snapshot scene for about 4 seconds (the blue frame serves as a visual progress bar), and then enters playback pause mode.
- Alternatively, you can touch the screen and then touch **[🎬]** to capture the video snapshot scene.

**3 Touch** **[■]** **to stop the playback.**

The new video snapshot scene will appear at the end of the index screen on the same recording date when the original scene was recorded.

### **i** NOTES

- You can change the length of the video snapshot scenes you capture to 2 or 8 seconds with the **[🎬] > [🎬] > [Video Snapshot Length]** setting.

- A video snapshot scene can be captured only during playback; it cannot be captured during playback pause mode.
- Video snapshot scenes cannot be captured from scenes shorter than 1 second.
- When the source scene is itself a video snapshot scene, you may not be able to capture a video snapshot scene depending on the length of the source scene and the length currently selected for video snapshot scenes.
- When you start capturing a video snapshot scene less than 1 second from the end of the scene, the video snapshot scene will be captured starting from the beginning of the following scene.
- During the playback of video snapshot scenes captured from a previously recorded movie, you may notice some anomalies in the picture/sound at the point where the playback switches to a new scene.

## Capturing Photos

---

Operating modes:



- 1 **Play back the scene from which you want to capture the photo (📖 46).**
- 2 **Pause the playback at the point you want to capture.**
- 3 **Touch [PHOTO].**
- 4 **Touch [■] to stop the playback.**

### NOTES

- The size of captured photos will be 1920x1080.
- The data code of the photos will reflect the date and time of recording of the original scene.
- Photos captured from a scene with a lot of fast movement may be blurred.
- **HF R52/R50** Photos will be recorded on the memory selected for recording photos.

## Playback with Background Music

Canon offers for download 3 music tracks that can be used as background music when playing back your movies or a slideshow of your photos. You can also mix the original audio and the background music and adjust the mix balance to your preference.

Operating modes:



- 1 Open the desired index screen (📖 46).
- 2 Select the music track.

👉 [Home] ➤ [Settings] Other Settings ➤ [Speech Bubble] ➤ [Select Music] ➤ [ON On] ➤ [▲] or [▼] to select the desired music track

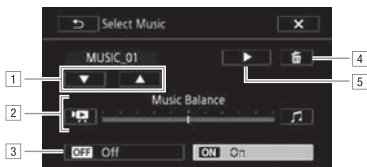

- 1 Select the desired music track.
  - 2 Adjust the background music balance.
  - 3 Play back the original sound (no background music).
  - 4 Delete the music track selected.
  - 5 Listen to the music track selected. Touch again (■) to stop the playback.
- 3 Adjust the mix balance between the original sound and the background music.
- Touch [🗨️] (more of the original sound) or [🎵] (more of the background music) or drag your finger along the [Music Balance] bar to adjust the background music balance as desired.

- 4 Touch [**X**] and then touch a scene to start the playback with the selected background music.

### To adjust the background music balance during playback

- 1 During playback, touch the screen to display the playback controls.
- 2 Touch [], touch [] or [] to adjust the background music balance as desired, and touch [].

### To delete a music track

In the [Select Music] screen, touch [] or [] to select the track you want to delete.



### IMPORTANT

- If you use copyrighted songs and music tracks in your video creations, remember that music under copyright may not be used without permission from the copyright holder, except for cases permitted under applicable laws, such as for personal use. Make sure to follow applicable laws when using music files.

### NOTES

- The music files used for background music are stored in the built-in memory (**HFR52/R50** only). To play back recordings from a memory card with background music, you will need to download the music files in advance ( 192).
- After downloading the music files to your computer, use **Transfer Utility LE** to transfer them to the memory that contains the recordings you want to play back with background music. For details, refer to the 'Transfer Utility LE Software Guide' (PDF file).
- Initializing a memory card will permanently erase any music files you may have transferred to the card. (**HFR52/R50** The music files that come pre-installed in the built-in memory will be restored after it is initialized.)



## Selecting the Playback Starting Point

If you have a very long scene, you may want to start playing back the scene from a certain point. You can use the movie timeline (AVCHD scenes only) to break the scene to segments at fixed time intervals ranging from 6 seconds to 6 minutes.

Operating modes:



- 1 Open the desired index screen for AVCHD movies (📖 46).
- 2 Open the scene's [Timeline] screen.



- The [Timeline] screen appears. The large thumbnail will show the first frame of the scene. Below it, the timeline ruler shows frames taken from the scene at fixed intervals.
- 3 Touch the desired frame in the timeline ruler to start playing back the scene from that point.

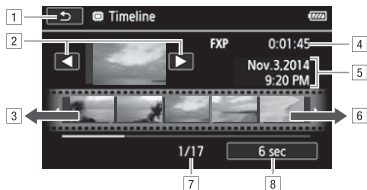

- 1 Touch twice to return to the index screen.
- 2 Previous/next scene.
- 3 Drag your finger left along the ruler to display the next 5 frames.
- 4 Scene's video quality and length.
- 5 Recording date and time.
- 6 Drag your finger right along the ruler to display the previous 5 frames.
- 7 Current scene / Total number of scenes.
- 8 Currently selected interval between frames.

### To change the interval between frames

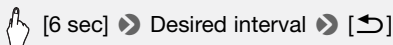

## Dividing Scenes

You can divide AVCHD scenes in order to leave out the best parts and later cut out the rest.

Operating modes:



- 1 Play back the desired scene (📖 46).
- 2 Touch the screen and then touch [⏏] to pause the playback.
- 3 Open the screen for dividing scenes.

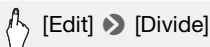

- 4 Bring the scene to a precise point, if necessary.

Playback controls will appear on the screen (📖 48). Use any special playback modes (fast playback, frame reverse/advance) as necessary to locate the desired point.

- 5 Divide the scene.

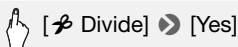

- The video from the division point to the end of the scene will appear as a new scene in the index screen.

### NOTES

- When advancing/reversing frames while dividing the scenes, the interval between frames is about 0.5 seconds.
- If the scene cannot be divided at the point where you paused the playback, advance/reverse a frame and then divide the scene.
- During the playback of a scene that was divided, you may notice some anomalies in the picture/sound at the point where the scene was cut.
- Video snapshot scenes and other scenes that are too short (less than 3 seconds) cannot be divided.
- Scenes cannot be divided within 1 second from the beginning or the end of the scene.

## Trimming Scenes

You can trim MP4 scenes by removing everything up to a certain point or everything after a certain point. By doing so, you leave only memorable moments to keep for posterity.

Operating modes:



- 1 Play back the desired scene (📖 46).
- 2 Touch the screen and then touch [⏸] to pause the playback.
- 3 Open the screen for trimming scenes.

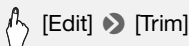

- 4 Bring the scene to a precise point, if necessary.

- The point at which is movie will be trimmed is indicated by the ⏸ marker.
- Playback controls will appear on the screen (📖 48). Use any special playback modes (fast playback, frame reverse/advance) as necessary to locate the desired point.

- 5 Trim the scene.





- You can select whether to trim the part before or after the ⏸ marker and whether to save the remaining part of the video as a new scene (keeping the original scene) or to overwrite the original scene.
- Touch [Stop] to interrupt the operation while it is in progress.

### NOTES



- You may not be able to trim the following types of scenes.
  - **HFR52/R50** Scenes copied from the built-in memory to an SDXC memory card.
  - Scenes recorded or copied onto a memory card using another device.

## Changing the Thumbnail Image of a Scene

For scenes recorded in  mode, you can change the thumbnail image that will appear in the baby album ([] index screen).

Operating modes:



- 1 Open the [] index screen ( 46).
- 2 Play back the desired scene.
- 3 When the image you want to use as the thumbnail image of the scene appears, touch the screen and then touch [] to pause the playback.
- 4 Open the [Set Thumbnail] screen.

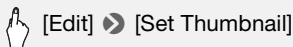

- 5 Bring the scene to a precise point if necessary.

Playback controls will appear on the screen ( 48). Use any special playback modes (fast playback, frame reverse/advance) as necessary to locate the desired point.

- 6 Set the displayed frame as the scene's thumbnail image.

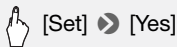

### NOTES

- Only the thumbnail of the scene displayed in the baby album ([] index screen) will change.
- Dividing a scene whose thumbnail image was changed will reset the scene's thumbnail image.

## Photo Slideshow

You can play a slideshow of all the photos and even set it to music.

Operating modes:



- 1 Open the [📷] index screen (📖 50).
- 2 Select the music track.

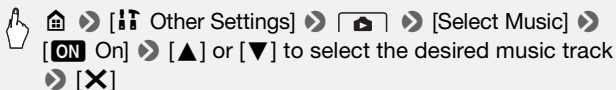

- 3 Touch the photo that will open the slideshow to display it in single photo view.
- 4 Touch the screen to display the playback controls, then touch [▶] to play back the slideshow set to the selected music track.

### During the photo slideshow

- Touch the screen and touch [🔊] or [🔊] to adjust the volume.
- Touch the screen and touch [⏏] to stop the slideshow.

### NOTES

- You can change the transition effect between photos with the  ➤ [📷] ➤ [Slideshow Transition] setting.
- The music files used for background music are stored in the built-in memory (**HFR52/R50** only). To play back with background music a slideshow of photos recorded on a memory card, you will need to download the music files in advance (📖 192).
- After downloading the music files to your computer, use **Transfer Utility LE** to transfer them to the memory that contains the recordings you want to play back with background music. For details, refer to the 'Transfer Utility LE Software Guide' (PDF file).
- Initializing a memory card will permanently erase any music files you may have transferred to the card. (**HFR52/R50** The music files that come pre-installed in the built-in memory will be restored after it is initialized.)

## HFR52/R50 Copying Recordings to a Memory Card

You can copy your recordings from the built-in memory to a memory card.

### POINTS TO CHECK

- Insert the memory card to which you want to copy the recordings into the memory card slot and make sure it has sufficient available space.

## Copying Recordings from the Index Screen

---

Operating modes:



### 1 Open the desired index screen in the built-in memory (46, 50).

To copy all the scenes/photos recorded on a specific date, drag your finger left/right until a scene or photo you want to copy appears.

### 2 Copy the recordings.

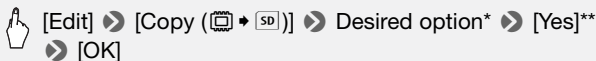



\* When you select [Select], perform the following procedure to select the individual recordings you want to copy before touching [Yes].

\*\*Touch [Stop] to interrupt the operation while it is in progress.

## To select individual recordings

### 1 Touch the individual scenes/photos you want to copy.

- A checkmark ✓ will appear on the recordings you touch. The total number of selected recordings will appear next to the  icon.
- Touch a selected scene or photo to remove the checkmark. To remove all checkmarks at once, touch [Remove All]  [Yes].

### 2 After selecting all the desired recordings, touch [OK].

## Options

**[date/folder name]** Copy all the scenes/photos recorded on a particular date. For AVCHD movies, the date will appear in the control button. For MP4 movies and photos, the folder name\* (153) will appear.

**[Select]** Select individual recordings to copy.

**[All Scenes]** Copy all the scenes.

**[All Photos]** Copy all the photos.

\* The last four digits of the folder name indicate the date the folder was created.

## Copying a Single Photo

---

Operating modes:



- 1 In single photo view, select the photo you want to copy.
- 2 Touch the screen to display the playback controls.
- 3 Copy the photo.



- 4 Drag your finger left/right to select another photo to copy or touch [X].

### ! IMPORTANT

- Observe the following precautions while the ACCESS indicator is on or flashing. Failing to do so may result in permanent data loss.
  - Do not open the memory card slot cover.
  - Do not disconnect the power source or turn off the camcorder.
  - Do not change the camcorder's operating mode.



## NOTES

- In the following cases, you will not be able to copy recordings to the memory card:
  - If the memory card slot cover is open.
  - If the LOCK switch on the memory card is set to prevent writing.
  - If the file numbering is at maximum ( 153).
  - If there is no memory card in the memory card slot.



## External Connections

This chapter explains how to connect your camcorder to an external device such as a TV, VCR, or computer.

**HFR52/R50** You can also use the camcorder's convenient Wi-Fi functions (📖 117).

### Terminals on the Camcorder

Open the LCD panel to access the terminals on the camcorder.

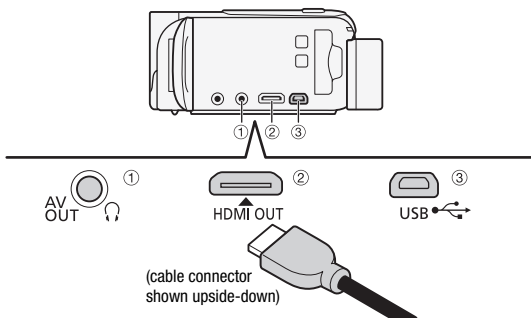

- ① AV OUT/🔊 Terminal
- ② HDMI OUT Terminal\*

The HDMI OUT terminal offers a high-quality digital connection that combines audio and video in a single convenient cable. This terminal is an HDMI mini receptacle. When using a commercially available HDMI cable, make sure the HDMI cable is Type A to Type C.

- ③ USB Terminal

This terminal is a mini-AB receptacle. You can use the supplied USB cable to connect to a computer or other digital devices with standard-A receptacles; or use the optional UA-100 USB Adapter to connect to the camcorder an external hard drive or similar storage device with a standard-A cable (**HFR52/R50** only).

\* When connecting the supplied High Speed HDMI cable to the camcorder, make sure to align the triangle marks on the cable's connector and on the camcorder's terminal.

## Connection Diagrams

In the following connection diagrams, the left side shows the terminals on the camcorder and the right side shows (for reference only) an example of terminals on a connected device.

### Connection 1

HDMI

**Type: Digital • Quality: High definition • Output only**

Connect to a high-definition TV (HDTV) with an HDMI input terminal.

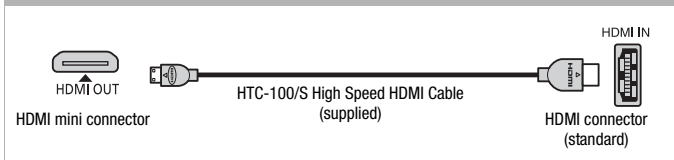

### About the HDMI™ connection

The HDMI (High-Definition Multimedia Interface) connection (1) is a convenient all-digital connection using a single cable for both video and audio. When you connect the camcorder to an HDTV equipped with an HDMI terminal, you can enjoy video and audio playback at the highest quality.

- The HDMI OUT terminal on the camcorder is for output only. Do not connect it to an HDMI output terminal on an external device, as this may damage the camcorder.
- While the camcorder is connected to an HDTV using connection 1, there will be no video output from the AV OUT/Ⓜ terminal.
- Correct operation cannot be guaranteed when connecting the camcorder to DVI monitors.
- Depending on the HDTV, correct playback of personal video content may not be possible using connection 1. Try using connection 2.

**Type: Analog • Quality: Standard definition • Output only**

Connect to a standard TV or a VCR with audio/video input terminals. Change the following settings on the camcorder:

- [ ] ➤ [ ] ➤ [ ] ➤ [TV Type] according to the TV set (widescreen or 4:3), if the TV cannot automatically detect and change the aspect ratio
- [ ] ➤ [ ] ➤ [AV/Headphones] to [AV AV]

**Type: Digital data connection**

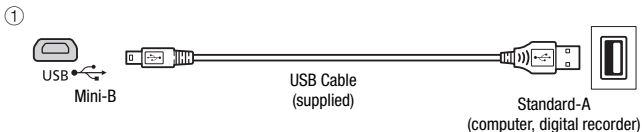

Connect to a computer to save your recordings, to a compatible digital video recorder to copy your recordings, or to an external hard drive to easily save a perfect copy of an entire memory (**HFR52/R50** only).

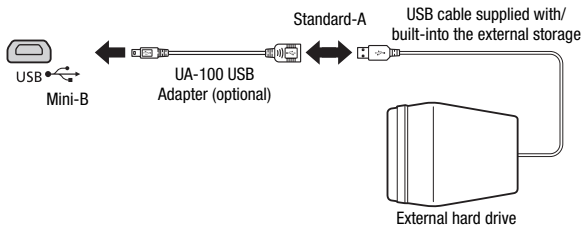

② **HFR52/R50** only



## NOTES

- Power the camcorder using the compact power adapter and only then connect it to the computer using the supplied USB cable in the following cases.
  - To write back scenes recorded with this camcorder that were previously saved on a computer. For details, refer to the 'Transfer Utility LE Software Guide' (PDF file).
  - To transfer music files to a memory card in the camcorder in order to use them as background music. For details, refer to the 'Transfer Utility LE Software Guide' (PDF file).
  - To save your recordings on a computer.
  - To save a memory onto an external hard drive (**HFR52/R50** only).
- Sound from the built-in speaker will be muted while a cable is connected to the HDMI OUT terminal or AV OUT/ terminal.
- **HFR52/R50** Audio and video will not be output from the HDMI OUT terminal or AV OUT/ terminal while Wi-Fi functions are in use.

## Playback on a TV Screen

Connect the camcorder to a TV to enjoy your recordings with family and friends. Playback on an HDTV using the HDMI OUT terminal will ensure the best playback quality.

Operating modes:





**1 Turn off the camcorder and the TV.**

**2 Connect the camcorder to the TV.**

Refer to *Connection Diagrams* ( 99) and select the most appropriate connection for your TV.

**3 Turn on the connected TV.**

On the TV, select as the video input the same terminal to which you connected the camcorder. Refer to the instruction manual of the connected TV.

**4 Turn on the camcorder and set it to  or  mode.**

Play back the desired movies or photos.

## NOTES

- We recommend powering the camcorder using the compact power adapter.
- Connection [2](#): When you play back your 16:9 movies on standard TV sets with a 4:3 aspect ratio, the TV set will switch automatically to wide-screen mode if it is compatible with the Video ID-1 system. Otherwise, change the aspect ratio of the TV manually.
- You can also play your AVCHD movies directly from your memory card on AVCHD-compatible HDTVs and digital recorders with a card slot **compatible with the type of memory card used\***.

\* Refer to the instruction manual of the device. Depending on the device used, correct playback may not be possible even if the device is AVCHD-compatible. In such case, play back the recordings on the memory card using the camcorder.

# Saving and Sharing Your Recordings

## HFR52/R50 Converting Movies to MP4 Format

You can convert AVCHD movies into MP4 movies or even convert MP4 movies into smaller MP4 movies. This is convenient, for example, when you want to upload the MP4 movies to the Web.

The movie you want to convert must be in the built-in memory. After the conversion, the resulting MP4 movie will be saved on the memory card.

Operating modes:



- 1 Open the desired index screen in the built-in memory (📖 46).
- 2 Open the screen for selecting scenes to convert.

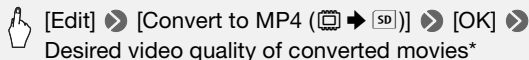

\* Before selecting the video quality, touch [Join Scenes] to join the converted movies into one movie.

- 3 Touch the individual scenes you want to convert.
  - A checkmark ✓ will appear on the scenes you touch. The total number of selected scenes will appear next to the  icon.
  - Touch a selected scene to remove the checkmark. To remove all checkmarks at once, touch [Remove All] ➤ [Yes].
- 4 After selecting all the desired scenes, touch [OK] and then touch [Next].
  - To add a cinema-look filter\* (📖 61): Touch [FILTER 1] and then select the desired filter. Touch the button again to deactivate the filter.
  - To add decorations\* (📖 65): Touch [].
  - To adjust the volume (📖 49) or background music balance (📖 87): Touch [].

\* When a cinema-look filter is applied to a movie, you cannot add decorations.
- 5 Touch [START] to convert the scene.

Touch [STOP] to interrupt the operation while it is in progress.

## 6 Touch [OK].

### NOTES

- When you convert movies, the video quality you can choose for the resulting MP4 movie will depend on the video quality of the original movie. Based on the following options, movies in the built-in memory will be converted and then copied to the memory card.

#### AVCHD movies

| Video quality and resolution of the original scene (📺) | Video quality and resolution of the converted scene (📺) |                     |                   |
|--------------------------------------------------------|---------------------------------------------------------|---------------------|-------------------|
|                                                        | 24 Mbps (1920x1080)                                     | 17 Mbps (1920x1080) | 4 Mbps (1280x720) |
| 60P (1920x1080)                                        | –                                                       | –                   | –                 |
| MXP (1920x1080)                                        | ●                                                       | ●                   | ●                 |
| FXP (1920x1080)                                        | ●                                                       | ●                   | ●                 |
| LP (1280x720)                                          | ●                                                       | ●                   | ●                 |

#### MP4 movies

| Video quality and resolution of the original scene (📺) | Video quality and resolution of the converted scene (📺) |                     |                   |
|--------------------------------------------------------|---------------------------------------------------------|---------------------|-------------------|
|                                                        | 24 Mbps (1920x1080)                                     | 17 Mbps (1920x1080) | 4 Mbps (1280x720) |
| 35 Mbps (1920x1080)                                    | –                                                       | –                   | –                 |
| 24 Mbps (1920x1080)                                    | ●                                                       | ●                   | ●                 |
| 17 Mbps (1920x1080)                                    | ●                                                       | ●                   | ●                 |
| 4 Mbps (1280x720)                                      | –                                                       | –                   | ●                 |

- If you convert AVCHD movies with a frame rate of 60i, the frame rate of the resulting MP4 movie will be 30P.



## Saving Recordings on a Computer

Recordings made with this camcorder are saved in the built-in memory (HFR52/R50 only) or on a memory card. Because space is limited, make sure to save your recordings on a computer on a regular basis.

This section explains how to save your recordings on a computer using a USB connection. Use **Transfer Utility LE\*** for AVCHD movies and **ImageBrowser EX\*\*** for MP4 movies.

**HFR52/R50** Refer to *Wi-Fi Functions* (📖 117) for details on saving your recordings wirelessly.

\* Software for AVCHD movies, available for free from PIXELA's Web site.

\*\* Software for photos and MP4 movies, available for free from your local Canon Web site.

### Saving AVCHD Movies (Windows only)

---

With **Transfer Utility LE**, you can save to your computer the scenes you have recorded. Download the software and install it before you connect the camcorder to the computer for the first time. An Internet connection is required to download the software. Perform the following procedures while referring to the supplied 'Transfer Utility LE Startup Guide'.



#### POINTS TO CHECK

- Before installing the software, make sure your computer is connected to the Internet.

### Installation

---

#### 1 Download the zip file from PIXELA's Web site.

Visit PIXELA's Web site to download the software's zip file.

[http://pixela.jp/cetule\\_dl/](http://pixela.jp/cetule_dl/)

#### 2 Uncompress the zip file.

The zip file contains the installer (setup.exe) and the Software Guide (PDF file).

#### 3 Run the installer to install the software.

For details, refer to 'Transfer Utility LE Software Guide' (PDF file).

## Connecting the Camcorder to a Computer

---

Operating modes:



### 1 Power the camcorder using the compact power adapter.

If the camcorder is connected to the computer while it is powered only by the battery pack, previously saved video files cannot be transferred back to the camcorder and music files cannot be transferred to a memory card in the camcorder.

### 2 Camcorder: Open the desired index screen for AVCHD movies (📖 46).

### 3 Connect the camcorder to the computer using the supplied USB cable.

Connection [3]-①. Refer to *Connection Diagrams* (📖 100).

### 4 Camcorder: Select [All (for PC only)].

Camcorder: When the connection is successfully established, [USB Connection] appears on the screen.

### 5 Computer: Click the icon shown on the right to open the software Transfer Utility LE.



### 6 Use Transfer Utility LE to save your AVCHD movies.

For details about using the software, refer to the 'Transfer Utility LE Software Guide' (PDF file).

## Saving MP4 Movies and Photos (Windows/Mac OS)

---

With **ImageBrowser EX** you can save MP4 movies and photos to your computer and easily organize them. Download the software and install it before you connect the camcorder to the computer for the first time. An Internet connection is required to download the software. Refer to the 'ImageBrowser EX User Guide' (PDF file) for the full system requirements and other information.



### POINTS TO CHECK

- Before installing the software, make sure your computer is connected to the Internet.

## Installation

---

Make sure to install the software even if you have a different version of **ImageBrowser EX** on your computer. The auto-update function of the software may make available to you features optimized for this cam-corder.

The 'ImageBrowser EX User Guide' will also be installed with the software.

### 1 Download the software from your local Canon Web site.

Visit the following Web site, click on your country/region and follow the onscreen instructions to download **ImageBrowser EX**.

<http://www.canon.com/icpd>

### 2 Install ImageBrowser EX.

For details about opening the software package and running the installer, refer to the instructions on the download Web site.

### 3 Follow the onscreen instructions to select your area (continent), country/region and language.

Available options will vary depending on your country/region.

### 4 In the main installer panel, click [Easy Installation].

For Windows users, if a User Account Control dialog box appears, follow the instructions.

### 5 Follow the onscreen instructions to complete the installation.

- During the installation process, you may be prompted to install Microsoft Silverlight. Follow the instructions to do so.
- **CameraWindow** will also be installed.

### To check that the software was installed correctly

You can check that the software was installed correctly by looking for the ImageBrowser EX icon in the following location.



**Windows:** The shortcut will be added to the Desktop screen.

**Mac OS:** In the Dock.

If you cannot find the icon, check your Internet connection and install the software again.

## First-time connection to a computer running Windows

The first time you connect the camcorder to the computer, you also need to select the **CameraWindow** auto-launch setting.

### Connecting the Camcorder to a Computer

---

Operating modes:



- 1 Power the camcorder using the compact power adapter.
- 2 Open the [**?**] index screen for MP4 movies (📖 46) or [**📷**] index screen (📖 50).
- 3 Connect the camcorder to the computer using the supplied USB cable.
  - Connection [3]-①. Refer to *Connection Diagrams* (📖 100).
  - Camcorder: When the connection is successfully established, [USB Connection] appears on the screen.
- 4 **Computer: Start CameraWindow and save your MP4 movies and photos.**
  - On Windows computers after having activated the auto-launch setting and on Mac OS computers, **CameraWindow** will start automatically and the main screen will appear.
  - Refer to *Non-EOS DIGITAL Cameras: Importing Images with CameraWindow* in the 'ImageBrowser EX User Guide'. This PDF file can be accessed through the ? menu on the upper right of the **ImageBrowser EX** main screen.

## IMPORTANT

- **When the camcorder is connected to a computer:**
  - Do not open the memory card slot cover and do not remove the memory card.
  - Do not access, change or delete any of the camcorder's folders or files directly from the computer as this may result in permanent data loss. When saving recordings on a computer, we recommend using **Transfer Utility LE** for AVCHD movies and **ImageBrowser EX** for MP4 movies and photos.
- Observe the following precautions while the ACCESS indicator is on or flashing. Failing to do so may result in permanent data loss.
  - Do not open the memory card slot cover.
  - Do not disconnect the USB cable.
  - Do not turn off the camcorder or the computer.
  - Do not change the camcorder's operating mode.
- If you wish to use the recordings on your computer, make copies of them first. Use the copied files, retaining the originals.

## NOTES

- Depending on the computer, the software may not work correctly or you may not be able to play back movies.
- The following types of MP4 scenes will be recognized as multiple files on other devices.
  - Scenes exceeding 4 GB.
  - Scenes recorded at 35 Mbps exceeding 30 minutes.
  - Scenes recorded at a video quality other than 35 Mbps exceeding 1 hour.
- Regardless of the charge conditions of the battery pack in the camcorder, Battery Capacity on the camcorder's details area of **Camera-Window's** main screen will always appear as 'Full'.
- **Users of Windows XP and later versions, or Mac OS X:** Your camcorder is equipped with the standard Picture Transfer Protocol (PTP) allowing you to transfer photos (JPEG only) simply by connecting the camcorder to a computer using the supplied USB cable, without having to install **ImageBrowser EX**.

## HF R52/R50 Memory Save: Saving an Entire Memory onto an External Hard Drive





You can easily save all the movies and photos you recorded onto a commercially available external hard drive connected directly to the camcorder. You can also use the camcorder to play back your recordings directly from the hard drive.

Initialize the hard drive (📖 113) when you use it with this camcorder for the first time.

Operating modes:



### Saving a Memory onto an External Hard Drive

- 1 Power the camcorder using the compact power adapter.
- 2 Press  to set the camcorder to playback mode.
- 3 Connect the camcorder to the external hard drive.
  - If the USB cable supplied with the external hard drive has a standard-A connector, you will need to use the optional UA-100 USB Adapter.
  - Connection -. Refer to *Connection Diagrams* ( 100).
- 4 Save the entire contents of the desired memory.

 [Save to Hard Drive] ➤ Desired memory ➤ [Yes]\*  
➤ [OK]

- \* Touch [Stop] ➤ [Yes] to interrupt the operation while it is in progress.
- After selecting the memory, you can check the name of the folder that will be created on the hard drive. Every memory save operation will create a separate memory save folder with the date (in numerical form) used as the folder name.

## Before disconnecting the external hard drive

Before turning off or physically disconnecting the external hard drive, be sure to safely end the connection to the camcorder to avoid damage to your files. From the [External Hard Drive] screen:



[Safely Remove Hard Drive] ► [Yes]

### IMPORTANT





- Make sure you power the camcorder with the compact power adapter before you save a memory to the external hard drive. If the compact power adapter becomes disconnected, the connection between the camcorder and the hard drive will end, which may lead to the corruption of data in the hard drive.
- Observe the following precautions while the ACCESS indicator is on or flashing. Failing to do so may result in permanent data loss.
  - Do not open the memory card slot cover.
  - Do not disconnect the USB cable.

### NOTES

- You cannot select both the built-in memory and memory card to save them simultaneously.
- If you performed multiple memory save operations on the same day (for example, if you saved the built-in memory and then a memory card), the folder name of memory save folders following the first one will end in a numerical suffix (for example, "-1", "-2").
- Up to 10 memory save folders can be created for any given date and up to 300 memory save folders can be saved on a single hard drive.
- If the external hard drive is partitioned, only the first partition will be recognized.
- You cannot use the following types of external hard drives. For the latest information on devices that can be used, please visit your local Canon Web site.
  - USB-powered portable hard drives.
  - Hard drives with a capacity over 2 TB.
  - USB flash drives or media connected to card readers.

## Playing Back Previously Saved Recordings from the External Hard Drive

---

- 1 Power the camcorder using the compact power adapter.
- 2 Press  to set the camcorder to playback mode.
- 3 Connect the camcorder to the external hard drive.
  - If the USB cable supplied with the external hard drive has a standard-A connector, you will need to use the optional UA-100 USB Adapter.
  - Connection -. Refer to *Connection Diagrams* ( 100).
- 4 Touch [Play Back from Hard Drive] and select the memory save folder you wish to play back.









The index screen will appear.
- 5 Touch a recording to play it back.

To switch to another memory save folder, touch  and then select the memory save folder you wish to play back. Repeat step 5.
- 6 When you have finished playing back, be sure to safely end the connection to the external hard drive before physically disconnecting it.

     [Safely Remove Hard Drive]  [Yes]

### To delete the memory save folder currently displayed

- 1 Delete the memory save folder.

    [Other Settings]    [Delete Memory Save Folder]  [Yes]  [OK]

- 2 Safely end the connection to the external hard drive before physically disconnecting it.



## IMPORTANT

- Be careful when deleting recordings. Once deleted, recordings cannot be recovered.
- Observe the following precautions while the external hard drive's access indicator is on or flashing.
  - Do not disconnect the USB cable.
  - Do not disconnect the camcorder or the external hard drive.
  - Do not change the camcorder's operating mode.

### Initializing the External Hard Drive



---

#### 1 Power the camcorder using the compact power adapter.

Do not disconnect the power source or turn off the camcorder until the initialization is completed.

#### 2 Press to set the camcorder to playback mode.

#### 3 Connect the camcorder to the external hard drive.

- If the USB cable supplied with the external hard drive has a standard-A connector, you will need to use the optional UA-100 USB Adapter.
- Connection  3-②. Refer to *Connection Diagrams* ( 100).

#### 4 Initialize the external hard drive.

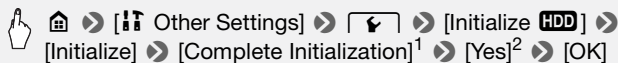

<sup>1</sup> Touch this option if you want to physically erase all the data rather than just clear the file allocation table of the hard drive. For large-capacity hard drives this operation can take several hours.

<sup>2</sup> If you selected the [Complete Initialization] option, you can touch [Cancel]  [OK] to cancel the initialization while it is in progress. All recordings will be erased and the hard drive can be used without any problem.

#### 5 Safely end the connection to the external hard drive before physically disconnecting it.

## IMPORTANT

- Initializing the external hard drive will permanently erase all the data on the hard drive (including your recordings, previous data not saved with the camcorder, and partitioned drives). Make sure to copy in advance important data to a computer or other device.

## Copying Recordings to an External Video Recorder

### In High Definition

Operating modes:



Connect the camcorder to Blu-ray Disc recorders and other AVCHD-compatible digital video recorders using the supplied USB cable to make perfect copies of your movies in high definition. If the external digital video recorder has an SD memory card slot\*, you can use the memory card to copy your movies without connecting the camcorder.

\* Make sure the external device is compatible with the type of memory card used.

### Connecting

- 1 Power the camcorder using the compact power adapter.
- 2 Open the desired index screen ( 46).
- 3 Connect the camcorder to the digital video recorder using the supplied USB cable.

Connection -. Refer to *Connection Diagrams* ( 100).

- 4 **HFR52/R50** Camcorder: Select the memory that contains the scenes you want to copy.
  - Select an option other than [All (for PC only)].
  - When the connection is successfully established, [USB Connection] appears on the screen.

### Recording

Details will vary depending on the device used so be sure to refer to the instruction manual of the digital video recorder.

## In Standard Definition

---

You can copy your movies by connecting the camcorder to a VCR or a digital video recorder with analog audio/video inputs. Video output will be in standard definition, although the original scenes are in high definition.

Operating modes:



## Connecting

---

Connect the camcorder to the VCR using Connection 2. Refer to *Connection Diagrams* (100).

## Recording

---

- 1 Power the camcorder using the compact power adapter.
- 2 Open the [P] index screen that contains the scenes you wish to copy (46).  
Verify that [AV/Headphones] is set to [AV AV].
- 3 **External recorder:** Load a blank cassette or disc and set the recorder to record pause mode.
- 4 **Camcorder:** Locate the scene you wish to copy and pause the playback shortly just before the desired scene.
- 5 **Camcorder:** Resume playback.  
By default, the date and time will be embedded in the output video signal. You can change this using the [Display Date/Time] setting.
- 6 **External recorder:** Start recording when the scene you wish to copy appears; stop recording when it ends.
- 7 **Camcorder:** Stop playback.

## NOTES

- Use an external Blu-Ray Disc recorder compliant with AVCHD ver. 2.0 specifications to copy onto Blu-Ray discs movies recorded in 60P or MXP mode.

---

## Uploading MP4 Movies and Photos to the Web

With **ImageBrowser EX**, you can also upload your MP4 movies to YouTube and photos to Facebook from your computer. Additionally, you can use **CANON iMAGE GATEWAY\*** to make photo albums and more.

\* This service may not be available in all countries/regions.

### Installation

Install the software before you connect the camcorder to the computer for the first time. The software is compatible with computers running Windows or Mac OS operating systems. Refer to *Saving MP4 Movies and Photos (Windows/Mac OS)* ( 106).

### Connecting to the Computer and Uploading Your Recordings

---

Refer to the relevant sections in the 'ImageBrowser EX User Guide' (PDF file). This PDF file can be accessed through the ? menu on the upper right of the **ImageBrowser EX** main screen.



## HF-R52/R50 Wi-Fi Functions

This chapter contains information about how to operate the Wi-Fi functions of your camcorder, including the Wi-Fi network setup needed to add your camcorder to an existing Wi-Fi network.

### The Camcorder's Wi-Fi Functions

You can use the camcorder's Wi-Fi functions to connect wirelessly to Wi-Fi enabled devices\* like smartphones or tablets and save, play back and upload your recordings. Refer to *Glossary* (📖 140) for a definition of some of the frequently used terms in this text.

\* "iOS device" is used in this text to refer to Wi-Fi-enabled iPhones and iPads, while "Android device" refers to Wi-Fi-enabled Android smartphones and tablets.

#### iOS Devices

---

- Install the CameraAccess plus app and use your iPhone or iPad as a remote control to record with the camcorder (📖 120). You can even stream video from the camcorder and record it directly on your iOS device.
- Installing the Movie Uploader app, you can save recordings on your iOS device and even upload them to YouTube or Facebook (📖 126).
- Use a Web browser to access the camcorder and play back recordings on your iOS device (📖 125).



Movie Uploader



CameraAccess plus

#### Android Devices

---

- Install the CameraAccess plus app and use your smartphone or tablet as a remote control to record with the camcorder (📖 120). You can even stream video from the camcorder and record it directly on your Android device.

- Use a Web browser to access the camcorder and play back recordings on your Android device. You can also save a local copy on your Android device (📖 125).



CameraAccess plus

## Computers and Other Wi-Fi Devices

---

- On computers with a Wi-Fi receiver, use a Web browser to access the camcorder and play back recordings on the device. You can also save a local copy on the computer (📖 125).
- Connect the camcorder to an access point as a media server and play back your recordings on computers and other devices connected to the same home network (📖 132).



---

## CANON iMAGE GATEWAY

- Connecting the camcorder to an access point (home network) connected to the Internet, you can also share recordings on CANON iMAGE GATEWAY and enjoy a number of Web services, including uploading recordings to Facebook and YouTube (📖 128).



## Before Using Wi-Fi Functions

Based on the function, the camcorder will connect wirelessly to a Wi-Fi-enabled device, such as a smartphone, directly or to a Wi-Fi network via an access point (wireless router)\*. After selecting the function you want to use, follow the onscreen directions to connect the camcorder.

\* Depending on the manufacturer, the access point may be referred to using a different name, such as wireless LAN router or wireless network router.

## About the camcorder's Wi-Fi standard

The camcorder's Wi-Fi standard complies with the IEEE 802.11 b/g/n protocol and operates in the 2.4 GHz band. As such, the maximum data transfer rate is 11 Mbps for IEEE 802.11b, 54 Mbps for IEEE 802.11g, and 150 Mbps for IEEE 802.11n. Note that these are theoretical values and actual data transfer rates may differ.

### ! IMPORTANT

- Using an unprotected Wi-Fi network can expose your files and data to monitoring by unauthorized third parties. Be aware of the risks involved.

### i NOTES

- When using the camcorder's Wi-Fi functions, do not cover the back portion of the camcorder with your hand or other object. The Wi-Fi antenna is located in the back portion and covering it may interfere with wireless signals.
- Do not open the memory card slot cover during the wireless connection.
- While using Wi-Fi functions, the camcorder's automatic power off function will be disabled.
- Make sure the optional WM-V1 Wireless Microphone is not attached to the camcorder. Wi-Fi functions are not available when the microphone is attached.

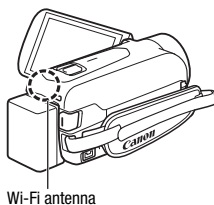

## Using an iOS or Android Device as a Remote Control

Using the CameraAccess plus app\*, you can view the image streamed from the camcorder on your iOS/Android device even when the camcorder is somewhere else. You can use your iOS/Android device as a remote control to start recording on the camcorder and, while using the Monitor from Home function, you can even record the streamed image locally on your iOS/Android device.

\* The CameraAccess plus app, provided by PIXELA, is available for free from the App Store (for iOS devices) and Google Play™ (for Android smartphones).

Operating modes:



### POINTS TO CHECK

- Before you perform the following procedures for the first time, download and install the CameraAccess plus app on your iOS/Android device.

The app can be downloaded for free from the following Web sites.

App Store:

<http://appstore.com/cameraaccessplus>

Google Play™:

<http://play.google.com/store/apps/details?id=jp.co.pixela.cameraaccessplus>

## Streaming via Wi-Fi (Monitor from Home)

With this function, you can monitor the image streamed from the camcorder when it is in another location within Wi-Fi connection range, for example, in another room in the house. You can use your iOS/Android device to control the camcorder and record the streamed image on the camcorder or directly onto your device.

- 1 **Camcorder: Activate the [Monitor from Home] function.**



Home ▶ [Remote Control+Streaming] ▶  
[Monitor from Home] ▶ [OK]

- The camcorder's SSID (network name) and password will appear.
- The camcorder will be ready to connect with the iOS/Android device.



**2 iOS/Android device: In the Wi-Fi settings screen, turn on Wi-Fi and select the network name that appears on the camcorder's screen (step 1). If necessary, enter the password that appears on the camcorder's screen.**

- The camcorder's network name (SSID) should appear in the list of networks/access points detected by the device.
- As long as you do not reset the camcorder's Wi-Fi password, you only need to enter the password the first time you connect the device.
- When the Wi-Fi connection is correctly established, [Connected] will appear on the camcorder's screen.

**3 iOS/Android device: Start the CameraAccess plus app.**

Use the app's onscreen controls to operate the camcorder while viewing the live image on the device.

### **When you have finished recording**

**1 Camcorder: Touch [End] to end the wireless connection and turn off the camcorder.**

**2 iOS/Android device: Close the CameraAccess plus app.**

### **Streaming via Wi-Fi and Internet (Monitor while Out)**

---

With this function, you can leave the camcorder home and monitor the streamed image while you are away. You can even use your iOS/Android device to start recording on the camcorder.

Using the Remote Monitoring Checker utility program (for Windows only), you can check whether your home network's access point and Internet connection meet the requirements for using the Monitor while Out function\*. For details about this program and links to the download page, visit PIXELA's Web site.

<http://pixela.jp/cermc>

\* To use the Monitor while Out Function, an access point compatible with UPnP (Universal Plug and Play) and an Internet connection that can acquire global IP addresses are required.

### 1 Activate the [Monitor while Out] function.

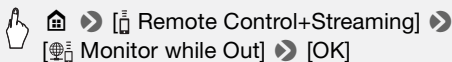

- The first time you activate the function, you will need to set a password and the port to be used by this function (steps 2-4). If you have already completed the settings for the Monitor while Out function, skip to step 5.

### 2 Touch [OK] to open the settings screen.

### 3 To enter the [Password] field, touch [Not configured]. Enter a unique password for the Monitor while Out function and touch [OK].

- The password must be between 4 and 8 characters long. We recommend using an 8-character password using a mix of numbers and uppercase/lowercase letters.
- To enter the password (and the port number in the next step) use the virtual keyboard (📖 124).

### 4 To change the port number to be used, touch [80]. Enter a different port number and touch [OK].

By default, the port number is set to 80 but you can change it if necessary.

### 5 If necessary, set up a connection to an access point.

- If you have previously configured and saved a connection to an access point, the camcorder will connect automatically to the last access point used. Continue to step 6.
- If no connections to access points have been saved in the camcorder, the message [Save the access point] will appear on the screen. Touch [OK] to configure and save a new access point connection (step 2 in *Wi-Fi Connection Using an Access Point* (📖 134)) before continuing with this procedure.

### 6 When the wireless connection is successfully established, the camcorder's ID will be displayed on the screen.

The camcorder will be ready to connect with the iOS/Android device.

## Connecting the iOS/Android Device

---

If the iOS/Android device is connected to the same Wi-Fi network as the camcorder, CameraAccess plus will recognize the camcorder's ID and register it automatically. Otherwise, you can enter the camcorder's ID manually.

As long as you do not reset the camcorder's settings, you only need to register the camcorder's ID the first time you connect the device. Later on, you only need to enter the Monitor while Out password (start this procedure from step 4).

### To register the camcorder's ID in the CameraAccess plus app

- 1 If the iOS/Android device is near the camcorder, turn on Wi-Fi and select the same access point as that to which the camcorder is connected (step 5 in the previous procedure).**
- 2 Start the CameraAccess plus app and touch Setting and then Start.**

If the iOS device is not connected to the same access point as the camcorder, enter manually the camcorder's ID that is displayed on the camcorder's screen (step 6 in the previous procedure).
- 3 Touch Finish and close the CameraAccess plus app.**

If necessary, disconnect the iOS/Android device from the access point.

### To use the Monitor while Out function

- 4 While you are out, start the CameraAccess plus app.**

Make sure the iOS/Android device is connected to a Wi-Fi access point.
- 5 Touch Start under Monitor while Out.**
- 6 Enter the password for the Monitor while Out function that you set in the camcorder (step 3 of the previous procedure) and then touch Connect.**

Use the app's onscreen controls to operate the camcorder while viewing the live image on the device.

### To end the Monitor while Out mode

On the camcorder, touch [End] to end the wireless connection and then turn off the camcorder.

## Using the virtual keyboard

When you need to enter text for various settings, touch the text field and a virtual keyboard will appear on the screen. The illustration below explains the various keys you can use.



- 1 Switch between letters and numbers/special characters.
- 2 Change the position of the cursor.
- 3 Delete the character to the cursor's left (backspace).
- 4 Caps Lock. When the numerical keyboard is displayed, [#%?] switches between set 1 and set 2 of special characters.

## **i** NOTES

- For details about the CameraAccess plus app, visit PIXELA's Web site. <http://pixela.jp/cecap>
- This function is not available in the following cases.
  - When the video quality is 60P.
  - When dual recording or relay recording is activated.
- Depending on the connection and the strength of the wireless signal, there may be interruptions in the live video image or the response may be slow.
- If you mount the camcorder on the optional CT-V1 Camera Pan Table, you can use the CameraAccess plus app on your iOS/Android device as a remote control to move the camcorder sideways (panning) in addition to starting/stopping recording. For details, refer to the instruction manual of the CT-V1.

## Remote Browse: Viewing Recordings Using a Web Browser on an iOS or Android Device

With the Remote Browse function, you can use the Web browser on any device equipped with a Wi-Fi receiver (iOS/Android devices, computers, etc.) to access the camcorder. You can then play back your recordings using the Web browser and even save local copies of them on your device\*.

\* Depending on the device, OS, browser, movie format and video quality, you may not be able to play back or download recordings. For details, visit your local Canon Web site.

Operating modes:





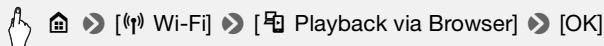

- 1 Camcorder:** From any movie index screen, activate the Remote Browse mode.



- The camcorder's SSID (network name) and password will appear.
  - The camcorder will be ready to connect with the wireless device.
- 2 iOS/Android device:** In the Wi-Fi settings screen, turn on Wi-Fi and select the network name that appears on the camcorder's screen (step 1). If necessary, enter the password that appears on the camcorder's screen.
    - The camcorder's network name (SSID) should appear in the list of networks/access points detected by the device.
    - As long as you do not reset the camcorder's Wi-Fi password, you only need to enter the password the first time you connect the device.
  - 3 iOS/Android device:** Start the Web browser.
  - 4 iOS/Android device:** Enter the URL that appears on the camcorder's screen into the Web browser's address bar.
    - When the Wi-Fi connection is correctly established, the Playback via Browser screen will appear.

- The URL is always the same so you may find it convenient to bookmark the URL.

## 5 iOS/Android device: Select the desired recording from the index screen and play it back.

- Touch the button on the top left of the screen to change the index screen displayed. Touch **AVCHD** (AVCHD movies), **MP4** (MP4 movies) or  (photos) of the desired memory ( built-in memory or  SD memory card).
- Touch a thumbnail to display the photo (or the first frame of a movie). MP4 movies only: Touch again to play back the movie.
- AVCHD movies cannot be played back.
- Touch  to return to the index screen.
- Devices other than iOS devices: Touch  to save a local copy of the movie/photo on the device.

## When you have finished

Camcorder: Touch [End]  [OK] to end the wireless connection and turn off the camcorder.

## NOTES

- The following types of MP4 scenes will be recognized as multiple files on other devices.
  - Scenes exceeding 4 GB.
  - Scenes recorded at 35 Mbps exceeding 30 minutes.
  - Scenes recorded at a video quality other than 35 Mbps exceeding 1 hour.

## Saving Recordings and Uploading Movies to the Web Using an iOS Device

Using the Movie Uploader app\*, you can play back and save\*\* your movies and photos on an iOS device. You can also upload your movies to YouTube and Facebook even when you are away from your home network.

\* The Movie Uploader app, provided by PIXELA, is available for free from the App Store.

\*\*Not available for MP4 movies recorded at 35 Mbps.

## Operating modes:



### POINTS TO CHECK

- Before you perform this procedure for the first time, install the Movie Uploader app on your iOS device. The app can be downloaded for free from the following Web site.  
<http://appstore.com/movieuploader>

#### **1 Camcorder: From any index screen, set the camcorder to connect with the iOS device.**



- The camcorder's SSID (network name) and password will appear.
  - The camcorder will be ready to connect with the iOS device.
- #### **2 iOS device: In the Wi-Fi settings screen, turn on Wi-Fi and select the network name that appears on the camcorder's screen (step 1). If necessary, enter the password that appears on the camcorder's screen.**
- The camcorder's network name (SSID) should appear in the list of networks/access points detected by the device.
  - As long as you do not reset the camcorder's Wi-Fi password, you only need to enter the password the first time you connect the device.
  - When the Wi-Fi connection is correctly established, [Connected] will appear on the camcorder's screen.
- #### **3 iOS device: Use the Movie Uploader app to upload the camcorder's movies.**
- You can also play back or save movies and photos on the iOS device.
  - Only movies can be uploaded to YouTube.

### **When you have finished**

Camcorder: Touch [End] ➤ [OK] to end the wireless connection and turn off the camcorder.

## NOTES

- Depending on factors such as the wireless network conditions, it can take some time to upload video files.
- The procedure above may differ depending on the version of iOS you are using.
- For details about the Movie Uploader app, visit PIXELA's Web site.  
<http://www.pixela.co.jp/oem/canon/e/movieuploader/>
- The following types of MP4 scenes will be recognized as multiple files on other devices.
  - Scenes exceeding 4 GB.
  - Scenes recorded at 35 Mbps exceeding 30 minutes.
  - Scenes recorded at a video quality other than 35 Mbps exceeding 1 hour.

## Sharing Recordings with CANON iMAGE GATEWAY

After you register for CANON iMAGE GATEWAY\*, you will be able to access various Web services\*\*. You will be able to upload movies and photos to online albums, share links to the online albums on Twitter, upload movies to Facebook and YouTube, send links to your online albums by e-mail to friends and family, and more! To use this function, you will need an access point connected to the Internet.

\* Availability differs from area to area.

\*\* "Web services" is used in this text to refer to various Internet services supported by CANON iMAGE GATEWAY.

### CANON iMAGE GATEWAY

CANON iMAGE GATEWAY is a Web site that provides various photo-related services for owners of qualified Canon products. After you complete the free registration online, you can use the Web services, create online photo albums, and more. Visit Canon's Web site for information on registration and countries/regions where you can use this service.

<http://canon.com/cig>





## General requirements

- Computer with **ImageBrowser EX** and **CameraWindow** correctly installed. For details on installing the software, refer to *Saving MP4 Movies and Photos (Windows/Mac OS)* (📖 106).
- Completed free registration online for CANON iIMAGE GATEWAY.
- Account settings for the services you plan to use (YouTube, Facebook, etc.). Available services may differ by country/region.

## Setting the Desired Web Services in the Camcorder

---

Using **CameraWindow**, log in to CANON iIMAGE GATEWAY and set the Web services you want to use. Refer to 'CameraWindow User Guide' for details on using the software. This PDF file can be accessed through the ? menu on the upper right of the **ImageBrowser EX** main screen.

Operating modes:



- 1 **Camcorder:** Open the [🗨️] index screen for MP4 movies (📖 46) or [📷] index screen (📖 50).
- 2 **Connect the camcorder to the computer using the supplied USB cable.**  
Connection [3]-1. Refer to *Connection Diagrams* (📖 100).
- 3 **Computer: Start CameraWindow.**
  - Windows: If the AutoPlay dialog box appears, click Downloads Images From Canon Camera to open the main screen.
  - On Windows computers after having activated the auto-launch setting and on Mac OS computers, **CameraWindow** will start automatically and the main screen will appear.
- 4 **Computer: Click Camera Settings > Set Up Web Services.**
- 5 **Computer: Log in to CANON iIMAGE GATEWAY and complete the setup process.**
  - Follow the onscreen instructions to register the services you want to use. You will need the account information (user name, password, etc.) to register some services.
  - CANON iIMAGE GATEWAY and all other selected Web services will be set in the camcorder and the **CameraWindow** menu screen will appear.

## 6 Computer: Exit CameraWindow and then end the connection between the camcorder and computer.

### NOTES

- Available Web services differ depending on the country/region of use and may be updated from time to time. For the latest details about available services and terms of use, visit your local CANON iIMAGE GATEWAY Web site.
- If the date set in the camcorder is not correct, the camcorder cannot connect to CANON iIMAGE GATEWAY. Make sure the date is correct before trying to establish a connection.
- Once you have set the maximum number of Web services in the camcorder, you will not be able to set any additional services. Delete unnecessary Web services and then set the desired Web service.
- You cannot set multiple accounts for Web services other than e-mail.
- CANON iIMAGE GATEWAY, Facebook, Twitter and e-mail notifications are available only for MP4 movies and photos when you use CameraWindow.

## Sharing Your Recordings Using Web Services

---

Conveniently share your recordings with family and friends using Web services.

Operating modes:



- 1 From any index screen, set the camcorder to connect with the Web service.



- If you have previously configured and saved a connection to an access point, the camcorder will connect automatically to the last access point used.
- If no connections to access points have been saved in the camcorder, the message [Save the access point] will appear on the screen. Touch [OK] to configure and save a new access point connection (step 2 in *Wi-Fi Connection Using an Access Point* (133)) before continuing with this procedure.

- When the wireless connection is successfully established, the [To Web Service] screen will appear on the camcorder's screen.

## 2 Select the desired Web service.

When you select  (e-mail), the list of registered e-mail addresses will appear. Select the e-mail addresses to which you want to send an e-mail notification.

## 3 Touch the type of upload (AVCHD movie, MP4 movie or photo) and the memory on which the desired recordings are saved.

## 4 Touch the scene or photo(s) to upload.

- When uploading photos, you can touch up to 10 photos to upload at a time. When you have finished selecting, touch [OK].  
Touch a selected photo to remove it from the selection. To cancel the selection, touch [Remove All]  [Yes].
- If you are uploading to YouTube, read the YouTube agreement carefully and touch [I Agree] if you agree.
- The upload will begin automatically.
- You can touch [Stop] to cancel the wireless transfer while it is in progress.

## 5 Touch [OK].

### Checking your uploads using CANON iIMAGE GATEWAY Library

You can check the movies and photos you have uploaded to CANON iIMAGE GATEWAY on the Library screen and on the various online albums. On the Library screen, you can also check what files you have sent and the various settings for the Web services. For details on CANON iIMAGE GATEWAY, refer to the Help module (in the upper right of the screen).

### NOTES

- For movies, you can upload one at a time; for photos, up to 10 at a time. The maximum size and length of movies you can upload will vary depending on the Web service used.
- Depending on the access point's (wireless router's) settings and capabilities, it can take some time to upload files.

- E-mail addresses must consist of single-byte characters. Only e-mail addresses with 16 or fewer characters before the @ mark can be set in the camcorder.

## Wireless Playback on a Computer

Using the Media Server function, you can wirelessly view your movies and photos on your computer or similar device. You will need an access point connected to your home network and software installed on your computer that can play back movies and photos from a media server. We recommend that you connect the computer to the access point using a LAN cable. Refer also to the instruction manuals for the computer, software and access point.

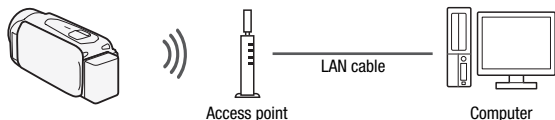

Operating modes:



- 1 **Camcorder:** From any index screen, activate the media server function.



- If you have previously configured and saved a connection to an access point, the camcorder will connect automatically to the last access point used.
- If no connections to access points have been saved in the camcorder, the message [Save the access point] will appear on the screen. Touch [OK] to configure and save a new access point connection (step 2 in *Wi-Fi Connection Using an Access Point* (📖 133)) before continuing with this procedure.

- 2 Camcorder: When the wireless connection is successfully established, [Connected] will appear on the camcorder's screen.**  
You can touch [View Information] to view the access point's SSID, connection protocol, and the camcorder's IP address and MAC address. From the information screen, you can also touch [Change Connection Point] to connect to a different access point.
- 3 Computer: Start your preferred media player software and select your camcorder's model name from the list of media servers.**  
On standalone media players and other devices, connect the device to the home network and select your camcorder's model name from the list of media servers.
- 4 Computer: Select the folder for the camcorder's built-in memory or memory card and play back the movies and photos.**
- 5 Camcorder: Touch [End] ➤ [OK] when finished.**

### NOTES

- Depending on the access point's (wireless router's) settings and capabilities, playback may take time to start or may not appear smooth. For details, refer to *Troubleshooting* (📖 164).

## Wi-Fi Connection Using an Access Point

The camcorder can connect to a Wi-Fi network using a wireless router (access point) and even remember the settings for the 4 most recently used access points.

### General requirements











- Correctly configured router that complies with the 802.11b/g/n protocol and is Wi-Fi certified (bears the logo shown on the right) and a home network.



Operating modes:



- Open the [(📶) Network Setup] screen.

   [ Remote Control+Streaming] (recording mode) or  
[ Wi-Fi] (video playback mode, from any index screen)  
 [ Check/Edit Settings]  [OK]   
[Access Point Connection Settings]  [Not configured]

## 2 Touch the desired setup method.

Depending on the setup method chosen, the procedure will be different. Read the descriptions below and continue with the procedure described in the relevant page.

### Options

**[WPS: Button]\*** Simply press and hold the WPS button on your wireless router and then touch the camcorder's screen. This is the easiest connection method if you are using a WPS-compatible router. Continue the procedure as described in *Wi-Fi Protected Setup (WPS)* ( 135).

**[WPS: PIN Code]\*** Access the access point's configuration screen using your Web browser. The camcorder will give you a PIN code, which you will enter into the browser. You will need a WPS-compatible router and a computer or other device connected to it. Continue the procedure as described in *Wi-Fi Protected Setup (WPS)* ( 135).

**[Search for Access Points]** Following the camcorder's onscreen instructions, you select the desired access point from a list and then enter your password. Continue the procedure as described in *Searching for Access Points* ( 136).

**[Manual Setup]** You manually enter the access point's name, password and other network settings. This method is recommended only for advanced users of Wi-Fi networks. Continue the procedure as described in *Manual Setup* ( 136).

\* WPS, which stands for Wi-Fi Protected Setup, is a standard that makes connecting to a wireless router easier.

## Wi-Fi Protected Setup (WPS)

If your access point is WPS-compatible (bears the logo shown on the right), connecting the camcorder to it can be very easy. If you cannot successfully connect the camcorder using WPS, try using the [Search for Access Points] method. Refer also to the access point's (wireless router's) instruction manual.



### 1 [WPS: Button] method

Press and hold the WPS button on the wireless router.

- Depending on the router, the amount of time required may differ.
- Make sure the router's WPS function is activated.

### [WPS: PIN Code] method

From a computer or similar device connected to the access point, use the Web browser to open the router's WPS settings screen. After the 8-digit PIN code appears on the camcorder's screen, enter it into your router's WPS settings screen.

### 2 Within 2 minutes, touch [OK] on the camcorder's screen.

- The camcorder will connect to the access point.
- You can touch [Stop] and then [OK] to interrupt the Wi-Fi Protected Setup while it is in progress.
- When the Wi-Fi Protected Setup is finished, [Configuration completed] will appear on the screen.

### 3 Touch [OK] to save the configuration.

- If you were in the process of performing another procedure, the camcorder will automatically connect to the access point. Return to the procedure of the function you were previously using:  
Step 6 in *Streaming via Wi-Fi and Internet (Monitor while Out)* (📖 122); Step 2 in *Sharing Your Recordings Using Web Services* (📖 130); Step 2 in *Wireless Playback on a Computer* (📖 132).
- Otherwise, touch [↩] ➡ [X] to close the menu.

## Searching for Access Points

---

After you touch [Search for Access Points], the camcorder will take a few seconds to detect access points available in the vicinity and will display the first one. Make a note in advance of the network name (SSID) and password (encryption key) of the access point you want to use. (This will usually be the wireless router on your home network.) To enter text for the various settings, use the virtual keyboard (📖 124).

### 1 Select the desired access point.

- If the desired access point is not displayed, you can touch [▲] or [▼] to go through the list of detected access points. You can also touch [Search Again] to have the camcorder search for access points again.
- When the network name (SSID) of the desired access point appears, touch [OK].

### 2 To enter the [Encryption Key] field, touch [Not configured]. Enter the access point's password (encryption key) and touch [OK].

If the access point selected in step 1 did not have a [🔒] icon, this step is not necessary.

### 3 Touch [OK] to save the configuration.

- If you were in the process of performing another procedure, the camcorder will automatically connect to the access point. Return to the procedure of the function you were previously using: Step 6 in *Streaming via Wi-Fi and Internet (Monitor while Out)* (📖 122); Step 2 in *Sharing Your Recordings Using Web Services* (📖 130); Step 2 in *Wireless Playback on a Computer* (📖 132).
- Otherwise, touch [↩] ➤ [X] to close the menu.

## Manual Setup

---

Perform this procedure to manually configure the wireless connection settings. This may be necessary, for example, if your access point's network name (SSID) cannot be detected due to the stealth function being enabled. Manual setup is for advanced users of Wi-Fi networks. To enter text for the various settings, use the virtual keyboard (📖 124).

### 1 In the [SSID] field, enter the SSID (network name). Touch [OK] and then touch [Next].



- 2 In the [Authentication/Encryption Method] field, touch [OPEN NONE] and then touch the desired method.  
If you selected [OPEN WEP], the WEP index is 1.
- 3 In the [Encryption Key] field, enter the encryption key (password). Touch [OK] and then touch [Next].  
If you selected [OPEN NONE] in step 2, this step is not necessary.
- 4 Touch [Automatic] or [Manual] to select how to obtain the IP address.  
If you selected [Automatic], proceed to step 9.
- 5 To enter the [IP Address] field, touch [0.0.0.0]. Touch the first field and touch [▲]/[▼] to change the value. Change the rest of the fields in the same way and touch [OK].
- 6 Enter the [Subnet Mask] field in the same way and touch [Next].
- 7 Enter the [Default Gateway] field in the same way and touch [Next].
- 8 Enter the [Primary DNS Server] and [Secondary DNS Server] fields in the same way and touch [Next].
- 9 Touch [OK] to save the configuration.
  - If you were in the process of performing another procedure, the camcorder will automatically connect to the access point. Return to the procedure of the function you were previously using:  
Step 6 in *Streaming via Wi-Fi and Internet (Monitor while Out)* (📖 122); Step 2 in *Sharing Your Recordings Using Web Services* (📖 130); Step 2 in *Wireless Playback on a Computer* (📖 132).
  - Otherwise, touch [↩] ➤ [X] to close the menu.

## NOTES

- The Wi-Fi functions available and the setup method will vary depending on the specifications and characteristics of the Wi-Fi network you want to use.

## Viewing and Changing Wi-Fi Settings

You can review and change, if necessary, the settings used for the various Wi-Fi connections and for the Monitor while Out function.

Operating modes:



1 Open the [Check Current Configuration] screen.

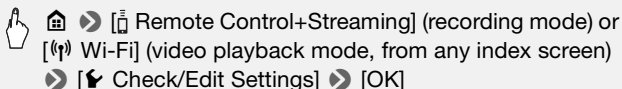

**To view the connection settings for iOS/Android devices**

2 Touch [Smartphone Connection Settings].

The camcorder's SSID and password will appear.

3 If necessary, change the camcorder's network name (SSID) and password.



- The next time you make a wireless connection, you will need to change the Wi-Fi settings on the iOS/Android device.

4 Touch [] repeatedly to return to the (Home) menu, and then touch [] to close the menu.

**To view the access point's connection settings**

2 Touch [Access Point Connection Settings].

- The 4 access points' SSID settings in the camcorder's memory will appear.
- If there are available connection slots, you can touch [Not configured] to set up a new access point ( 133).

3 Touch the SSID of the access point whose settings you want to view.

- The access point's settings will appear.

- Touch [▲] and [▼] to view more information.
  - To delete the access point connection displayed, touch [Edit] ➤ [Delete] ➤ [Yes].
  - To manually change the settings of the access point connection displayed, touch [Edit] ➤ [Manual Setup] and then perform the procedure in *Manual Setup* (📖 136).
  - Touch [↶] to return to the access point selection screen.
- 4 Touch [↶] repeatedly to return to the 🏠 (Home) menu, and then touch [✕] to close the menu.

### **To view the settings for the Monitor while Out function (recording mode only)**

#### **2 Touch [Monitor while Out Settings].**

The password and port to be used for the Monitor while Out function will appear.

#### **3 If necessary, change the settings.**

Steps 3 and 4 in *Streaming via Wi-Fi and Internet (Monitor while Out)* (📖 122).

- 4 Touch [↶] repeatedly to return to the 🏠 (Home) menu, and then touch [✕] to close the menu.

## **Glossary**

This is a glossary of some of the basic terms used frequently in this chapter. The documentation for your access point may also contain a glossary you can refer to.

### **Access Point**

A wireless access point (WAP) is a device that allows wireless devices, like your camcorder, to connect to a wired network (including to the Internet) using the Wi-Fi standard. In most cases, this will be your wireless router.

### **IP Address**

Exclusive number assigned to each device connected to the network.

### **SSID**

Service Set Identifier. This is simply the public name of a Wi-Fi network.

### **WPS**

Wi-Fi Protected Setup. Standard for easy and secure setup of Wi-Fi networks created by the Wi-Fi Alliance.























## Additional Information

This chapter contains troubleshooting advice, screen messages, handling and maintenance tips, and other information.















### Appendix: Menu Options Lists



The functions that are available depend on the camcorder's operating mode. On the camcorder's screen, menu items not available appear grayed out. For details about how to select an item, refer to *Using the Menus* (📖 32). For details about each function, see the reference page or the explanations following the tables. Underlined menu options indicate default values.

#### (Home) Menu

| Menu item                                                                                                     | Setting options                                                                                                                                                                                                                                                                                                                                                                                                                                                                                                                                  |  |
|---------------------------------------------------------------------------------------------------------------|--------------------------------------------------------------------------------------------------------------------------------------------------------------------------------------------------------------------------------------------------------------------------------------------------------------------------------------------------------------------------------------------------------------------------------------------------------------------------------------------------------------------------------------------------|-----------------------------------------------------------------------------------|
| [  Other Settings]           | Opens the respective menus.                                                                                                                                                                                                                                                                                                                                                                                                                                                                                                                      | 35,<br>146                                                                        |
| [  Recording Setup]          | Opens the respective menu.                                                                                                                                                                                                                                                                                                                                                                                                                                                                                                                       | 142                                                                               |
| [Shooting Mode]                                                                                               | [  Baby], [ <u>AUTO</u> Auto], [  Cinema],<br>[SCN Scene], [ <u>P</u> Programmed AE]                                                                                                                                                                                                                                                                                           | 59                                                                                |
| [  Main Functions]           | Opens the respective menu.                                                                                                                                                                                                                                                                                                                                                                                                                                                                                                                       | 142                                                                               |
| [  Remote Control+Streaming] | [  Monitor from Home], [  Monitor while Out],<br>[  Check/Edit Settings]                                                                                                                                                                                                                     | 120,<br>138                                                                       |
| [  Photo Playback]         | Opens the respective index screen.                                                                                                                                                                                                                                                                                                                                                                                                                                                                                                               | 50                                                                                |
| [  Movie Playback]         | Opens the respective index screen.                                                                                                                                                                                                                                                                                                                                                                                                                                                                                                               | 46                                                                                |
| [  Baby Album]             | Opens the respective index screen.                                                                                                                                                                                                                                                                                                                                                                                                                                                                                                               |                                                                                   |
| [  Video Snapshot]         | Opens the respective index screen.                                                                                                                                                                                                                                                                                                                                                                                                                                                                                                               |                                                                                   |
| [(  ) Wi-Fi]               | [  Movie Uploader], [  Playback via Browser],<br>[  To Web Service], [  Media Server],<br>[  Check/Edit Settings] | 117                                                                               |



















## [ Recording Setup] Menu











| Menu item                                                                                                            | Setting options                                                                                                                                                                                                                                                                                                                                                                                                                                  |  |
|----------------------------------------------------------------------------------------------------------------------|--------------------------------------------------------------------------------------------------------------------------------------------------------------------------------------------------------------------------------------------------------------------------------------------------------------------------------------------------------------------------------------------------------------------------------------------------|-----------------------------------------------------------------------------------|
| [Movie Format]                                                                                                       | [  AVCHD], [  MP4]                                                                                                                                                                                                                                                             | 56                                                                                |
| [Video Quality]                                                                                                      | When [Movie Format] is set to [  AVCHD]:<br>[60P 60P Recording], [MPX High Quality],<br>[FXP Standard (Full HD)], [LP Long Play]<br>When [Movie Format] is set to [  MP4]:<br>[35Mbps 60P Recording], [24Mbps High Quality],<br>[17Mbps Standard (Full HD)], [4Mbps Long Play] | 56                                                                                |
| [  HFR52/R50] [Recording Media]      | [Rec Media for Movies] [  Built-in Memory],<br>[  Memory Card]                                                                                                                                                                                                                 | 58                                                                                |
|                                                                                                                      | [Rec Media for Photos] [  Built-in Memory],<br>[  Memory Card]                                                                                                                                                                                                                 |                                                                                   |
| [  HFR52/R50] [Dual/Relay Recording] | [  Standard Recording], [  Dual Recording],<br>[  Relay Recording]*                                                                                                                           | 58                                                                                |

\* The icon shown ( or ) depends on the current selection for [Recording Media].

## [ Main Functions] and [Edit] Panels

### [ Main Functions] Panel - Recording Modes

| Control button                                                                                    | Setting options/Function                                                                                                                                                                                                                                                                                                                                                                                                                                                                                                                                                                                                                                                                                                                                             |  |
|---------------------------------------------------------------------------------------------------|----------------------------------------------------------------------------------------------------------------------------------------------------------------------------------------------------------------------------------------------------------------------------------------------------------------------------------------------------------------------------------------------------------------------------------------------------------------------------------------------------------------------------------------------------------------------------------------------------------------------------------------------------------------------------------------------------------------------------------------------------------------------|-----------------------------------------------------------------------------------|
| [  Video Snapshot] | [ON], [OFF]                                                                                                                                                                                                                                                                                                                                                                                                                                                                                                                                                                                                                                                                                                                                                          | 71                                                                                |
| [AUDIO Audio Scene]                                                                               | [  Standard], [  Music], [  Speech],<br>[  Forest and Birds], [  Noise Suppression]                                                                                                                                                                                                                                                   | 81                                                                                |
| [  Decoration]   | [  Pens and Stamps], [  Animated Stamps],<br>[  Date/Time] or [  ] (Baby mode stamps),<br>[  ] (image mix), [  ] (pause live video),<br>[  ] (minimize toolbar) | 65                                                                                |
| [ZOOM]                                                                                            | Zoom controls, [  ]/[  ] control,<br>[  ] (tele macro): Toggle on or <u>off</u>                                                                                                                                                                                                                                                                                                                                                                                                                             | 44,<br>80                                                                         |





| Control button                                                                                  | Setting options/Function                                                                                                                                                                                                                                                                                                 |  |
|-------------------------------------------------------------------------------------------------|--------------------------------------------------------------------------------------------------------------------------------------------------------------------------------------------------------------------------------------------------------------------------------------------------------------------------|---------------------------------------------------------------------------------|
|  Faders]        | [ <b>OFF</b> Off], [ <b>F1</b> Fade Trigger], [ <b>F2</b> Wipe]<br>[Black Screen], [White Screen]                                                                                                                                                                                                                        | 74                                                                              |
| [Zoom Type]                                                                                     | [ <b>32x</b> Optical], [ <b>57x</b> Advanced], [ <b>1140x</b> Digital]                                                                                                                                                                                                                                                   | –                                                                               |
| [  Powered IS] | [ON], [ <b>OFF</b> ]                                                                                                                                                                                                                                                                                                     | –                                                                               |
| [  Pre REC]    | [ON], [ <b>OFF</b> ]                                                                                                                                                                                                                                                                                                     | –                                                                               |
| [  Focus]      | [ <b>MF</b> ] (manual focus): Toggle on or <u>off</u> ,<br>Touch AF frame                                                                                                                                                                                                                                                | 76                                                                              |
| [  Exposure]   | [ <b>M</b> ] (manual exposure): Toggle on or <u>off</u> ,<br>Touch AE frame                                                                                                                                                                                                                                              | 75                                                                              |
| [  Mic. Level] | [ <b>A</b> ] (automatic), [ <b>M</b> ] (manual)<br>[Audio Level Indicator]: Toggle on or <u>off</u>                                                                                                                                                                                                                      | –                                                                               |
| [WB White Balance]                                                                              | [ <b>AWB</b> Automatic], [  Daylight], [  Tungsten],<br>[  Custom WB] | 78                                                                              |

**[Zoom Type]:** The camcorder offers three types of zoom.



[**32x** Optical]: For optical zoom, the camcorder uses the optical magnification ratio of the lens.

[**57x** Advanced]: With advanced zoom the maximum magnification ratio is 57x. At full wide angle, the angle of view with advanced zoom is wider than the angle of view with optical zoom.

[**1140x** Digital]: With digital zoom (light blue area on the zoom bar), the image is processed digitally so image quality will deteriorate the more you zoom in.

- This function is available only when the shooting mode is set to ,  or .
- When the shooting mode is set to  or , [Zoom Type] will automatically be set to [**32x** Optical].

**[ Powered IS]:** With Powered IS you can make the image stabilization even more powerful. Powered IS is most effective for shooting faraway non-moving subjects from a stationary position.

- This function is available only when the shooting mode is set to ,  or .



**[📷 Pre REC]:** When this function is activated, the camcorder automatically starts recording 3 seconds before you press **[START/STOP]** so you do not miss important shooting opportunities.

- When the shooting mode is set to , **[📷 Pre REC]** will automatically be set to [ON] and pre-recording cannot be deactivated.
- The camcorder will not record the full 3 seconds prior to pressing **[START/STOP]** if the button was pressed within 3 seconds of having turned on pre-recording or having finished the previous recording.
- Any of the following actions will deactivate the pre-recording function.
  - Leaving the camcorder without any operation for 5 minutes.
  - Changing the operating mode.
  - Activating video snapshot.
  - Touching the **[WB White Balance]** or **[🎛️ Faders]** control button in the **[📷 Main Functions]** panel.
  - Changing the shooting mode.

**[🔊 Mic. Level]:** You can adjust the audio recording level of the built-in or an external microphone.







**[📷]** ➤ **[🔊 Mic. Level]** ➤ **[M] (manual)** ➤ **[◀]/[▶]** to adjust the audio level ➤ **[X]**



- Touch **[A]** to return to automatic audio level adjustment. Touch [Audio Level Indicator] to display the audio level indicator during automatic audio level adjustment.
- Adjust the audio recording level so the audio level meter goes to the right of the -12 dB mark (yellow area) only occasionally.
- When you are using a microphone connected to the MIC terminal, including the WM-V1 Wireless Microphone, the audio level indicator will be displayed automatically.
- When the audio level meter reaches the red point (0 dB), the sound may be distorted.
- We recommend using headphones ( 82) to check the sound level while adjusting the audio recording level.
- This function is available only when the shooting mode is set to , **[SCN]** or **[P]**.



## [Edit] Panel - Mode













| Control button                                                                                                                                                                                                                                 | Index screen                                     | Playback pause |  |
|------------------------------------------------------------------------------------------------------------------------------------------------------------------------------------------------------------------------------------------------|--------------------------------------------------|----------------|-----------------------------------------------------------------------------------|
| <b>HFR52/R50</b><br>From the built-in memory:<br>[Copy (  →  )]              | <date/folder name>,<br>[Select],<br>[All Scenes] | –              | 95                                                                                |
| <b>HFR52/R50</b><br>From the built-in memory:<br>[Convert to MP4<br>(  →  )] | [Select]                                         | –              | 103                                                                               |
| [Delete]                                                                                                                                                                                                                                       | <date/folder name>,<br>[Select],<br>[All Scenes] | [This Scene]   | 53                                                                                |
| [Divide]                                                                                                                                                                                                                                       | –                                                | ●              | 91                                                                                |
| [Trim]                                                                                                                                                                                                                                         | –                                                | ●              | 92                                                                                |

## [Edit] Panel - Mode

| Control button                                                                                                                                                                                                                    | Index screen                                  | Single photo view |  |
|-----------------------------------------------------------------------------------------------------------------------------------------------------------------------------------------------------------------------------------|-----------------------------------------------|-------------------|-----------------------------------------------------------------------------------|
| <b>HFR52/R50</b><br>From the built-in memory:<br>[Copy (  →  )] | <date/folder name>,<br>[Select], [All Photos] | ●                 | 95                                                                                |
| [Delete]                                                                                                                                                                                                                          |                                               | ●                 | 53                                                                                |

## Other Settings] Menus

### Camera Setup (recording mode only)

| Menu item                   | Setting options                                                                                                                                                                                                                                                                                                                                                                                                                                                                                                                                                                                                                                                                                                                                                        |  |
|-----------------------------|------------------------------------------------------------------------------------------------------------------------------------------------------------------------------------------------------------------------------------------------------------------------------------------------------------------------------------------------------------------------------------------------------------------------------------------------------------------------------------------------------------------------------------------------------------------------------------------------------------------------------------------------------------------------------------------------------------------------------------------------------------------------|-----------------------------------------------------------------------------------|
| [Self Timer]                | [ <b>ON</b> On  , [ <b>OFF</b> Off]                                                                                                                                                                                                                                                                                                                                                                                                                                                                                                                                                                                                                                                   | –                                                                                 |
| [Zoom Speed]                | [ <b>VAR</b> Variable], [  Speed 3],<br>[  Speed 2], [  Speed 1]                                                                                                                                                                                                                                                                                                                                                                                                                                                    | –                                                                                 |
| [Zoom Position at Startup]  | [Full Wide Angle], [Last Used Position]                                                                                                                                                                                                                                                                                                                                                                                                                                                                                                                                                                                                                                                                                                                                | –                                                                                 |
| [Focus Assistance]          | [ <b>ON</b> On], [ <b>OFF</b> Off]                                                                                                                                                                                                                                                                                                                                                                                                                                                                                                                                                                                                                                                                                                                                     | –                                                                                 |
| [Face Detection & Tracking] | [ <b>ON</b> On  , [ <b>OFF</b> Off]                                                                                                                                                                                                                                                                                                                                                                                                                                                                                                                                                                                                                                                   | 72                                                                                |
| [Auto Backlight Correction] | [ <b>ON</b> On], [ <b>OFF</b> Off]                                                                                                                                                                                                                                                                                                                                                                                                                                                                                                                                                                                                                                                                                                                                     | –                                                                                 |
| [Auto Slow Shutter]         | [ <b>ON</b> On], [ <b>OFF</b> Off]                                                                                                                                                                                                                                                                                                                                                                                                                                                                                                                                                                                                                                                                                                                                     | –                                                                                 |
| [Flicker Reduction]         | [ <b>OFF</b> Off], [ <b>50Hz</b> 50 Hz], [ <b>60Hz</b> 60 Hz]                                                                                                                                                                                                                                                                                                                                                                                                                                                                                                                                                                                                                                                                                                          | –                                                                                 |
| [Image Stabilizer]          | [  Dynamic], [  Standard], [ <b>OFF</b> Off]                                                                                                                                                                                                                                                                                                                                                                                                                                                                                                                                                         | –                                                                                 |
| [Intelligent IS]            | [  With  , [  Without  <p><b>[Self Timer]:</b> You can have the camcorder start recording after a 10-second countdown. After setting [Self Timer] to [<b>ON</b> On , press <b>[START/STOP]</b> to start the countdown and record video or touch <b>[PHOTO]</b> to start the countdown and take a photo.</p> |                                                                                   |

- This function is not available when the shooting mode is set to .
- Once the countdown has begun, any of the following actions will cancel the self timer.
  - Pressing **[START/STOP]**, when recording movies.
  - Touching **[PHOTO]**, when recording photos.
  - Turning off the camcorder.
  - Changing the camcorder's operating mode.

**[Zoom Speed]:** Determines the zoom speed of the zoom lever.

**[VAR Variable]:** The zoom lever operates at a variable speed. Press gently for a slow zoom; press harder for faster zooms.

**[> Speed 1] to [▶▶▶ Speed 3]:** The zoom lever operates at a constant speed. Speed 1 is the slowest and speed 3 the fastest.

**[Zoom Position at Startup]:** Allows you to choose the position of the zoom when you turn on the camcorder.

**[Full Wide Angle]:** The zoom position will be at full wide angle.







**[Last Used Position]:** The zoom position will be at the same position it was the last time you used zoom.

- When this function is set to [Full Wide Angle] and you manually adjust the focus, the focus will be lost and autofocus will be activated the next time you turn on the camcorder.

**[Focus Assistance]:** When focus assistance is activated, the image at the center of the screen is magnified to help you focus manually (76).

- Using focus assistance will not affect the recordings. It will be cancelled automatically after 4 seconds or when you start recording.
- This function is available only when the shooting mode is set to , **[SCN]** or **[P]**.
- This function is available only for recording movies.



**[Auto Backlight Correction]:** When this setting is set to **[ON On]**, the camcorder automatically corrects for backlight conditions when shooting subjects with a strong light source behind them.

- This function is available only when the shooting mode is set to , **[SCN]** or **[P]**.
- Automatic backlight correction is not available in the following cases.
  - In  mode, when using a cinema-look filter other than [Cinema Standard].
  - In **[SCN]** mode, when using the [ Night Scene], [ Snow], [ Beach], [ Sunset] or [ Spotlight] Special Scene mode.



**[Auto Slow Shutter]:** The camcorder automatically uses slow shutter speeds to obtain brighter recordings in places with insufficient lighting.

- Minimum shutter speed used: 1/30; 1/12 when the frame rate is set to 24P; 1/15 when it is set to PF30 or 30P.
- This function is not available when the shooting mode is set to **[SCN]**.
- If a trailing afterimage appears, set the slow shutter to **[OFF Off]**.

**[Flicker Reduction]:** If the screen starts to flicker when recording movies under fluorescent lights, change the setting to reduce the effect.





- This function is available only when the shooting mode is set to  or .

**[Image Stabilizer]:** The image stabilizer reduces camcorder blur (blur due to the camcorder moving). Select the image stabilization mode according to the shooting conditions.





 **Dynamic]:** Compensates for a higher degree of camcorder shake, such as when shooting while walking, and is more effective as the zoom approaches full wide angle. Available only when [Zoom Type] is set to  Optical].

 **Standard]:** Compensates for a lower degree of camcorder shake, such as when shooting while remaining stationary, and is suitable for shooting natural-looking scenes.

**[OFF Off]:** Use this setting when the camcorder is mounted on a tripod.







- This function is available only when the shooting mode is set to ,  or .
- If the degree of camcorder shake is too high, the image stabilizer may not be able to fully compensate.
- You can activate the Powered IS function ( 143) when more powerful image stabilization is required.

## / Playback Setup

| Menu item               | Setting options                                                                                                                                                                                                                                                                                               |  |
|-------------------------|---------------------------------------------------------------------------------------------------------------------------------------------------------------------------------------------------------------------------------------------------------------------------------------------------------------|-----------------------------------------------------------------------------------|
| [Select Music]          | <b>[OFF Off]</b> , <b>[ON On]</b><br>When <b>[ON On]</b> - list of music tracks,<br>[Music Balance]  [  ] (Original sound/Background music) | 87,<br>94                                                                         |
| [Slideshow Transition]  | <b>[OFF Off]</b> ,  Dissolve],  Slide Image]                                                                                            | –                                                                                 |
| [Video Snapshot Length] | <b>[2sec 2 sec]</b> , <b>[4sec 4 sec]</b> , <b>[8sec 8 sec]</b>                                                                                                                                                                                                                                               | 71,<br>85                                                                         |

- **[Slideshow Transition]:** You can select the transition effect between images in a slideshow ( 94).

## Display Setup

| Menu item                  | Setting options                                                                                                                                                                                                                                                                                                                                                                                                               |  |
|----------------------------|-------------------------------------------------------------------------------------------------------------------------------------------------------------------------------------------------------------------------------------------------------------------------------------------------------------------------------------------------------------------------------------------------------------------------------|-----------------------------------------------------------------------------------|
| [Onscreen Markers]         | [ <b>OFF</b> Off], [  Level (White)], [  Level (Gray)], [  Grid (White)], [  Grid (Gray)] | –                                                                                 |
| [Display Date/Time]        | [ <b>ON</b> On], [ <b>OFF</b> Off]                                                                                                                                                                                                                                                                                                                                                                                            | –                                                                                 |
| [Output Onscreen Displays] | [ <b>ON</b> On], [ <b>OFF</b> Off]                                                                                                                                                                                                                                                                                                                                                                                            | –                                                                                 |
| [LCD Brightness]           |                                                                                                                                                                                                                                                                                                                                              | –                                                                                 |
| [LCD Backlight]            | [ <b>H</b> Bright], [ <b>M</b> Normal], [ <b>L</b> Dim]                                                                                                                                                                                                                                                                                                                                                                       | –                                                                                 |
| [LCD Mirror Image]         | [ <b>ON</b> On], [ <b>OFF</b> Off]                                                                                                                                                                                                                                                                                                                                                                                            | –                                                                                 |
| [HDMI Status]              | –                                                                                                                                                                                                                                                                                                                                                                                                                             | –                                                                                 |
| [Demo Mode]                | [ <b>ON</b> On], [ <b>OFF</b> Off]                                                                                                                                                                                                                                                                                                                                                                                            | –                                                                                 |
| [TV Type]                  | [ <b>4:3</b> 4:3 TV], [ <b>16:9</b> Wide TV]                                                                                                                                                                                                                                                                                                                                                                                  | –                                                                                 |

**[Onscreen Markers]:** While recording, you can display a grid or a horizontal line at the center of the screen. Use the markers as a reference to make sure your subject is framed correctly (vertically and/or horizontally).

- Using the onscreen markers will not affect the recordings.

**[Display Date/Time]:** Select whether to display the date and time during playback.

- For MP4 movies, only the date will be displayed.

**[Output Onscreen Displays]:** When this setting is set to [**ON** On], the camcorder's onscreen displays will appear also on the screen of a TV or monitor connected to the camcorder.

**[LCD Brightness]:** Adjusts the brightness of the LCD screen.

- Changing the brightness of the LCD screen does not affect the brightness of your recordings or the brightness of the playback image on a TV.

**[LCD Backlight]:** Sets the screen to one of three brightness levels.

- Changing the brightness of the LCD screen does not affect the brightness of your recordings or the brightness of the playback image on a TV.
- Using the [**H** Bright] setting will shorten the effective usage time of the battery pack.

- When the compact power adapter is connected, [LCD Backlight] will automatically change to [H Bright].

**[LCD Mirror Image]:** When this setting is set to [**ON** On], this function reverses the image on the screen horizontally when you rotate the LCD panel 180 degrees toward the subject. In other words, the screen will show a mirror image of the subject.

- While the LCD panel is rotated toward the subject you will not be able to decorate the scene.

**[HDMI Status]:** Displays a screen where you can verify the standard of the output signal from the HDMI OUT terminal.

**[Demo Mode]:** The demonstration mode displays the camcorder's main features. It starts automatically when the camcorder is powered with the compact power adapter if you leave it turned on in recording mode without a memory card for more than 5 minutes.

- To cancel the demo mode once it has started, press any button or turn off the camcorder.

















**[TV Type]:** When you connect the camcorder to a TV using the optional STV-250N Stereo Video Cable, select the setting according to the type of TV in order to display the picture in full and in the correct aspect ratio.





**[4:3** 4:3 TV]: TV sets with 4:3 aspect ratio.

**[16:9** Wide TV]: TV sets with 16:9 aspect ratio.

- When the TV type is set to [**4:3** 4:3 TV], during the playback of video originally recorded with an aspect ratio of 16:9, the picture will not be displayed fullscreen.
- This function is not available when the camcorder is connected to an HDTV using the supplied High Speed HDMI cable.

## System Setup

| Menu item                                                                                   | Setting options                                                                                                                                                                                                                                                                                                                                                 |  |
|---------------------------------------------------------------------------------------------|-----------------------------------------------------------------------------------------------------------------------------------------------------------------------------------------------------------------------------------------------------------------------------------------------------------------------------------------------------------------|-----------------------------------------------------------------------------------|
| [Language  | [Česky], [Dansk], [Deutsch], [Ελληνικά], [English], [Español], [Français], [Italiano], [Magyar], [Melayu], [Nederlands], [Norsk], [Polski], [Português], [Română], [Suomi], [Svenska], [Türkçe], [Русский], [Українська], [العربية], [فارسی], [ภาษาไทย], [简体中文], [繁體中文], [한국어], [日本語]                                                                           | 26                                                                                |
| [Time Zone/DST]                                                                             | [  ] (home time zone) or [  ] (travel time zone):<br>[New York], list of world time zones<br>[*] (DST adjustment): Toggle on or <u>off</u>                                                    | 28                                                                                |
| [Date/Time]                                                                                 | [Date/Time]: –<br>[Date Format]:<br>[Y.M.D], [ <u>M.D.Y</u> ], [D.M.Y] (Y- year, M- month, D- day)<br>[24H]: Toggle on (24-hour clock) or <u>off</u> (12-hour clock)                                                                                                                                                                                            | 26                                                                                |
| [Available Space in Memory]                                                                 | <b>HF R52/R50</b><br>[  ] (built-in memory), [ <u>SD</u> ] (memory card)                                                                                                                                                                                                       | –                                                                                 |
| [Used Space in Memory]                                                                      | <b>HF R52/R50</b><br>[  ] (built-in memory), [ <u>SD</u> ] (memory card)                                                                                                                                                                                                       | –                                                                                 |
| <b>HF R52/R50</b><br>[External Hard Drive Info]*                                            | –                                                                                                                                                                                                                                                                                                                                                               | –                                                                                 |
| [AV/Headphones]                                                                             | [ <b>AV</b> AV], [  Headphones]                                                                                                                                                                                                                                                | 82                                                                                |
| [Volume]                                                                                    | [Speaker]:<br> , <b>OFF</b>                                                                                                                                                                                                                                                    | 49                                                                                |
|                                                                                             | [Headphones]:<br> , <b>OFF</b>                                                                                                                                                                                                                                                | 82                                                                                |
| [Notification Sounds]                                                                       | [  ] High Volume], [  ] Low Volume], [ <b>OFF</b> Off]                                                                                                                                    | –                                                                                 |
| [Custom Control Button]                                                                     | You can select one of the functions in the [  Main Functions] panel (  142)<br>Default: [  Decoration] | –                                                                                 |
| [Battery Info]                                                                              | –                                                                                                                                                                                                                                                                                                                                                               | –                                                                                 |
| [Displayed Units]                                                                           | [ <b>m</b> Meters/Grams], [ <b>ft</b> Feet/Pounds]                                                                                                                                                                                                                                                                                                              | –                                                                                 |
| [File Numbering]                                                                            | [  Reset], [  Continuous]                                                                                                                                                                 | –                                                                                 |
| [Auto Power Off]                                                                            | [ <b>ON</b> On], [ <b>OFF</b> Off]                                                                                                                                                                                                                                                                                                                              | –                                                                                 |

| Menu item                                                                                                              | Setting options                                                                                                                                                                                                      |  |
|------------------------------------------------------------------------------------------------------------------------|----------------------------------------------------------------------------------------------------------------------------------------------------------------------------------------------------------------------|---------------------------------------------------------------------------------|
| [Power On Using LCD Panel]                                                                                             | [Enable], [Off]                                                                                                                                                                                                      | –                                                                               |
| <b>HFR52/R50</b><br>[Initialize  /SD] | <b>HFR52/R50</b><br> Built-in Mem.], [  Mem. Card] | 29                                                                              |
| <b>HFR500</b><br>[Initialize  ]       | [Complete Initialization]: Toggle on or <u>off</u>                                                                                                                                                                   |                                                                                 |
| <b>HFR52/R50</b><br>[Initialize <b>HDD</b> ]*                                                                          | –                                                                                                                                                                                                                    | 113                                                                             |
| [Firmware]                                                                                                             | –                                                                                                                                                                                                                    | –                                                                               |
| <b>HFR52/R50</b><br>[Delete Memory Save Folder]*                                                                       | –                                                                                                                                                                                                                    | 112                                                                             |
| [Reset All]                                                                                                            | [No], [Yes]                                                                                                                                                                                                          | –                                                                               |

\* Option available only after connecting an external hard drive to the camcorder.

**[Available Space in Memory]/[Used Space in Memory]:** In recording mode, [Available Space in Memory] displays an information screen where you can check the available space on the memory, approximate remaining recording times (AVCHD and MP4 movies) and number of photos that can be recorded. In playback mode, [Used Space in Memory] displays an information screen where you can check the used space on the memory, the total recording time (AVCHD and MP4 movies) and the number of photos recorded.

- Estimated figures about available movie recording time and available number of photos are approximate and based on the currently selected video quality and a photo size of 1920x1080.
- In the information screen of a memory card you can also check its Speed Class.
- **HFR52/R50** The [Total space] shown for the built-in memory indicates actually usable space. It may be slightly smaller than the nominal built-in memory capacity listed in the specifications.

**[External Hard Drive Info]:** During playback mode, when the camcorder is connected to an external hard drive, this setting displays information about the hard drive.



**[Notification Sounds]:** A beep will accompany some operations like turning on the camcorder, the self-timer countdown, etc.

- Set to [OFF Off] to turn off notification sounds.
- While pre-recording (📖 144) is activated, the camcorder will not emit some notification sounds.

**[Custom Control Button]:** A control button, which serves as a shortcut to one of the functions in the [🔑 Main Functions] panel, is displayed on the lower right of the recording screen. By changing this setting, you can change the shortcut, which will allow you to access one of your frequently used functions quickly and conveniently.

- When the shooting mode is set to [📷], this function is automatically set to [🎨 Decoration] and it cannot be changed.

**[Battery Info]:** When you are using a battery pack that is compatible with Intelligent System, this option displays a screen where you can verify the battery charge (as a percentage) and the remaining recording time (during recording mode) or playback time (during playback mode).

- If the battery pack is exhausted, the battery information may not be displayed.

**[Displayed Units]:** In recording mode, this setting selects the units to use for the focusing distance display during manual focus. It also affects the units used in the stamps for height and weight in [📷] mode.

**[File Numbering]:** MP4 movies and photos are saved as files in folders, which are assigned consecutive file numbers. This setting determines how files are numbered.

[🔄 Reset]: File numbers will restart from 100-0001 every time you record on a memory that has been initialized.

[➡ Continuous]: File numbers will continue from the number following that of the last file recorded with the camcorder.

- If the memory card you insert already contains a file with a larger number, a new file will be assigned a number one higher than that of the last file on the memory card.
- We recommend using the [➡ Continuous] setting.
- A folder can contain a maximum of 500 files (MP4 movies and photos combined).
- File numbers consist of 7 digits, for example “101-0107”. The 3 digits before the hyphen indicate the folder where the file is saved and can range from 100 to 999. The 4 digits after the hyphen are a unique identifier for each file and can range from 0001 to 9900.
- The last four digits of the folder name indicate the date when the folder was created.

- The file number and folder name also indicate the location of the file on the memory card. A recording with the file number “101-0107”, made on 3 November will be found in the folder DCIM\101\_1103. If it is an MP4 movie, its file name will be MVI\_0107.MP4; if it is a photo, its file name will be IMG\_0107.JPG.

**[Auto Power Off]:** In order to save power when the camcorder is powered by a battery pack, it will automatically shut off if left without any operation for 3 minutes.

- Approximately 30 seconds before the camcorder shuts off, [Auto Power Off] will appear. Operating any of the camcorder’s controls while the message is displayed will prevent the camcorder from shutting off.

**[Power On Using LCD Panel]:** When this setting is set to [Enable], opening the LCD panel turns the camcorder on, while closing the LCD panel turns it off. Set to [Off] to deactivate this feature. In either case, you can still use **ON/OFF** .

**[Firmware]:** In playback mode, you can verify the current version of the camcorder’s firmware, which is the software that controls the camcorder. This menu option is usually unavailable.

**[Reset All]:** Resets all of the camcorder’s settings, including the date and time and all Wi-Fi settings and passwords.

# Appendix: Onscreen Icons and Displays

## Recording Movies

**AUTO** and  modes  
(with the zoom control displayed)

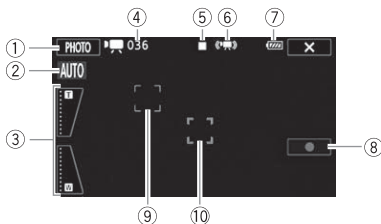

- ① Control button [PHOTO]: Take a photo (📖 40, 86)
- ② Smart AUTO\* (📖 42)
- ③ Zoom controls (📖 44)
- ④ Total number of scenes / Total recording time
- ⑤ Memory operation (📖 158)
- ⑥ Intelligent IS (📖 43)
- ⑦ Remaining battery charge (📖 158)
- ⑧ Control button [●]/[■]: Start/Stop recording a movie (📖 37)
- ⑨ Face detection frame (📖 72)
- ⑩ Tracking frame (📖 72)

\* Available only in **AUTO** mode.

## Recording Movies

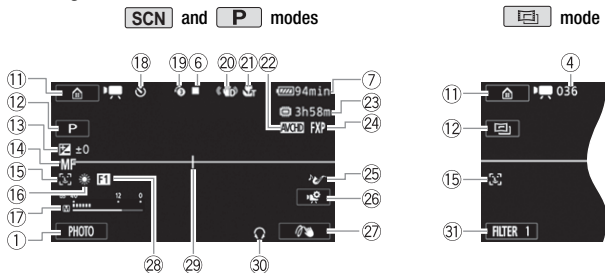

- ① Control button [🏠]: Open the 🏠 (Home) menu (📖 32)
- ② Shooting mode (📖 59)
- ③ Exposure (📖 75)
- ④ Focus (📖 76)
- ⑤ Face detection (📖 72)
- ⑥ White balance (📖 78)
- ⑦ Audio level indicator (📖 144)
- ⑧ While recording/during playback:  
Scene counter (hours : minutes : seconds); ⌚ Self timer (📖 146)
- ⑨ Pre-recording (📖 144)
- ⑩ Image stabilizer (📖 148)
- ⑪ Tele macro (📖 80)
- ⑫ Movie format (📖 56)
- ⑬ Remaining recording time  
📁 On the memory card  
📁 In the built-in memory\*
- ⑭ Relay recording\* (📖 58)
- ⑮ Video quality (📖 56)
- ⑯ Audio scene (📖 81)
- ⑰ Control button [🔧]: Open the [🔧 Main Functions] panel (📖 142)
- ⑱ Custom control button (📖 153)
- ⑲ Fader (📖 74)
- ⑳ Level marker (📖 149)
- ㉑ Headphone output (📖 82)
- ㉒ Control button [FILTER 1]: Cinema-look filters (📖 61)

\* HFR52/R50 only.

## Playing Movies (during playback)

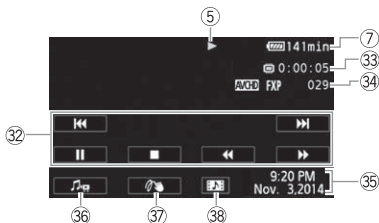



32 Playback control buttons (  48)



33 Scene playback time

34 Scene number

35 Date/Time (  149)

36 Volume and background music balance controls (  49, 88)

37 Decoration (  65)

38 Control button []: Capture a video snapshot scene (  85)

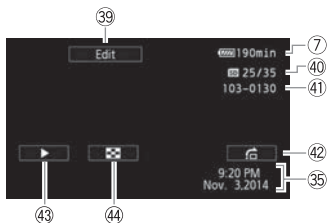

## Viewing Photos







39 Control button [Edit]: Open the Edit panel (  145)

40 Current photo / Total number of photos

41 File number (  153)

42 Control button []: Photo jump (  52)

43 Control button []: Slideshow (  94)

44 Control button []: Return to the [] index screen (  50)





### ⑤ Memory operation

- Record, ■ Recording standby, ▶ Playback, || Playback pause, ►► Fast playback, ◀◀ Fast reverse playback, ► Slow playback, ◀ Slow reverse playback, ►► Frame advance, ◀|| Frame reverse.

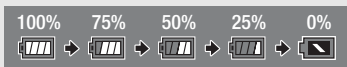

### ⑦ Remaining battery charge

- The icon shows a rough estimate of the remaining charge as a percentage of the full charge of the battery pack.



- When the battery charge becomes low, replace or charge the battery pack. Depending on the condition of the camcorder or battery, the actual battery charge may not match what is displayed on the screen.
- When you attach an empty battery pack, the power may turn off without displaying .
- Depending on the conditions under which the camcorder and the battery pack are used, the actual battery charge may not be indicated accurately.
- You can display the charge status of a battery pack with the     [Battery Info] setting.

### ⑳ Remaining recording time

When there is no more free space on the memory, [ End] (built-in memory, **HFR52/R50** only) or [ End] (memory card) will be displayed in red and the recording will stop.

# Troubleshooting

If you have a problem with your camcorder, refer to this section. Sometimes what you think is a malfunction of the camcorder may have the simplest of solutions - please read the "CHECK THIS FIRST" box before going on to the more detailed problems and solutions. Consult your dealer or a Canon Service Center if the problem persists.

## CHECK THIS FIRST

### Power supply

- Is the battery charged? Is the compact power adapter correctly connected to the camcorder? (📖 20)

### Recording

- Did you turn the camcorder on and correctly set it to a recording mode? (📖 37, 40) If you are recording on a memory card, is one correctly inserted into the camcorder? (📖 24)

### Playback

- Did you turn the camcorder on and correctly set it to playback mode? (📖 46, 50) If you are playing back recordings from a memory card, is one correctly inserted into the camcorder? (📖 24) Does it contain any recordings?

## Power source

---

**The camcorder will not turn on or it turns off by itself.**

- The battery pack is exhausted. Replace or charge the battery pack.
- Remove the battery pack and reattach it correctly.

**Cannot charge the battery pack.**

- Make sure the camcorder is off so charging can start.
- The temperature of the battery pack is outside its operating range (approximately 0 – 40 °C (32 – 104 °F)). Remove the battery pack, warm it or let it cool down, as necessary, and try charging it again.
- Charge the battery pack in temperatures between approximately 0 °C and 40 °C (32 °F and 104 °F).
- The battery pack is faulty. Replace the battery pack.
- The camcorder cannot communicate with the battery pack attached. Battery packs not recommended by Canon for use with this camcorder cannot be charged using this camcorder.
- If you are using a battery pack recommended by Canon for use with this camcorder, there may be a problem with the camcorder or battery pack. Consult a Canon Service Center.

**A noise can be heard from the compact power adapter.**

- A faint sound can be heard while the compact power adapter is connected to a power outlet. This is not a malfunction.









**The battery pack is exhausted extremely quickly even at normal temperatures.**

- The battery may have reached the end of its battery life. Buy a new battery pack.

## Recording

---



**Pressing  will not start recording.**

- You cannot record while the camcorder is writing previous recordings onto the memory (while the ACCESS indicator is on or flashing). Wait until the camcorder has finished.
- The memory is full or it already contains the maximum number of AVCHD movies (3,999 scenes). Delete some recordings ( 53) or initialize the memory ( 29) to free some space.
- The file or folder number has reached its maximum value. Save your recordings ( 105), set     [File Numbering] to [Reset] and initialize the memory ( 29).

**The point where  was pressed does not match the beginning/end of the recording.**



- There is a slight interval between pressing  and the actual start/end of recording. This is not a malfunction.



**The camcorder will not focus.**

- Autofocus does not work on the subject. Focus manually ( 76).
- The lens is dirty. Clean the lens ( 179).



**When a subject flits across in front of the lens, the image appears slightly bent.**

- This is a phenomenon typical of CMOS image sensors. When a subject crosses very quickly in front of the camcorder, the image may seem slightly warped. This is not a malfunction.



**Changing the operating mode between recording ()/recording standby ()/playback () takes longer than usual.**

- When the memory contains a large number of scenes, some operations may take longer than usual. Save your recordings ( 105) and initialize the memory ( 29).

**Movies or photos cannot be recorded properly.**

- This may occur as movies and photos are recorded/deleted over time. Save your recordings ( 105) and initialize the memory using the [Complete Initialization] option ( 29).

**Cannot record a photo while recording movies.**

- You cannot take photos in  mode or while fading in or fading out a scene ( 74).

**After using the camcorder for a long time, it becomes hot.**

- The camcorder may become hot after using it continuously for long periods of time; this is not a malfunction. If the camcorder becomes unusually hot or it becomes hot after using it only for a short while, it may indicate a problem with the camcorder. Consult a Canon Service Center.



## Playback

---

Deleting scenes takes longer than usual.

- When the memory contains a large number of scenes, some operations may take longer than usual. Save your recordings (📖 105) and initialize the memory (📖 29).

Cannot capture a video snapshot scene from a movie.

- You cannot capture video snapshot scenes from scenes recorded or edited using another device. Also, you cannot capture video snapshot scenes from MP4 movies.
- The memory is full. Delete some recordings (📖 53) to free some space.

When playing back scenes/slideshow with background music, the music track is not played back correctly.

- This can occur when you transfer the music files to a memory card after repeatedly recording and deleting scenes (fragmented memory). Save your recordings (📖 105) and initialize the memory card using the [Complete Initialization] option (📖 29). Then, transfer the music files first and only then transfer the video files.
- Music tracks will not play back correctly if the connection was interrupted while transferring the music files to a memory card. Delete the music tracks and transfer the music files again.
- The transfer rate of the memory card used is too slow. Use a recommended memory card (📖 23).

Cannot divide scenes

- The memory is full. Delete some recordings (📖 53) to free some space.

Cannot mark individual scenes/photos in the index screen with a checkmark ✓

- You cannot select more than 100 scenes/photos individually. Select the [All Scenes] or [All Photos] option instead of [Select].

## Indicators and Onscreen Displays

---

 lights up in red.

- Battery pack is exhausted. Replace or charge the battery pack.

 appears on the screen.

- The camcorder cannot communicate with the battery pack attached so the remaining battery charge cannot be displayed.

 lights up in red.

- A memory card error occurred. Turn off the camcorder. Remove and reinsert the memory card. Initialize the memory card if the display does not change back to normal.

 and [End] appear in red on the screen.

- The memory card is full. Replace the memory card or delete some recordings (📖 53) to free some space on the memory card.

Even after stopping recording, the ACCESS indicator does not go off.

- The scene is being recorded in the memory. This is not a malfunction.

The red ON/OFF (CHG) indicator flashes rapidly ( one flash at 0.5-second intervals).

- The temperature of the battery pack is outside its operating range (approximately 0 – 40 °C (32 – 104 °F)). Remove the battery pack, warm it or let it cool down, as necessary, and try charging it again.
- Charge the battery pack in temperatures between approximately 0 °C and 40 °C (32 °F and 104 °F).
- The battery pack is damaged. Use a different battery pack.
- Charging has stopped because the compact power adapter or the battery pack is faulty. Consult a Canon Service Center.

## Picture and Sound

---

A rattling can be heard from the camcorder.

- If it cannot be heard during camera mode, then the rattling is due to the movement of the internal lens fixture. This is not a malfunction.

The screen appears too dark.

- The LCD screen was dimmed. Change the     [LCD Backlight] setting to [Normal] or [Bright].

Screen displays turn on and off repeatedly.

- The battery pack is exhausted. Replace or charge the battery pack.
- Remove the battery pack and reattach it correctly.





Abnormal characters appear on the screen and the camcorder does not operate properly.

- Disconnect the power source and reconnect it after a short time.

Video noise appears on screen.

- Keep a distance between the camcorder and devices that emit strong electromagnetic fields (plasma TVs, cellular phones, etc.).

Horizontal bands appear on the screen.





- This is a phenomenon typical of CMOS image sensors when recording under some types of fluorescent, mercury or sodium lamps. This is not a malfunction. To reduce the symptoms, change the     [Flicker Reduction] setting.

Sound is distorted or is recorded at lower levels.

- When recording near loud sounds (such as fireworks, shows or concerts), sound may become distorted or it may not be recorded at the actual levels. Adjust the audio recording level manually ( 144).

The picture is displayed correctly but there is no sound from the built-in speaker.

- Speaker volume is turned off. Adjust the volume.

- If the supplied HTC-100/S High Speed HDMI Cable or optional STV-250N Stereo Video Cable is connected to the camcorder, disconnect it.
- The AV OUT/⌋ terminal is set to headphone output. Set     [AV/Headphones] to [AV].

**There is no sound from the headphones.**

- **HFR52/R50** Audio will not be output from the AV OUT/⌋ terminal while Wi-Fi functions are in use.







## Memory Card and Accessories

---

**Cannot insert the memory card.**

- The memory card was not facing the correct direction. Turn the memory card over and insert it.

**Cannot record on the memory card.**

- The memory card is full. Delete some recordings ( 53) to free some space or replace the memory card.
- Initialize the memory card ( 29) when you use it with the camcorder for the first time.
- The LOCK switch on the memory card is set to prevent accidental erasure. Change the position of the LOCK switch.
- A compatible memory card must be used to be able to record movies on a memory card ( 23).
- The file numbers have reached their maximum value. Set     [File Numbering] to [Reset] and insert a new memory card.

## Connections with External Devices

---

**Video noise appears on the TV screen.**

- When using the camcorder in a room where a TV is located, keep a distance between the compact power adapter and the power or antenna cables of the TV.

**Playback looks fine on the camcorder but there is no image on the TV screen.**

- The video input on the TV is not set to the video terminal to which you connected the camcorder. Select the correct video input.
- Video and audio will not be output from the AV OUT/⌋ terminal while the supplied High Speed HDMI cable is connected. Disconnect the cable.

**The camcorder is connected using the supplied High Speed HDMI cable, but there is no picture or sound from the HDTV.**

- Disconnect the supplied High Speed HDMI cable and then restore the connection or turn the camcorder off and then on again.

There is no image on the TV screen and there is no sound.

- **HFR52/R50** Video and audio will not be output from the camcorder while Wi-Fi functions are in use.

The computer does not recognize the camcorder even though the camcorder is connected correctly.

- Disconnect the USB cable and turn off the camcorder. After a short while, turn it on again and restore the connection.
- Connect the camcorder to a different USB port on the computer.

Cannot save MP4 movies or photos on my computer

- When the memory contains too many MP4 movies or photos (Windows – 2,500 scenes/photos or more, Mac OS – 1,000 scenes/photos or more), you may not be able to transfer recordings to a computer. Try using a card reader to transfer the recordings on the memory card.  
**HFR52/R50** only: To transfer the recordings in the built-in memory, copy them to the memory card in advance (📖 95).

## **HFR52/R50** Wi-Fi Functions

---

Refer also to the instruction manual of your access point and other devices you will use.

Cannot connect with the access point.

- Check that the access point is working correctly.
- The effective communication range between the camcorder and access point may vary depending on the strength of the wireless signal. Try using the camcorder closer to the access point.
- Cordless phones, microwave ovens, refrigerators and other appliances in the line of sight between the access point and the camcorder may interfere with the wireless signal. Try using the camcorder in a location farther away from such appliances.
- Wi-Fi networks with a stealth function that do not broadcast their network name (SSID) will not be detected by the camcorder during the Wi-Fi network setup. Perform the setup manually (📖 136) or turn off the stealth function of the access point.





Wireless playback on a computer or similar device is not smooth.

- Playback may not be smooth depending on the access point's settings and capabilities.
- Connect the computer to the access point using a LAN cable.
- Remove any objects between the camcorder and wireless access point that may interfere with the wireless signal.
- Move the camcorder closer to the wireless access point.
- Turn off the wireless functions of other wireless devices other than the computer or similar device being used for playback.
- Switch the wireless access point to IEEE802.11n. Refer to its instruction manual for details.
- If these do not solve the issue, the cause may be due the device or conditions unique to the surrounding area. Use the supplied High Speed HDMI cable to connect the camcorder to a TV (📖 101).

The wireless connection was interrupted while transferring files.

- Incomplete files may remain at the transfer destination. If incomplete files remain at the transfer destination, check the content and make sure they are safe to delete before deleting them.
- Select [New Files] and perform the file transfer again.



Cannot connect a Wi-Fi-enabled external device wirelessly to the camcorder.

- Use the     [Reset All] setting to reset the camcorder. The camcorder's SSID will return to the default setting and the password will change. Delete the previous network settings from the external device and try to connect it to the camcorder.

The Remote Browse screen does not appear correctly on the Web browser.

- The device, operating system or Web browser used may not be supported. For the latest information about supported systems, visit your local Canon Web site.
- Enable JavaScript and cookies in your Web browser's settings. For details, refer to the help modules or online documentation of the Web browser used.

## List of Messages (in alphabetical order)

**HFR52/R50** Refer to *List of Messages for Connecting to an External Hard Drive* ( 171) for messages related to an external hard drive, *List of Messages for Wi-Fi Functions* ( 171) for a list of messages related to general Wi-Fi functions, and *List of Messages for Web Services* ( 174) for messages related to Web services when using Wi-Fi functions.





Back up recordings regularly

- This message may appear when you turn on the camcorder. In the event of a malfunction, recordings may be lost so back up your recordings regularly.

**HFR52/R50** Built-in memory error

- The built-in memory could not be read. Contact a Canon Service Center.

**HFR52/R50** Built-in memory is full

- The built-in memory is full ( End] appears on the screen). Delete some recordings ( 53) to free some space. Alternatively, save your recordings ( 105) and initialize the built-in memory ( 29).

**HFR52/R50** Built-in memory writing error Attempt to recover the data?

- This message will appear the next time you turn on the camcorder if power supply was accidentally interrupted while the camcorder was writing to the built-in memory. Select [Yes] to try to recover the recordings.

**HFR52/R50** Cannot access the built-in memory

- There is a problem with the built-in memory. Contact a Canon Service Center.

### **Cannot communicate with the battery pack. Continue using this battery pack?**

- You attached a battery pack that is not recommended by Canon for use with this camcorder.
- If you are using a battery pack recommended by Canon for use with this camcorder, there may be a problem with the camcorder or battery pack. Consult a Canon Service Center.

### **Cannot convert scenes recorded at 60P**

- Scenes that were recorded at 60P cannot be converted to MP4.

### **Cannot convert the scene**

- You cannot convert scenes recorded using another device.

### **HFR52/R50 Cannot copy**

- The total size of the scenes you selected to copy exceeds the available space on the memory card. Delete some recordings on the memory card (📖 53) or reduce the number of scenes to copy.
- The memory card already contains the maximum number of AVCHD scenes (3,999 scenes). Delete some scenes (📖 53) to free some space.

### **Cannot divide the scene**

- The scene could not be divided because the camcorder's internal scene management data log is full. Delete some scenes and photos (📖 53) and try dividing the scene again.

### **Cannot join 24P and 30P scenes to convert them**

- Scenes recorded with a frame rate of 24P cannot be joined with those recorded with a frame rate of 30P.

### **Cannot load canvas**

- The canvas file that was saved on the memory is corrupted.
- Canvas data cannot be read from canvas files created using other devices.

### **Cannot play back**

- You may not be able to play back scenes recorded or edited using another device.
- There is a problem with the memory. If this message appears often without apparent reason, contact a Canon Service Center.

### **HFR52/R50 Cannot play back Cannot access the built-in memory**

- There is a problem with the built-in memory. Save your recordings (📖 105) and initialize the built-in memory using the [Complete Initialization] option (📖 29). If the problem persists, contact a Canon Service Center.

### **Cannot play back Check the memory card**

- There is a problem with the memory card. Save your recordings (📖 105) and initialize the memory card using the [Complete Initialization] option (📖 29). If the problem persists, use a different memory card.

### **HFR52/R50 Cannot play the movies in the built-in memory Initialize only using the camcorder**

- The camcorder's built-in memory was initialized using a computer. Initialize the built-in memory with this camcorder (📖 29).

### Cannot play the movies on this memory card

- Movies cannot be played back from a 64 MB or smaller memory card. Use a recommended memory card (📖 23).

### Cannot play the movies on this memory card Initialize only using the camcorder

- The memory card in the camcorder was initialized using a computer. Initialize the memory card with this camcorder (📖 29).

### Cannot record

- You cannot capture video snapshot scenes from scenes recorded or edited using another device.
- There is a problem with the memory. If this message appears often without apparent reason, contact a Canon Service Center.

### **HF/R52/R50** Cannot record Cannot access the built-in memory

- There is a problem with the built-in memory. Save your recordings (📖 105) and initialize the built-in memory using the [Complete Initialization] option (📖 29). If the problem persists, contact a Canon Service Center.

### Cannot record Check the memory card

- There is a problem with the memory card. Save your recordings (📖 105) and initialize the memory card using the [Complete Initialization] option (📖 29). If the problem persists, use a different memory card.

### **HF/R52/R50** Cannot record movies in the built-in memory Initialize only using the camcorder

- The camcorder's built-in memory was initialized using a computer. Initialize the built-in memory with this camcorder (📖 29).

### Cannot record movies on this memory card

- Movies cannot be recorded on a 64 MB or smaller memory card. Use a recommended memory card (📖 23).

### Cannot record movies on this memory card Initialize only using the camcorder

- The memory card in the camcorder was initialized using a computer. Initialize the memory card with this camcorder (📖 29).

### Cannot save the canvas

- Cannot save your [Pens and Stamps] drawings on the memory. Save your recordings (📖 105) and initialize the memory (📖 29).



### Cannot trim the scene

- You cannot trim scenes that were recorded using another device or copied to an SDXC memory card.

### Charge the battery pack

- Battery pack is exhausted. Charge the battery pack.

### Check the memory card

- Cannot access the memory card. Check the memory card and make sure it is inserted correctly.
- A memory card error occurred. The camcorder cannot record or display the image. Try removing and reinserting the memory card, or use a different memory card.
- You inserted a MultiMedia Card (MMC) into the camcorder. Use a recommended memory card (📖 23).
- If after the message disappears,  appears in red, perform the following: Turn off the camcorder and remove and reinsert the memory card. If  turns back to green you can resume recording/playback. If the problem persists, save your recordings (📖 105) and initialize the memory card (📖 29).

### Check whether the lens cover is open

- Slide the lens cover switch down.



**Do not disconnect the power source.** Cannot write data with this connection. To write data to the camcorder, connect the compact power adapter then reconnect the camcorder and computer. Do not disconnect the USB cable unless you first use the computer to safely end the connection.

- The camcorder cannot be operated while it is not being powered by the compact power adapter and is connected to a computer with the supplied USB cable. In addition, scenes cannot be written back and music files cannot be transferred to the camcorder. To avoid corrupting the data in the camcorder's memory, use the computer's Safely Remove Hardware function to end the connection and disconnect the USB cable before using the camcorder.
- To transfer files to the camcorder, use the computer's Safely Remove Hardware function to end the connection, disconnect the USB cable, power the camcorder using the compact power adapter and only then connect it to the computer again.

**Do not disconnect the power source.** Do not disconnect the USB cable unless you first use the computer to safely end the connection.

- When the camcorder is in  mode and is connected to the computer with the supplied USB cable, the camcorder cannot be operated. Disconnecting the USB cable or power source while this message appears may result in permanent loss of the recordings in the camcorder. Use the computer's Safely Remove Hardware function to end the connection and disconnect the USB cable before using the camcorder.



### File name error

- The file or folder number has reached its maximum value. Save your recordings (📖 105), set    [File Numbering] to [Reset] and initialize the memory (📖 29).

### Initialize only using the camcorder

- There is a problem with the file system that prevents accessing the selected memory. Initialize the memory with this camcorder (📖 29).

**LCD Screen has been dimmed** Use the [LCD Backlight] setting to change the brightness

- Change the    [LCD Backlight] setting to [Normal] or [Bright].



### **May not be possible to record movies on this memory card**

- You may not be able to record movies on a memory card without a Speed Class rating or rated CLASS 2. Replace the memory card with one rated CLASS 4, 6 or 10.

### **Mem. Card Number of scenes already at maximum**

- The memory card already contains the maximum number of AVCHD scenes (3,999 scenes); no further scenes can be copied onto the memory card. Delete some scenes (📖 53) to free some space.

### **Mem. Card Unable to recognize the data**

- The memory card contains scenes recorded using a video configuration that is not supported (PAL or SECAM). Play back the recordings in the memory card with the device originally used to record them.

### **Memory card cover is open**

- After inserting a memory card, close the memory card slot cover.

### **Memory card is full**

- The memory card is full. Delete some recordings (📖 53) to free some space or replace the memory card.

### **Memory card is write-protected**

- The LOCK switch on the memory card is set to prevent accidental erasure. Change the position of the LOCK switch.

### **Memory card writing error Attempt to recover the data?**

- This message will appear the next time you turn on the camcorder if power supply was accidentally interrupted while the camcorder was writing to the memory. Select [Yes] to try to recover the recordings. If you inserted a memory card that contains scenes recorded using another device, we recommend that you select [No].

### **Need to recover files from the memory card. Change the position of the LOCK switch on the memory card.**

- This message will appear the next time you turn on the camcorder if power supply was accidentally interrupted while the camcorder was writing on the memory card and later the position of the card's LOCK switch was changed to prevent erasure. Change the position of the LOCK switch.

### **No memory card**

- Insert a compatible memory card into the camcorder (📖 24).
- The memory card may not be inserted correctly. Insert the memory card all the way into the memory card slot until it clicks.

### **HF R52/R50 Not enough available space**

- Delete some recordings on the memory card (📖 53).
- Select [Long Play] (LP or 4 Mbps) for the video quality (📖 56).

### **Number of scenes already at maximum**

- The maximum number of AVCHD scenes (3,999 scenes) has been reached. Delete some scenes (📖 53) to free some space.

### **Recording was stopped due to insufficient write speed of the memory card**

- The data transfer rate was too high for the memory card in use and the recording was stopped. Replace the memory card with one rated CLASS 4, 6 or 10 (CLASS 6 or 10 when recording movies with a video quality of 60P or 35 Mbps).
- After repeatedly recording, deleting and editing scenes (fragmented memory), it will take longer to write data on the memory and recording may stop. Save your recordings (📖 105) and initialize the memory (📖 29).

### **HF-R52/R50** Scene recorded using another device. Cannot copy the scene.

- Scenes that were not recorded with this camcorder cannot be copied to the memory card.
- Scenes that were edited using software cannot be copied or divided.

### **Scene recorded using another device. Cannot divide the scene.**

- Scenes that were not recorded with this camcorder cannot be divided with this camcorder.
- Scenes that were edited using software cannot be copied or divided.

### **Scene recorded using another device. Cannot play back the scene.**

- Scenes that were not recorded with this camcorder cannot be played back.

### **Select the desired scene number**

- A number of scenes have the same recording date but different file control information. This can occur for example when you record movies in the area of the international date line. Select a number to display the corresponding group of scenes.

### **Some scenes could not be deleted**

- Movies that were protected/edited with other devices cannot be deleted with this camcorder.

### **HF-R52/R50** Some scenes were recorded using another device and cannot be copied.

- Scenes that were not recorded with this camcorder cannot be copied to the memory card.

### **Task in progress. Do not disconnect the power source.**

- The camcorder is updating the memory. Wait until the operation ends and do not disconnect the compact power adapter or remove the battery pack.

### **This photo cannot be displayed**

- You may not be able to display photos taken with other devices or image files created or edited on a computer.

### **To record video on this memory card, it is recommended to use [Long Play] video quality.**

- When using a memory card rated CLASS 2, you may not be able to record movies if you use a video quality option other than LP or 4 Mbps.

### **To record video on this memory card, it is recommended to use a video quality setting other than [60P Recording].**

- When using a memory card rated CLASS 4, you may not be able to record movies if you use the 60P or 35 Mbps video quality option.

**Too many photos and MP4 movies. Disconnect the USB cable.**

- Disconnect the USB cable. Try using a memory card reader or decrease the number of photos and MP4 movies on the memory card to fewer than 2,500 (Windows), or 1,000 (Mac OS).
- If a dialog box appeared on the computer screen, close it. Disconnect the USB cable, and restore the connection after a short while.

**Unable to recognize the data**

- The camcorder cannot play back scenes recorded using a video configuration that is not supported (PAL or SECAM). Play back the recordings with the device originally used to record them.

**Unable to recover data**

- Could not recover a corrupted file. Save your recordings (📖 105) and initialize the memory (📖 29).

---

## **HF R52/R50 List of Messages for Connecting to an External Hard Drive**

---

**Error writing to external hard drive**

- This message will appear the next time you turn on the camcorder if power supply was accidentally interrupted while the camcorder was writing to the external hard drive. Select [Yes] to try to recover the recordings.

**Quickly erases all files and deletes partitions from the external hard drive. Initialize?**

- If you initialize the hard drive, all data it contains will be lost, including any partitioned drives. If necessary, back up data and then initialize the hard drive with the camcorder.

---

## **HF R52/R50 List of Messages for Wi-Fi Functions**

---

Refer also to the instruction manual of your wireless router and other devices you will use.

**Another user is already controlling the camcorder. Try again later.**

- This message appears on the screen of the Wi-Fi device. Multiple Wi-Fi devices are trying to connect with the camcorder. Make sure only one Wi-Fi device is trying to connect and then touch Retry.

**Invalid port number. Perform the setting again.**

- The port number entered cannot be used. In the settings for the Monitor while Out function (📖 121) change the port number to a port that does not conflict with other devices.

**IP address conflict**

- Change the camcorder's IP address to avoid any conflict with devices connected to the same network. Alternatively, change the IP address of the conflicting device.

### Memory card cover is open

- The memory card cover was opened while the memory card was being accessed. Stop the Wi-Fi function in use and end the Wi-Fi connection.

### Multiple access points detected. Try the operation again.

- There are multiple access points sending out a WPS signal at the same time. Try the operation again later or perform setup using the [WPS: PIN Code] or [Search for Access Points] option (📖 133).

### No access points found

- The access point set in the camcorder could not be found.
- Cordless phones, microwave ovens, refrigerators and other appliances may interfere with the wireless signal. Try using the camcorder in a location farther away from such appliances.
- Make sure that you use the access point's SSID for the camcorder's Wi-Fi settings.
- If the access point is using MAC address filtering, enter the camcorder's MAC address in the access point's configuration screen.

### The access point is not compatible with UPnP

- A wireless router compatible with UPnP (Universal Plug and Play) could not be found on the Wi-Fi network. Use a UPnP-compatible wireless router. If you are using a UPnP-compatible wireless router, be sure to activate the UPnP protocol.

### Unable to access configuration files

- Turn off the camcorder. After a short while, turn it on again. If the problem persists contact a Canon Service Center.

### Unable to complete WPS.

- Turn off the camcorder and access point. After a short while, turn them on again and try again. If the problem persists, perform setup using the [Search for Access Points] option (📖 136).





### Unable to complete WPS. Try the operation again.

- Some wireless routers require pressing and holding the Wi-Fi Protected Setup (WPS) button. For details, refer to the instruction manual of your access point.
- Make sure to touch [OK] on the camcorder's screen within 2 minutes of activating the Wi-Fi Protected Setup signal on the access point, whether by pressing the button or by entering the PIN code.

### Unable to connect

- Cordless phones, microwave ovens, refrigerators and other appliances may interfere with the wireless signal. Try using the camcorder in a location farther away from such appliances.

### Unable to connect to the server

- The camcorder could not connect to the external server used for the Monitor while Out function. Make sure the access point is correctly connected to the Internet.
- Check that     [Date/Time] is set to the correct date and time.

### Unable to obtain an IP address

- If you are not using a DHCP server, connect using the [Manual Setup] option and enter the IP address using the [Manual] option ( 136).
- Turn on the DHCP server. If it is already on, make sure it is functioning properly.
- Make sure the address range for the DHCP server is sufficient.
- If you are not using a DNS server, set the DNS address to [0.0.0.0].
- Set the DNS server's IP address in the camcorder.
- Turn on the DNS server. If it is already on, make sure it is functioning properly.
- Make sure that the DNS server's IP address and the name for that address are correctly configured.
- If you are using a wireless gateway router, make sure all of the devices in the network, including the camcorder, are configured with the correct gateway address.

### Wi-Fi authentication unsuccessful

- Make sure the camcorder and access point are using the same authentication/encryption method and encryption key.
- If the access point is using MAC address filtering, enter the camcorder's MAC address in the access point's configuration screen.

### Wi-Fi cannot be used while the wireless microphone is attached

- The camcorder's Wi-Fi functions cannot be used while the optional WM-V1 Wireless Microphone is connected to the camcorder. Disconnect the microphone from the MIC terminal and turn it off.

### Wi-Fi connection terminated

- Cordless phones, microwave ovens, refrigerators and other appliances may interfere with the wireless signal. Try using the camcorder in a location farther away from such appliances.
- The camcorder may not be able to connect to the access point if too many devices are accessing it. After a short while, establish the connection again.

### Wi-Fi error Incorrect authentication method

- Make sure the camcorder and access point are correctly configured.
- Make sure the camcorder and access point are using the same authentication/encryption method and encryption key.
- If the access point is using MAC address filtering, enter the camcorder's MAC address in the access point's configuration screen.

### Wi-Fi error Incorrect encryption key

- The encryption key (password) is case sensitive so make sure to enter it correctly.

### Wi-Fi error Incorrect encryption method

- Make sure the camcorder and access point are using the same authentication/encryption method.
- If the access point is using MAC address filtering, enter the camcorder's MAC address in the access point's configuration screen.

## Wireless communication is not working correctly

- Cordless phones, microwave ovens, refrigerators and other appliances may interfere with the wireless signal. Try using the camcorder in a location farther away from such appliances.
- Turn off the camcorder and access point. After a short while, turn them on again and perform the Wi-Fi network setup again. If the problem persists contact a Canon Service Center.

## List of Messages for Web Services

---

### Check network settings

- The network settings in the camcorder are not correctly configured. Check the connection point, SSID and other network settings.

### Connect to a computer and use the dedicated software to set up This service may not be available in your region

- To use Web services, set in the camcorder the settings saved on CANON iIMAGE GATEWAY. Install ImageBrowser EX and CameraWindow in your computer and configure the settings using CANON iIMAGE GATEWAY.

### Connect to a computer and use the dedicated software to set again

- An error occurred when connecting to the CANON iIMAGE GATEWAY server. Check the settings saved on CANON iIMAGE GATEWAY and set them again in the camcorder.

### Insufficient space on server

- You have exceeded the amount of data you can save on the CANON iIMAGE GATEWAY server. Delete some data to free some space.

### Movie must be less than X min.

- You attempted to send a movie whose length exceeds the maximum length allowed by the Web service (the maximum length differs according to the Web service). Shorten the movie and try sending it again.

### Server busy Try again later

- The CANON iIMAGE GATEWAY server is busy due to a high number of users trying to connect to the server. End the Wi-Fi connection and try again later.

### This image cannot be sent

- You attempted to send a type of recording or a file with a size that is not supported by the selected Web service. Check the recording before sending.

### Try again

- An error occurred when connecting to the CANON iIMAGE GATEWAY server or the server is temporarily down. End the Wi-Fi connection and try again.

# Handling Precautions

## Camcorder

Be sure to observe the following precautions to ensure maximum performance.

- **Save your recordings periodically.** Make sure to transfer your recordings to an external device such as a computer or digital video recorder (📖 103) and save them on a regular basis. This will protect your important recordings in case of damage and create more free space on the memory. Canon shall not be liable for any data loss.
- Do not carry the camcorder by the LCD panel. Be careful when closing the LCD panel.
- **Handle the touch screen with care.** Do not apply excessive force and do not use ballpoint pens or other hard-tipped tools to operate the touch screen. This may damage the touch screen's surface.
- Do not hold the camcorder in the same posture for long periods of times as this may cause low-temperature contact burns. Even if the camcorder does not feel too hot, prolonged contact with the same body part may cause skin redness or blistering. The use of a tripod is recommended for people with circulation problems or very sensitive skin, or when using the camcorder in very hot places.
- Do not leave the camcorder in places subject to high temperatures (like the inside of a car parked under direct sunlight), or high humidity.
- Do not use the camcorder near strong electromagnetic fields such as above TVs or near plasma TVs.
- **HFR52/R50** Do not use the camcorder's Wi-Fi functions inside hospitals, medical clinics or onboard aircraft. In addition, do not use them near medical equipment or sensitive electronic devices as it may affect their performance. In the case of pacemakers, keep the camcorder at least 22 cm (8.7 in.) away from the device.
- **HFR52/R50** The camcorder's Wi-Fi functions may be subject to interference from devices such as cordless phones and microwave ovens. Keeping as much distance as possible from these devices or using the camcorder's Wi-Fi functions at a different time of day may reduce such interference.

- Do not point the camcorder toward an intense light source, such as the sun on a sunny day or an intense artificial light source. Doing so may damage the image sensor or the camcorder's internal components.
- Do not use or store the camcorder in dusty or sandy places. The camcorder is not waterproof – avoid also water, mud or salt. If any of the above should get into the camcorder it may damage the camcorder and/or the lens.
- Be careful of heat generated by lighting equipment.
- Do not disassemble the camcorder. If the camcorder does not function properly, consult qualified service personnel.
- Handle the camcorder with care. Do not subject the camcorder to shocks or vibration as this may cause damage.
- When mounting the camcorder on a tripod, make sure that the tripod's fastening screw is shorter than 5.5 mm (0.2 in.). Using other tripods may damage the camcorder.

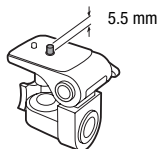

- **When recording movies, try to get a calm, stable picture.** Excessive camcorder movement while shooting and extensive use of fast zooms and panning can result in jittery scenes. In extreme cases, the playback of such scenes may result in visually induced motion sickness. If you experience such a reaction, stop the playback immediately and take a rest break as necessary.

## Long-term storage

---

If you do not intend to use the camcorder for a long time, store it in a place free of dust, in low humidity, and at temperatures not higher than 30 °C (86 °F).



## Battery Pack

### **DANGER!**

#### **Treat the battery pack with care.**

- Keep it away from fire (or it might explode).
  - Do not expose the battery pack to temperature higher than 60 °C (140 °F). Do not leave it near a heater or inside a car in hot weather.
  - Do not try to disassemble or modify it.
  - Do not drop it or subject it to shocks.
  - Do not get it wet.
- Dirty terminals may cause a poor contact between the battery pack and the camcorder. Wipe the terminals with a soft cloth.

### Long-term storage

---

- Store battery packs in a dry place at temperatures no higher than 30 °C (86 °F).
- To extend the battery life of the battery pack, discharge it completely before storing it.
- Charge and discharge all your battery packs fully at least once a year.

### Remaining battery time

---

When you are using a battery pack that is compatible with Intelligent System, if the remaining battery time displayed is not correct, charge the battery pack fully. Still, the correct time may not be displayed after a large number of repeated uses, if a fully charged battery pack is left unused, or if a battery pack is used for long periods of time in high temperatures. Use the time shown on the screen as an approximation.

## Memory Card

- We recommend backing up the recordings on the memory card onto your computer. Data may be corrupted or lost due to memory card defects or exposure to static electricity. Canon shall not be liable for lost or corrupted data.
- Do not touch or expose the terminals to dust or dirt.
- Do not use memory cards in places subject to strong magnetic fields.

- Do not leave memory cards in places subject to high humidity and high temperature.
- Do not disassemble, bend, drop, or subject memory cards to shocks and do not expose them to water.
- Check the direction before inserting the memory card. Forcing a memory card into the slot if it is not correctly oriented may damage the memory card or the camcorder.
- Do not attach any labels or stickers on the memory card.
- Secure Digital (SD) memory cards have a physical switch to prevent writing on the card so as to avoid the accidental erasure of the card's content. To write-protect the memory card set the switch to the LOCK position.

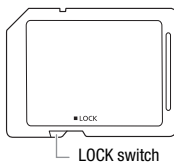

---

## Built-in Rechargeable Lithium Battery

The camcorder has a built-in rechargeable lithium battery to keep the date/time and other settings. The built-in lithium battery is recharged while you use the camcorder; however, it will discharge completely if you do not use the camcorder for about 3 months.

**To recharge the built-in lithium battery:** Connect the compact power adapter to the camcorder and leave it connected with the camcorder off. The built-in lithium battery will be fully charged after about 24 hours.

---

## Disposal

When you delete movies or initialize the memory, only the file allocation table is altered and stored data is not physically erased. When you dispose of the camcorder or memory card or give either to another person, initialize the camcorder's built-in memory (**HFR52/R50** only) or memory card using the [Complete Initialization] option (📖 29). Fill it up with unimportant recordings, and then initialize it again using the same option. This makes recovering the original recordings very difficult.

# Maintenance/Others

## Cleaning

### Camcorder Body

- Use a soft, dry cloth to clean the camcorder body. Never use chemically treated cloths or volatile solvents such as paint thinner.

### Lens

- If the lens surface is dirty, autofocus may not work properly.
- Remove any dust or dirt particles using a non-aerosol type blower brush.
- Use a clean, soft lens-cleaning cloth to gently wipe the lens. Never use tissue paper.

### LCD Touch Screen

- Clean the LCD touch screen using a clean, soft lens-cleaning cloth.
- Condensation may form on the surface of the screen when the temperature changes suddenly. Wipe it with a soft dry cloth.

## Condensation

Moving the camcorder rapidly between hot and cold temperatures may cause condensation (water droplets) to form on its internal surfaces. Stop using the camcorder if condensation is detected. Continued use may damage the camcorder.

### Condensation may form in the following cases:

- When the camcorder is moved quickly from cold to warm places.
- When the camcorder is left in a humid room.
- When a cold room is heated rapidly.

### To avoid condensation

- Do not expose the camcorder to sudden or extreme changes in temperature.

- Remove the memory card and battery pack. Then, place the camcorder in an airtight plastic bag and let it adjust gradually to temperature changes before removing it from the bag.

### **When condensation is detected**

The precise time required for water droplets to evaporate will vary depending on the location and weather conditions. As a general rule, wait for 2 hours before resuming use of the camcorder.

---

## **Using the Camcorder Abroad**

### **Power Sources**

You can use the compact power adapter to operate the camcorder and to charge battery packs in any country with power supply between 100 and 240 V AC, 50/60 Hz. Consult a Canon Service Center for information on plug adapters for overseas use.

### **Playback on a TV Screen**

You can only play back your recordings on TVs compatible with the NTSC system or 60-Hz digital TV broadcasts. These are used in the following regions/countries:

**Americas:** All of North America and Central America; most Caribbean islands (except in French territories like Guadeloupe and Martinique); most of South America (except in Argentina, Brazil and Uruguay). **Asia:** Only in Japan, the Philippines, South Korea, Taiwan and Myanmar. **Oceania:** US territories (Guam, American Samoa, etc.) and some Pacific islands like Micronesia, Samoa and Tonga.

## Optional Accessories

The following optional accessories are compatible with this camcorder but their availability may differ from area to area. Select accessories are described in more detail in the following pages.



BP-718, BP-727 Battery Pack

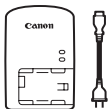

CG-700 Battery Charger

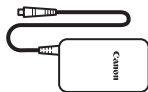

CA-110 Compact Power Adapter



HTC-100 High Speed HDMI Cable



STV-250N  
Stereo Video Cable



IFC-400PCU  
USB Cable



UA-100 USB Adapter\*



WM-V1 Wireless Microphone



SC-2000  
Soft Carrying Case

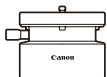

CT-V1 Camera Pan Table

\* This accessory is used in a function available only on the **HF R52/R50**.

Call or visit your local retailer/dealer for genuine Canon video accessories. You can also obtain genuine accessories for your Canon camcorder by calling: 1-800-828-4040, Canon U.S.A. Information Center.

### **Use of genuine Canon accessories is recommended.**

This product is designed to achieve excellent performance when used with genuine Canon accessories. Canon shall not be liable for any damage to this product and/or accidents such as fire, etc., caused by the malfunction of non-genuine Canon accessories (e.g., a leakage and/or explosion of a battery pack). Please note that this warranty does not apply to repairs arising out of the malfunction of non-genuine Canon accessories, although you may request such repairs on a chargeable basis.

### **Battery Packs**

When you need extra battery packs, select one of the following models: BP-718 or BP-727.

When you use battery packs bearing the Intelligent System mark, the camcorder will communicate with the battery and display the remaining usage time (accurate to 1 minute). You can only use and charge these battery packs with camcorders and chargers compatible with Intelligent System.

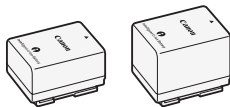

 **Intelligent Li-ion Battery**

### **CG-700 Battery Charger**

Use the battery charger to charge the battery packs.

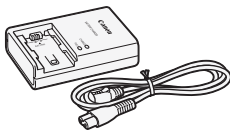

### **WM-V1 Wireless Microphone**

Reliably record rich sound even when shooting subjects at a distance. The transmitter is conveniently equipped with a clothing clip and the receiver can be attached to the camcorder's grip belt.

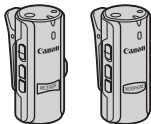

### UA-100 USB Adapter

**HFR52/R50** Allows you to connect to the camcorder an external hard drive or similar storage device with a standard-A cable. After doing so, you can save an entire memory onto the device. Check in advance the USB cable supplied with your external hard drive.

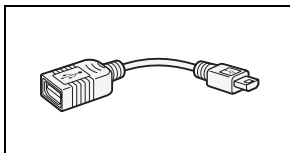

### SC-2000 Soft Carrying Case

A handy camcorder bag with padded compartments and plenty of space for accessories.



This mark identifies genuine Canon video accessories. When you use Canon video equipment, we recommend Canon-brand accessories or products bearing the same mark.



# Specifications

## VIXIA HF R52 / VIXIA HF R50 / VIXIA HF R500

◆ — Values given are approximate figures.

### System

#### • Recording System

Movies: AVCHD\* Video: MPEG-4 AVC/H.264;

Audio: Dolby Digital 2ch

MP4 Video: MPEG-4 AVC/H.264

Audio: MPEG-4 AAC-LC (2ch)

Photos: DCF (Design rule for Camera File system), compatible with Exif\*\* Ver. 2.3

Image compression: JPEG

\* Compatible with AVCHD ver. 2.0 specifications.

\*\* This camcorder supports Exif 2.3 (also called "Exif Print"). Exif Print is a standard for enhancing the communication between camcorders and printers. By connecting to an Exif Print-compliant printer, the camcorder's image data at the time of shooting is used and optimized, yielding extremely high quality prints.

#### • Video Signal Configuration

AVCHD, MP4

#### • Recording Media

- **HFR52/R50** Built-in memory: **HFR52** 32 GB, **HFR50** 8 GB

- SD, SDHC (SD High Capacity) or SDXC (SD eXtended Capacity) memory card (not included)

#### • Maximum Recording Time◆

**HFR52** 32 GB built-in memory

AVCHD movies:

**60P:** 2 hr. 30 min.

**MXP:** 2 hr. 55 min.

**FXP:** 4 hr. 10 min.

**LP:** 12 hr. 15 min.

MP4 movies:

**35 Mbps:** 2 hr.

**24 Mbps:** 2 hr. 55 min.

**17 Mbps:** 4 hr. 10 min.

**4 Mbps:** 17 hr. 20 min.

**HFR50** 8 GB built-in memory

AVCHD movies:

**60P:** 35 min.

**MXP:** 40 min.

**FXP:** 1 hr.

**LP:** 3 hr.

MP4 movies:

**35 Mbps:** 30 min.

**24 Mbps:** 40 min.

**17 Mbps:** 1 hr.

**4 Mbps:** 4 hr. 20 min.

Commercially available 16 GB memory card

AVCHD movies:

**60P:** 1 hr. 15 min.

**MXP:** 1 hr. 25 min.

**FXP:** 2 hr. 5 min.

**LP:** 6 hr. 5 min.



MP4 movies:

**35 Mbps:** 1 hr.

**24 Mbps:** 1 hr. 25 min.

**17 Mbps:** 2 hr. 5 min.

**4 Mbps:** 8 hr. 40 min.

- **Image Sensor**

1/4.85-in. CMOS, 3,280,000 pixels<sup>◆</sup>

Effective pixels: 2,070,000 pixels<sup>◆</sup> (1920 x 1080)

When advanced zoom is on:

1920 x 1080 (wide angle), 1280 x 720 (full telephoto)

- **LCD Touch Screen:** 3 in., wide, TFT color, 230,000 dots<sup>◆</sup>, touch operation

- **Microphone:** Stereo electret condenser microphone

- **Lens**

f=2.8-89.6 mm, F/1.8-4.5, 32x optical zoom, 57x advanced zoom

35 mm equivalent: 38.5 – 1,232 mm<sup>◆</sup>

32.5 – 1,853 mm<sup>◆</sup> (when advanced zoom is on)

- **Lens Configuration:** 10 elements in 7 groups (1 aspheric element)

- **AF System**

Autofocus (TTL) or Manual focus

- **Minimum Focusing Distance**

1 m (3.3 ft.); 50 cm (1.6 ft.) with tele macro on at full telephoto; 1 cm (0.39 in.) at full wide angle

- **White Balance**

Auto white balance, Custom white balance or Preset white balance settings:

Daylight, Tungsten

- **Minimum Illumination**

0.4lx ([Low Light] Special Scene mode, Shutter speed at 1/2)

5 lx ([Programmed AE] shooting mode, Auto slow shutter [On], Shutter speed at 1/30)

- **Recommended Illumination:** More than 100 lx

- **Image Stabilization:** Optical-Shift Image Stabilizer

- **Size of Video Recordings**

**AVCHD movies:**

**60P, MXP, FXP:** 1920 x 1080 pixels; **LP:** 1440 x 1080 pixels

**MP4 movies:**

**35 Mbps, 24 Mbps, 17 Mbps:** 1920 x 1080 pixels; **4 Mbps:** 1280 x 720 pixels

- **Size of Photos**

1920 x 1080 pixels

1280 x 720 pixels (when recording MP4 movies at 4 Mbps)

1920 x 1080 pixels (photos captured from a movie)

## Terminals

- **AV OUT/**  **Terminal**

Ø 3.5 mm minijack; output only (dual purpose terminal also for headphones stereo output)

Video: 1 Vp-p / 75 Ω unbalanced

Audio: -10 dBV (47 kΩ load) / 3 kΩ or less

- **USB Terminal:** mini-AB, Hi-Speed USB
- **HDMI OUT Terminal:** HDMI Mini Connector; output only
- **MIC Terminal**  
 Ø 3.5 mm stereo minijack  
 -64 dBV (with 600 Ω microphone) / 5 kΩ or more

## Wi-Fi (HFR52/R50 only)

- **Standard**  
 Complies with the IEEE 802.11b/g/n protocol; Wi-Fi Protected Setup (connection methods: WPS button, PIN code)
- **Frequency:** 2.4 GHz
- **Supported channels:** 1 - 11
- **Encryption methods:** WEP-64/WEP-128, TKIP/AES

## Power/Others

- **Power supply (rated)**  
 3.6 V DC (battery pack), 5.3 V DC (compact power adapter)
- **Power consumption** ♦ (FXP mode, AF on, LCD normal brightness)  
 3.1 W (built-in memory, HFR52/R50 only), 3.2 W (memory card)
- **Operating temperature** ♦: 0 – 40 °C (32 – 104 °F)
- **Dimensions** ♦ [W x H x D] (excluding the grip belt)  
 53 x 57 x 116 mm (2.1 x 2.2 x 4.6 in.)
- **Weight** ♦ (camcorder body only)  
 235 g (8.3 oz.)

---

## CA-110 Compact Power Adapter

- **Power supply:** 100 – 240 V AC, 50/60 Hz
- **Rated output / consumption:** 5.3 V DC, 1.5 A / 17 VA (100 V) – 23 VA (240 V)
- **Operating temperature** ♦: 0 – 40 °C (32 – 104 °F)
- **Dimensions** ♦: 49 x 27 x 79 mm (1.9 x 1.1 x 3.1 in.)
- **Weight** ♦: 110 g (3.9 oz.)

## BP-718 Battery Pack

- **Battery type**  
Rechargeable lithium ion battery
- **Rated voltage:** 3.6 V DC
- **Operating temperature** ♦: 0 – 40 °C (32 – 104 °F)
- **Battery capacity:** 1,840 mAh (typical); 6.5 Wh / 1,790 mAh (minimum)
- **Dimensions** ♦: 30.3 x 24.9 x 40.1 mm (1.2 x 0.98 x 1.6 in.)
- **Weight** ♦: 42 g (1.5 oz)

Weight and dimensions are approximate. Errors and omissions excepted.  
The information in this manual is verified as of December 2013. Subject to  
change without notice.

## Reference Tables

### Approximate recording times

◆ Default value

For AVCHD movies:

| Video quality and resolution →                      | 60P           | MXP           | FXP           | LP                  |
|-----------------------------------------------------|---------------|---------------|---------------|---------------------|
| Memory ↓                                            | (1920 x 1080) |               |               | (1440 x 1080)       |
| 8 GB Memory card/<br><b>HFR50</b> Built-in memory*  | 35 min.       | 40 min.       | 1 hr.         | 3 hr.               |
| 16 GB Memory card                                   | 1 hr. 15 min. | 1 hr. 25 min. | 2 hr. 5 min.  | 6 hr. 5 min.        |
| 32 GB Memory card/<br><b>HFR52</b> Built-in memory* | 2 hr. 30 min. | 2 hr. 55 min. | 4 hr. 10 min. | 12 hr.<br>15 min.** |
| 64 GB Memory card                                   | 5 hr. 5 min.  | 5 hr. 55 min. | 8 hr. 20 min. | 24 hr.<br>30 min.** |

For MP4 movies:

| Video quality and resolution →                      | 35 Mbps       | 24 Mbps       | 17 Mbps       | 4 Mbps              |
|-----------------------------------------------------|---------------|---------------|---------------|---------------------|
| Memory ↓                                            | (1920 x 1080) |               |               | (1280 x 1080)       |
| 8 GB Memory card/<br><b>HFR50</b> Built-in memory*  | 30 min.       | 40 min.       | 1 hr.         | 4 hr. 20 min.       |
| 16 GB Memory card                                   | 1 hr.         | 1 hr. 25 min. | 2 hr. 5 min.  | 8 hr. 40 min.       |
| 32 GB Memory card/<br><b>HFR52</b> Built-in memory* | 2 hr.         | 2 hr. 55 min. | 4 hr. 10 min. | 17 hr.<br>20 min.** |
| 64 GB Memory card                                   | 4 hr.         | 5 hr. 55 min. | 8 hr. 20 min. | 34 hr.<br>45 min.** |

\* **HFR52/R50** The built-in memory contains music files and image files (image mix frames), so the actual recording time may be shorter than the listed values.

\*\* A single scene can be recorded continuously for 12 hours; at that point, the camcorder will stop for about 3 seconds before resuming recording.

## Approximate number of photos that can be recorded on a 1 GB memory card

The actual number of photos that can be recorded will vary depending on the subject and shooting conditions.

| Photo size | Number of photos |
|------------|------------------|
| 1920x1080  | 660              |
| 1280x720*  | 1490             |

\* Photos recorded when the video format is set to MP4 and the video quality is set to 4 Mbps.

## Approximate charging times

The charging times given in the following table are approximate and vary according to charging conditions and initial charge of the battery pack.

| Battery pack→                    | BP-718   | BP-727   |
|----------------------------------|----------|----------|
| Charging conditions↓             |          |          |
| Using the camcorder              | 335 min. | 465 min. |
| Using the CG-700 Battery Charger | 220 min. | 315 min. |

## Approximate usage times with a fully charged battery pack

Recording and playback times given in the following tables are approximate and vary according to video quality and charging, recording or playback conditions. The effective usage time of the battery pack may decrease when recording in cold surroundings, when using the brighter screen settings, etc.

**HFR52/R50 Recording AVCHD movies using the built-in memory**

| Battery pack | Video quality | Recording (maximum) | Recording (typical)* | Playback |
|--------------|---------------|---------------------|----------------------|----------|
| BP-718       | 60P           | 100 min.            | 55 min.              | 160 min. |
|              | MXP           | 110 min.            | 65 min.              | 170 min. |
|              | FXP           | 110 min.            | 65 min.              | 175 min. |
|              | LP            | 110 min.            | 65 min.              | 175 min. |
| BP-727       | 60P           | 155 min.            | 90 min.              | 240 min. |
|              | MXP           | 165 min.            | 95 min.              | 260 min. |
|              | FXP           | 165 min.            | 95 min.              | 260 min. |
|              | LP            | 170 min.            | 95 min.              | 270 min. |

**Recording AVCHD movies using a memory card**

| Battery pack | Video quality | Recording (maximum) | Recording (typical)* | Playback |
|--------------|---------------|---------------------|----------------------|----------|
| BP-718       | 60P           | 95 min.             | 55 min.              | 160 min. |
|              | MXP           | 105 min.            | 60 min.              | 170 min. |
|              | FXP           | 105 min.            | 60 min.              | 170 min. |
|              | LP            | 110 min.            | 60 min.              | 175 min. |
| BP-727       | 60P           | 150 min.            | 85 min.              | 240 min. |
|              | MXP           | 165 min.            | 90 min.              | 260 min. |
|              | FXP           | 165 min.            | 95 min.              | 260 min. |
|              | LP            | 170 min.            | 95 min.              | 270 min. |

\* Approximate times for recording with repeated operations such as start/stop, zooming, and power on/off.

**HFR52/R50 Recording MP4 movies using the built-in memory**

| Battery pack | Video quality | Recording (maximum) | Recording (typical)* | Playback |
|--------------|---------------|---------------------|----------------------|----------|
| BP-718       | 35 Mbps       | 100 min.            | 55 min.              | 160 min. |
|              | 24 Mbps       | 120 min.            | 65 min.              | 175 min. |
|              | 17 Mbps       | 120 min.            | 65 min.              | 175 min. |
|              | 4 Mbps        | 125 min.            | 70 min.              | 185 min. |
| BP-727       | 35 Mbps       | 150 min.            | 90 min.              | 245 min. |
|              | 24 Mbps       | 180 min.            | 100 min.             | 265 min. |
|              | 17 Mbps       | 180 min.            | 100 min.             | 265 min. |
|              | 4 Mbps        | 195 min.            | 110 min.             | 285 min. |

**Recording MP4 movies using a memory card**

| Battery pack | Video quality | Recording (maximum) | Recording (typical)* | Playback |
|--------------|---------------|---------------------|----------------------|----------|
| BP-718       | 35 Mbps       | 95 min.             | 60 min.              | 160 min. |
|              | 24 Mbps       | 115 min.            | 65 min.              | 175 min. |
|              | 17 Mbps       | 115 min.            | 65 min.              | 175 min. |
|              | 4 Mbps        | 125 min.            | 70 min.              | 185 min. |
| BP-727       | 35 Mbps       | 150 min.            | 85 min.              | 240 min. |
|              | 24 Mbps       | 175 min.            | 100 min.             | 265 min. |
|              | 17 Mbps       | 180 min.            | 100 min.             | 265 min. |
|              | 4 Mbps        | 190 min.            | 105 min.             | 285 min. |

\* Approximate times for recording with repeated operations such as start/stop, zooming, and power on/off.

## Downloading Music Files and Image Files (Image Mix Frames)

Canon offers for download music files for use as background music and image files (image mix frames) for the image mix function. Access the following Web site, click on your country/region and follow the onscreen instructions to download the files.

<http://www.canon.com/icpd/>

### About the music files

The specifications of the music files compatible with the camcorder are as follows.

**Audio encoding:** Linear PCM

**Audio sampling:** 48 kHz, 16 bits, 2 channels

**Minimum length:** 1 second

**File type:** WAV

- **HF R52/R50** 3 music files come pre-installed in the built-in memory under the following folder.

**CANON\MY\_MUSIC\**

- To play back recordings from a memory card with background music, use **Transfer Utility LE** to transfer the music files from your computer to the following folder on the memory card that contains the recordings.

**CANON\PRIVATE\MY\_MUSIC\**

- The camcorder can recognize music files named MUSIC\_01.WAV to MUSIC\_99.WAV.

### About the image files for the Image Mix function

The specifications of image files that can be used with the image mix function are as follows.

**Image size:** 1920 x 1080 pixels

**File type:** Baseline JPEG

**Color sampling:** 4:2:2 or 4:2:0

- **HF R52/R50** Image files come pre-installed in the built-in memory under the following folders.

Image mix frames that can be used only in  mode:

**CANON\MY\_PICT\BABY\**







Image mix frames that can be used only in other modes:

**CANON\MY\_PICT\**



- To use the image mix function while recording on a memory card, copy the image files from your computer to the following folders on the memory card, depending on the shooting mode you wish to use.  
Image mix frames that can be used only in  mode:  
**CANON\PRIVATE\MY\_PICT\BABY\**  
Image mix frames that can be used only in other modes:  
**CANON\PRIVATE\MY\_PICT\**
- The camcorder can recognize image files named MIX\_01.JPG to MIX\_99.JPG.

## To copy image files directly onto the camcorder

- 1 Power the camcorder using the compact power adapter.**
- 2 Press  to set the camcorder to playback mode and open the  index screen for AVCHD movies ( 46).**
- 3 Connect the camcorder to the computer using the supplied USB cable.**  
Connection -. Refer to *Connection Diagrams* ( 100).
- 4 Camcorder: Select [All (for PC only)].**
  - When the connection is successfully established, [USB Connection] will appear on the camcorder's screen.
  - One or two new drives labeled "CANON" will appear on the computer: one for the built-in memory ( only) and one for the memory card in the camcorder.
- 5 Computer: Copy the image files to one of the folders mentioned above, as necessary.**

When you have finished, be sure to use the computer's Safely Remove Hardware function to end the connection before disconnecting the USB cable and turning off the camcorder.

# Index

60P recording ..... 56

## A

Abroad, using the camcorder ..... 180  
Aspect ratio of a connected  
  TV (TV type) ..... 150  
Audio recording level ..... 144  
Audio scene select ..... 81  
AUTO mode ..... 41  
Auto slow shutter ..... 147  
Automatic backlight correction . . . 147  
AV OUT/ $\phi$  terminal ..... 82, 98, 100

## B

Baby (shooting mode) ..... 60  
Baby album ..... 46  
Background music ..... 87  
Battery pack  
  Battery information ..... 153, 158  
  Charging ..... 20  
  Remaining charge indicator  
    ..... 158  
Beach (Special Scene mode) ..... 63  
Built-in backup battery ..... 178

## C

CameraAccess plus\* ..... 120  
CANON IMAGE GATEWAY\*  
  ..... 116, 128  
Capturing photos/video snapshot  
  scenes from a movie ..... 85  
Changing a scene's thumbnail  
  image ..... 93  
Chroma key ..... 70  
Cinema (shooting mode) ..... 61  
Cinema-look filters ..... 61  
Condensation ..... 179  
Connections to external devices  
  ..... 99  
Converting/Resizing movies\* ..... 103

Copying recordings to a memory  
  card\* ..... 95

## D

Date and time ..... 26  
Decoration ..... 65  
Deleting recordings ..... 53  
Dividing scenes ..... 91  
Dual recording ..... 58

## E

Edit panel ..... 145  
Error messages ..... 165  
Exposure ..... 75  
External microphone ..... 83

## F

Face detection ..... 72  
Facebook ..... 116, 126, 128  
Faders ..... 74  
File numbering ..... 153  
Fireworks (Special Scene mode)  
  ..... 64  
Flicker reduction ..... 148  
Focus ..... 76  
Folder name ..... 153  
Frame rate ..... 79

## H

HDMI OUT terminal ..... 98, 99  
Headphones ..... 82  
Home menu ..... 32, 141

## I

Image mix ..... 69  
Image mix frames (download) . . . 192  
Image stabilizer ..... 148  
ImageBrowser EX (download) . . . 107  
Initializing the memory ..... 29  
Intelligent IS ..... 43

\* HFR52/R50 only.

|                                               |         |                                                                        |     |
|-----------------------------------------------|---------|------------------------------------------------------------------------|-----|
| <b>L</b>                                      |         | Reference tables (charging, usage,<br>recording times, etc.) . . . . . | 188 |
| LCD screen brightness . . . . .               | 149     | Relay recording* . . . . .                                             | 58  |
| LCD touch screen . . . . .                    | 31      | Remote Browse* . . . . .                                               | 125 |
| Low light (Special Scene mode) . . .          | 63      | Remote Control+Streaming* . . . .                                      | 120 |
| <b>M</b>                                      |         | Resetting all camcorder settings<br>. . . . .                          | 154 |
| Main Functions panel . . . . .                | 142     | <b>S</b>                                                               |     |
| Maintenance . . . . .                         | 179     | Saving recordings . . . . .                                            | 103 |
| Markers . . . . .                             | 149     | Transferring to a computer<br>. . . . .                                | 105 |
| Memory card . . . . .                         | 23, 177 | Using external<br>video recorders . . . . .                            | 114 |
| Memory save* . . . . .                        | 110     | Scene (shooting mode) . . . . .                                        | 62  |
| MIC terminal . . . . .                        | 83, 84  | SCN (Special Scene<br>shooting mode) . . . . .                         | 62  |
| Monitor from Home* . . . . .                  | 120     | Selecting the memory*<br>for playback . . . . .                        | 46  |
| Monitor while Out* . . . . .                  | 121     | for recording . . . . .                                                | 58  |
| Movie format (AVCHD/MP4) . . . . .            | 56      | Self timer . . . . .                                                   | 146 |
| Movie Uploader* . . . . .                     | 126     | Serial number . . . . .                                                | 18  |
| Music files (download) . . . . .              | 192     | Shooting mode . . . . .                                                | 59  |
| <b>N</b>                                      |         | Shooting mode button . . . . .                                         | 59  |
| Night scene<br>(Special Scene mode) . . . . . | 63      | Slideshow . . . . .                                                    | 94  |
| Notification sounds . . . . .                 | 153     | Smart AUTO . . . . .                                                   | 42  |
| <b>O</b>                                      |         | Snow (Special Scene mode) . . . . .                                    | 63  |
| Onscreen icons . . . . .                      | 155     | Sports (Special Scene mode) . . . .                                    | 63  |
| Other Settings menus . . . . .                | 35, 146 | Spotlight (Special Scene mode) . . .                                   | 64  |
| <b>P</b>                                      |         | Sunset (Special Scene mode) . . . .                                    | 63  |
| P (Programmed AE<br>shooting mode) . . . . .  | 64      | <b>T</b>                                                               |     |
| Playback                                      |         | Tele macro . . . . .                                                   | 80  |
| Movies . . . . .                              | 46      | Telephoto . . . . .                                                    | 43  |
| Photos . . . . .                              | 50      | Time zone/DST . . . . .                                                | 28  |
| Portrait (Special Scene mode) . . . .         | 63      | Timeline . . . . .                                                     | 89  |
| Power saving . . . . .                        | 39      | Touch AE . . . . .                                                     | 76  |
| Powered IS . . . . .                          | 143     | Touch AF . . . . .                                                     | 77  |
| Pre-recording . . . . .                       | 144     | Touch screen operations . . . . .                                      | 31  |
| <b>R</b>                                      |         | Transfer Utility LE (download) . . .                                   | 105 |
| Recording                                     |         | Trimming scenes . . . . .                                              | 92  |
| Movies . . . . .                              | 37      | Tripod . . . . .                                                       | 176 |
| Photos . . . . .                              | 40      | Troubleshooting . . . . .                                              | 159 |
| Recording time . . . . .                      | 188     |                                                                        |     |

\* **HFR52/R50** only.

Turning off notification sounds . . . 153

## U

Uploading recordings to  
the Web . . . . . 116, 126, 128

USB terminal . . . . . 98, 100

## V

Video quality . . . . . 56

Video snapshot . . . . . 71

Volume . . . . . 49

## W

White balance . . . . . 78

Wide angle . . . . . 43

Wi-Fi functions\* . . . . . 117

## Y

YouTube . . . . . 116, 126, 128

## Z

Zoom . . . . . 43

Advanced zoom . . . . . 143

Zoom speed . . . . . 147

Zoom type . . . . . 143

\* **HFR52/R50** only.

## CANON CONSUMER DIGITAL VIDEO EQUIPMENT LIMITED WARRANTY FOR THE UNITED STATES

The limited warranty set forth below is given by Canon U.S.A., Inc. ("Canon USA") with respect to Canon Consumer Digital Video Equipment (the "Equipment") purchased in the United States. This limited warranty is only effective upon presentation of your Bill of Sale or other proof of purchase.

The Equipment is warranted under normal, non-commercial, personal use, against defective materials or workmanship as follows:

**Parts:** Defective parts will be exchanged for new parts or comparable rebuilt parts for a period of ONE YEAR from the date of original purchase, except for a defective Video Head, which will be exchanged for a period of three months from the date of purchase.

**Labor:** For a period of ONE YEAR from the date of original purchase, labor will be provided free of charge by our factory service centers or designated service facilities located in the United States.

When returning Equipment under this warranty, you must pre-pay the shipping charges, and you must enclose the Bill of Sale or other proof of purchase with a complete explanation of the problem. During the ONE-YEAR warranty period, repairs will be made and the Equipment will be return-shipped to you free of charge. For repairs after the warranty period is over, you will be given an estimate of the cost of repair and an opportunity to approve or disapprove of the repair expense before it is incurred. If you approve, repairs will be made and the Equipment will be return-shipped to you. (shipping charges apply). If you disapprove, we will return-ship the equipment at no charge to you.

**Non-Canon brand peripheral equipment and software which may be distributed with, or factory loaded on, the Equipment, are sold "AS IS" without warranty of any kind by Canon USA, including any implied warranty regarding merchantability or fitness for a particular purpose. The sole warranty with respect to such non-Canon brand items is given by the manufacturer or producer thereof. If the Equipment contains a hard disk drive, Canon USA recommends that data stored on that drive be duplicated or backed up to prevent its loss in the event of failure or other malfunction of such drive.**

Canon USA shall have no responsibility under this limited warranty for use of the Equipment in conjunction with incompatible peripheral equipment and incompatible software.

In order to obtain warranty service, contact the authorized Canon retail dealer from whom you purchased the Equipment or call the CANON INFORMATION CENTER AT 1-800-OK-CANON). You will be directed to the nearest service facility for your Equipment.

This Limited Warranty covers all defects encountered in normal use of the Equipment and does not apply in the following cases:

- A) Loss or damage to the Equipment due to abuse, mishandling, accident, improper maintenance, or failure to follow operating instructions;
- B) If the Equipment is defective as a result of leaking batteries, sand, dirt or water damage;
- C) If defects or damages are caused by the use of unauthorized parts or by service other than by Canon USA's factory service centers or authorized service facilities;
- D) If the Equipment is used for commercial or industrial use.

This Limited Warranty does not cover cabinet (exterior finish), video cassette tape, head cleanings, nor does it apply to Equipment purchased outside the United States. This warranty does not cover units sold to rental firms, military operations, hotels, schools, hospitals or for other commercial, industrial, or institutional applications.

These uses are covered only by such specific warranty as Canon may issue with such sales.

This Limited Warranty does not apply to accessories or consumables for the Equipment, which are sold "AS IS", without warranty of any kind by Canon USA.

Please retain this warranty card and your Bill of Sale as a permanent record of your purchase. This card is most important in order to be sure you are contacted right away should there be a safety inspection, modification or product recall under applicable laws or regulations.

**NO IMPLIED WARRANTY, INCLUDING MERCHANTABILITY AND FITNESS FOR A PARTICULAR PURPOSE APPLIES TO THIS EQUIPMENT AFTER THE APPLICABLE PERIOD OF EXPRESS WARRANTY OR GUARANTY, EXCEPT AS MENTIONED ABOVE, GIVEN BY ANY PERSON, FIRM OR CORPORATION WITH RESPECT TO THIS EQUIPMENT SHALL BIND THE UNDERSIGNED (SOME STATES DO NOT ALLOW LIMITATIONS ON HOW LONG AN IMPLIED WARRANTY LASTS, SO THE ABOVE LIMITATION OR EXCLUSION MAY NOT APPLY TO YOU). CANON USA SHALL NOT BE LIABLE FOR LOSS OF REVENUES OR PROFITS, EXPENSE FOR SUBSTITUTE EQUIPMENT OR SERVICE, STORAGE CHARGES,**

LOSS OR CORRUPTION OF DATA, INCLUDING WITHOUT LIMITATION, LOSS OR CORRUPTION OF DATA STORED ON THE EQUIPMENT'S HARD DRIVE, OR ANY OTHER SPECIAL, INCIDENTAL OR CONSEQUENTIAL DAMAGES CAUSED BY THE USE, MISUSE OR INABILITY TO USE THE EQUIPMENT, REGARDLESS OF THE LEGAL THEORY ON WHICH THE CLAIM IS BASED, AND EVEN IF CANON USA HAS BEEN ADVISED OF THE POSSIBILITY OF SUCH DAMAGES. NOR SHALL RECOVERY OF ANY KIND AGAINST CANON USA BE GREATER THAN THE PURCHASE PRICE OF THE EQUIPMENT SOLD BY CANON USA AND CAUSING THE ALLEGED DAMAGE. WITHOUT LIMITING THE FOREGOING, YOU ASSUME ALL RISK AND LIABILITY FOR LOSS, DAMAGE OR INJURY TO YOU AND YOUR PROPERTY AND TO OTHERS AND THEIR PROPERTY ARISING OUT OF USE, MISUSE OR INABILITY TO USE THE EQUIPMENT NOT CAUSED DIRECTLY BY THE NEGLIGENCE OF CANON USA. (SOME STATES DO NOT ALLOW THE EXCLUSION OR LIMITATION OF INCIDENTAL OR CONSEQUENTIAL DAMAGES, SO THE ABOVE LIMITATION MAY NOT APPLY TO YOU). THIS WARRANTY SHALL NOT EXTEND TO ANYONE OTHER THAN THE ORIGINAL PURCHASER OF THIS EQUIPMENT OR THE PERSON FOR WHOM IT WAS PURCHASED AS A GIFT.

This warranty gives you specific legal rights, and you may also have other rights which vary from state to state. CANON U.S.A., INC.

**CANON CONSUMER DIGITAL VIDEO EQUIPMENT LIMITED WARRANTY**

The limited warranty set forth below is given by Canon Canada Inc. ("Canon Canada") with respect to Canon Consumer Digital Video Equipment (the "Equipment") purchased in Canada. This limited warranty is only effective upon presentation of a bill of sale or other proof of purchase for this Equipment to a Canon Service Facility when repairs are required. The Equipment is warranted under normal, non-commercial, personal use, against defective materials or workmanship as follows:

**Parts:** Defective parts will be exchanged for new parts or, at Canon Canada's option, comparable rebuilt parts for a period of one year from the date of original purchase, except Video Heads which will be exchanged for a period of 3 months from the date of purchase.

**Labour:** For a period of one year from the date of original purchase, labour will be provided free of charge by our Canon Service Facilities in Canada.

This limited warranty covers all defects except where:

(a) The loss or damage to the product results from:

- i) accident, natural disaster, mishandling, abuse, neglect, unauthorized product modification or failure to follow instructions contained in the instruction manual;
- ii) the use of accessories, attachments, products, supplies, parts or devices with the Equipment that do not conform to Canon specifications or that cause abnormally frequent service problems;
- iii) repairs or services performed by any party other than a Canon Service Facility;
- iv) defective batteries or any exposure to water, sand or dirt;
- v) shipping (claim must be presented to the shipper);

(b) Any serial number on the video equipment is altered or removed.

(c) The Equipment is used for commercial, professional or industrial purposes.

This limited warranty does not cover the cabinet (exterior finish) of the Equipment, media, nor does it apply to Equipment purchased outside Canada.

If the Equipment contains a hard disk drive, Canon Canada recommends that data stored on that drive be duplicated or backed up to prevent its loss in the event of a failure or other malfunction of such drive.

**TO OBTAIN WARRANTY SERVICE**

Ship your Equipment in its original carton, box or equivalent, properly packed, fully insured with shipping charges prepaid, together with a copy of your bill of sale or other proof of purchase and a description of the problem to any of the Canon Service Facilities in Canada.

**LIMITATIONS**

Except as otherwise required by applicable legislation, this warranty is in lieu of all other warranties, conditions, guarantees or representations, express or implied, statutory or otherwise, relative to the Equipment, including implied warranties or conditions of merchantability or fitness for a particular purpose.

Canon Canada assumes no liability for special, consequential or incidental damages, loss or corruption of data including, without limitation, data stored on the hard disk drive of the Equipment or loss that may arise, whether on account of negligence or otherwise, from the use, misuse or inability to use the Equipment (including loss of profit, revenue, media or enjoyment) or from failure to conform to any express or implied warranties, conditions, guarantees or representations. Any recovery under this limited warranty shall not exceed the purchase price of the equipment. Canon Canada does not assume or authorize any other person to assume for Canon Canada any other liability with respect to this equipment.

This warranty does not extend to any person other than the original purchaser of the Equipment or the person for whom it was purchased as a gift and states your exclusive remedy.

**NOTICE TO CONSUMER**

If you plan to take important videos or if the product has not been used for some time, please check all functions with the instruction book before using it.

# Canon

---

## USA

### CANON U.S.A., INC. NEW JERSEY OFFICE

100 Jamesburg Road, Jamesburg, NJ 08831 USA

### CANON U.S.A., INC. CHICAGO OFFICE

100 Park Blvd., Itasca, IL 60143 USA

### CANON U.S.A., INC. LOS ANGELES OFFICE

15955 Alton Parkway, Irvine, CA 92618 USA

### CANON U.S.A., INC. HONOLULU OFFICE

210 Ward Avenue, Suite 200, Honolulu, HI 96814 USA

- ❖ If you have any questions, call the Canon U.S.A. Information Center toll-free at 1-800-828-4040 (USA only).
- 

## CANADA

### CANON CANADA INC.

6390 Dixie Road, Mississauga, ON L5T 1P7

- ❖ If you have any questions, call the Canon Canada Information Center toll free (in Canada only) at 1-800-OK-CANON (1-800-652-2666).
  - ❖ Si vous avez des questions, veuillez téléphoner 1-800-OK-CANON (1-800-652-2666, sans frais au Canada seulement).
- 

## MÉXICO

### CANON MEXICANA, S DE RL DE CV

Blvd. Manuel Ávila Camacho No. 138, Piso 17

Col. Lomas de Chapultepec, C.P. 11000 México, D.F., México

### CANON U.S.A., INC. NEW JERSEY OFFICE

100 Jamesburg Road, Jamesburg, NJ 08831 USA

---

## CENTRO Y SURAMÉRICA

### CANON LATIN AMERICA, INC.

One Canon Park Melville, NY 11747, USA

---

## ASIA

### CANON HONGKONG COMPANY LTD.

19/F, The Metropolis Tower, 10 Metropolis Drive,

Hunghom, Kowloon, Hong Kong

Tel: +852 3191 2333, Fax: +852 2428 3963

---

For support concerning PIXELA's software, please call PIXELA customer support (see the back cover of the Startup Guide for PIXELA's software).