

Printer Adapter (Sheet 1 of 1)

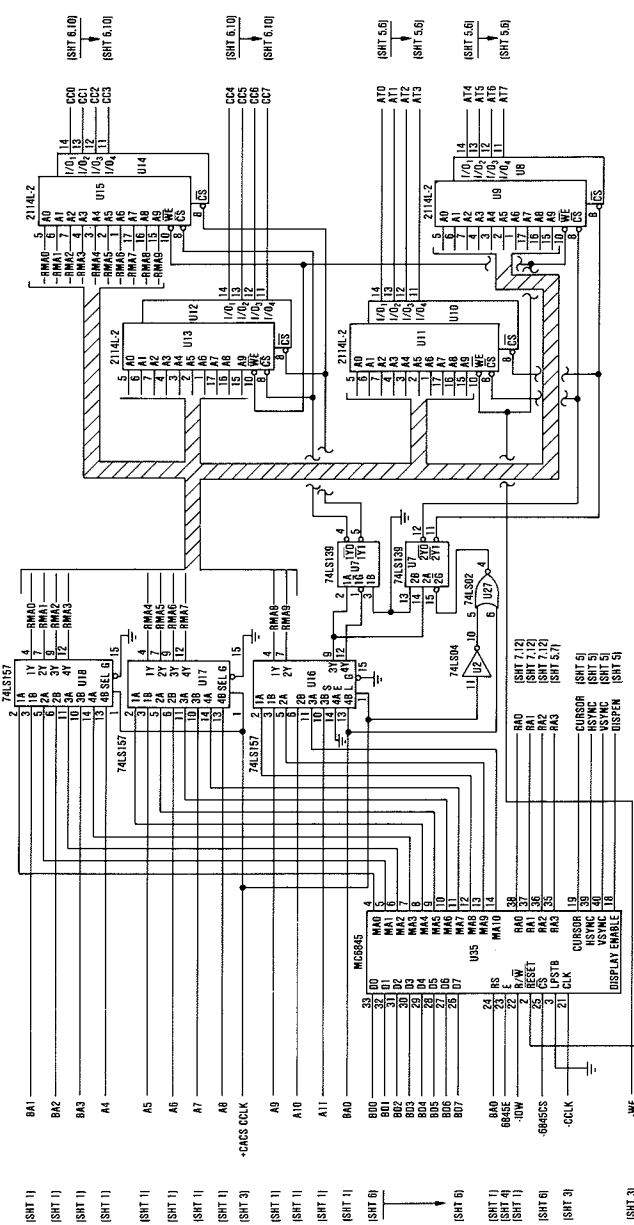

Monochrome Display Adapter (Sheet 2 of 10)

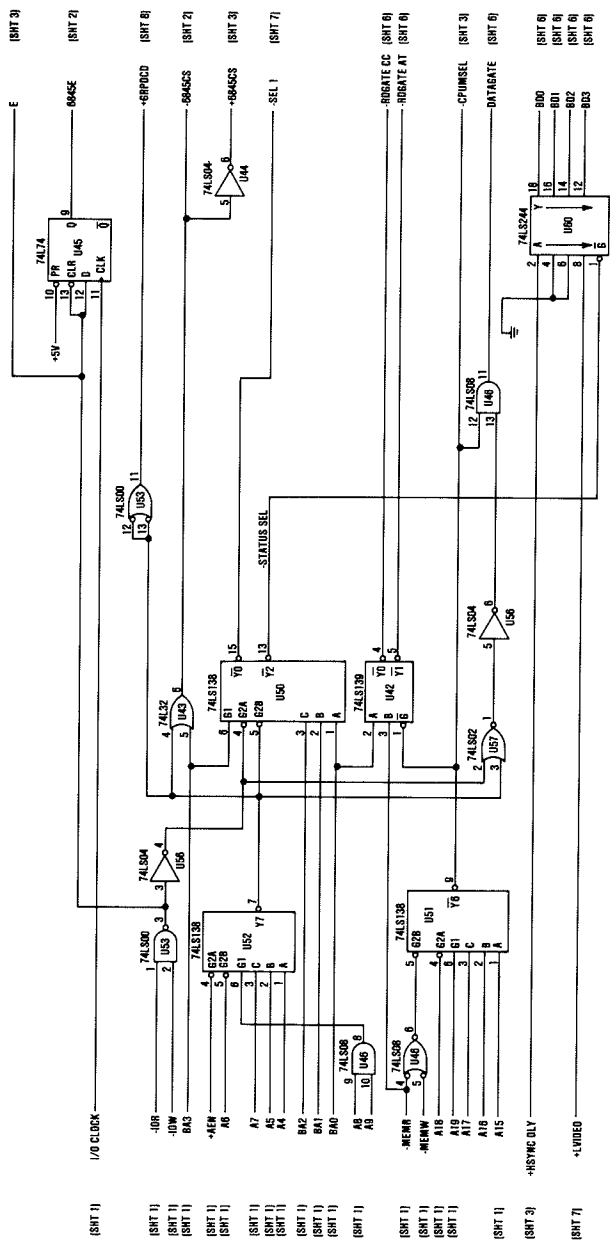

Monochrome Display Adapter (Sheet 4 of 10)

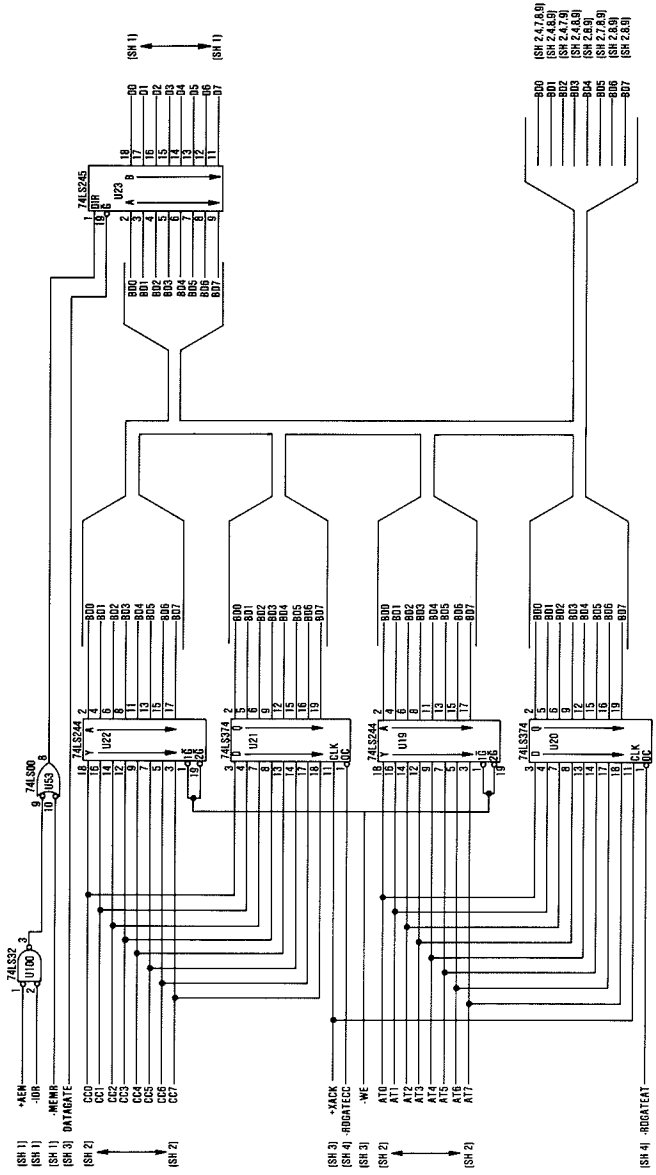

Monochrome Display Adapter (Sheet 6 of 10)

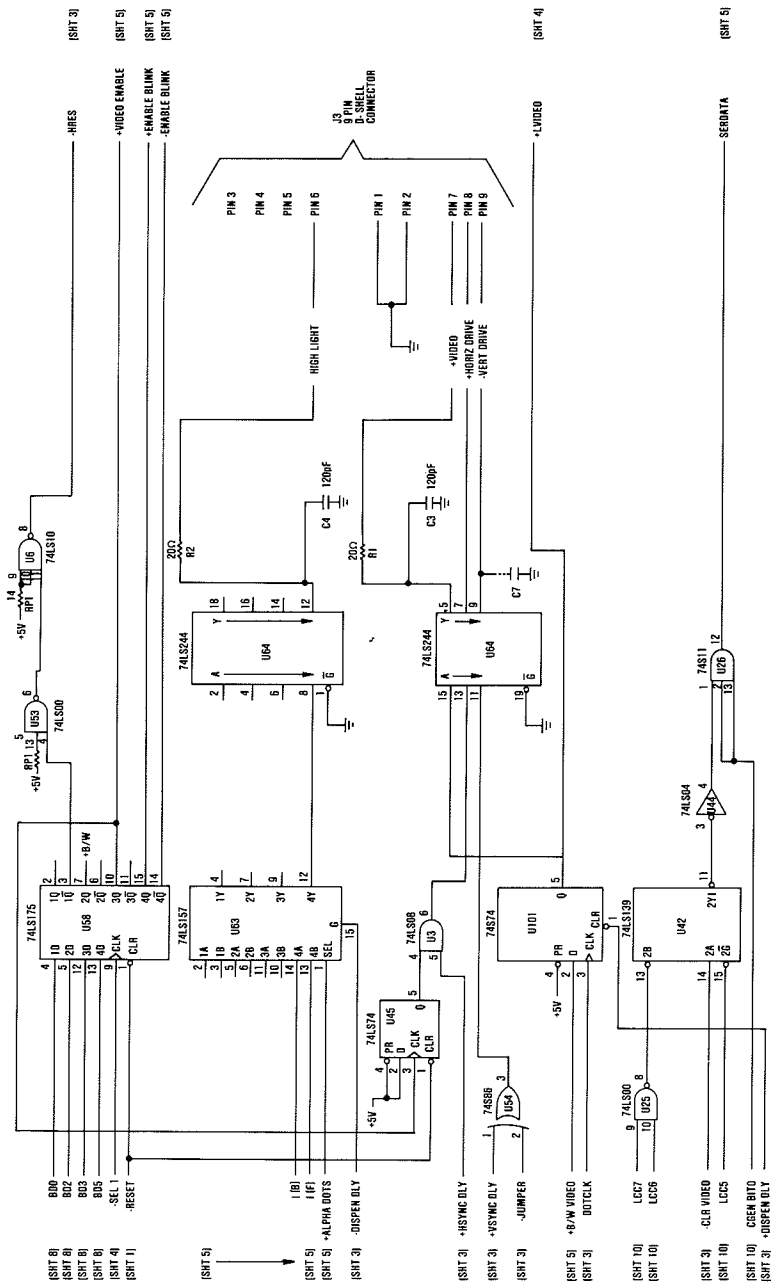

Monochrome Display Adapter (Sheet 7 of 10)

(SHT 5)

(SHT 4)

(SHT 5)

(SHT 5)

(SHT 5)

(SHT 5)

(SHT 5)

(SHT 5)

(SHT 5)

(SHT 5)

(SHT 5)

(SHT 5)

(SHT 5)

(SHT 5)

(SHT 5)

(SHT 5)

(SHT 5)

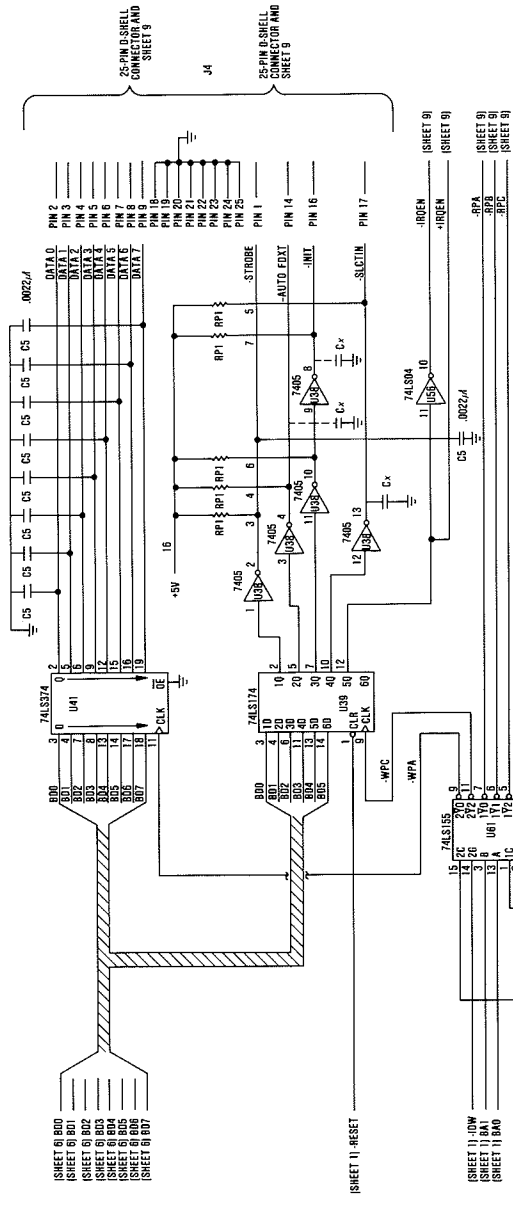

Monochrome Display Adapter (Sheet 8 of 10)

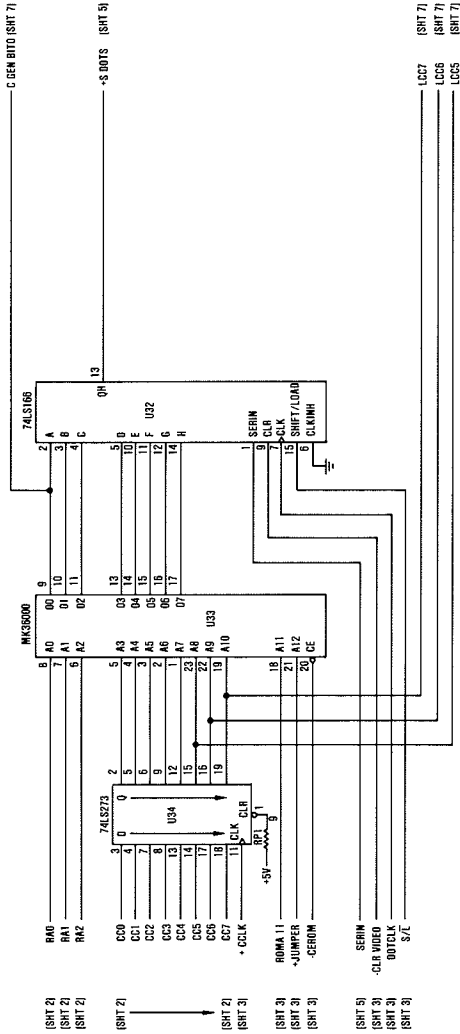

Monochrome Display Adapter (Sheet 10 of 10)

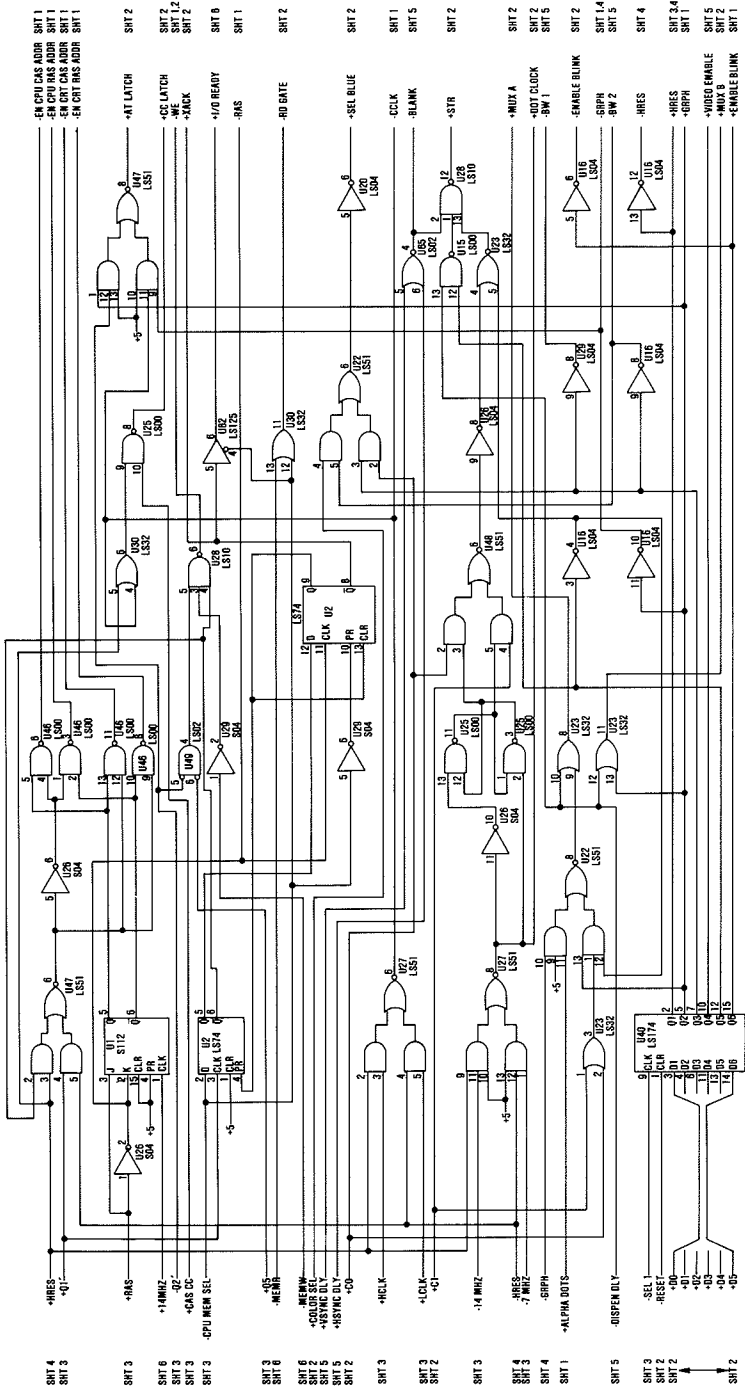

Color/Graphics Monitor Adapter (Sheet 4 of 6)

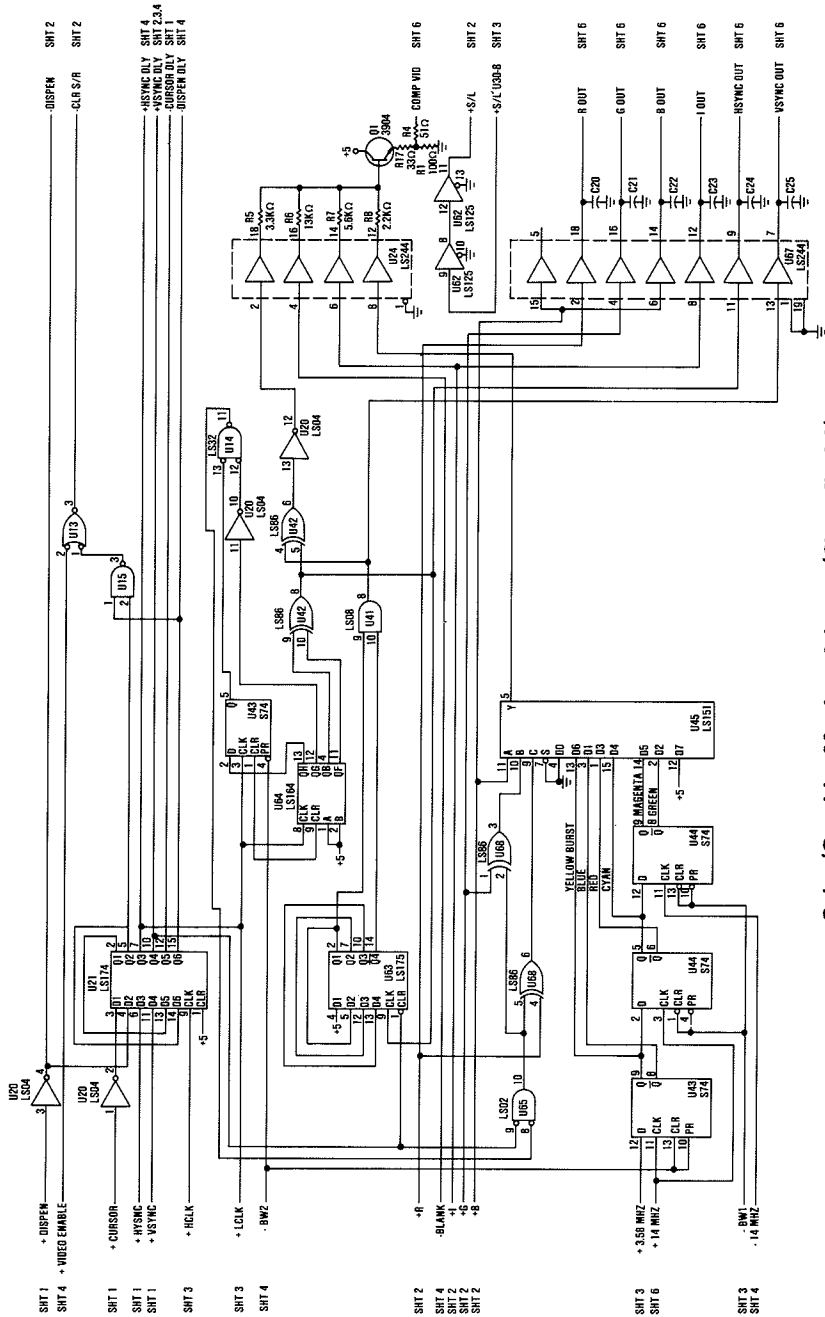

Color/Graphics Monitor Adapter (Sheet 5 of 6)

DANGER

**HAZARDOUS VOLTAGES
UP TO 450 VOLTS EXIST
ON THE PRINTED
CIRCUIT BOARDS**

NOTES:

1. RESISTOR VALUES ARE IN OHMS K = 1000 OHMS.
2. ALL RESISTORS ARE 1/2 WATT EXCEPT WHERE OTHERWISE INDICATED.
3. CAPACITOR VALUES ARE IN μ F UNLESS OTHERWISE INDICATED P = PF.
4. ALL CAPACITORS ARE 50 VOLTS UNLESS OTHERWISE INDICATED.

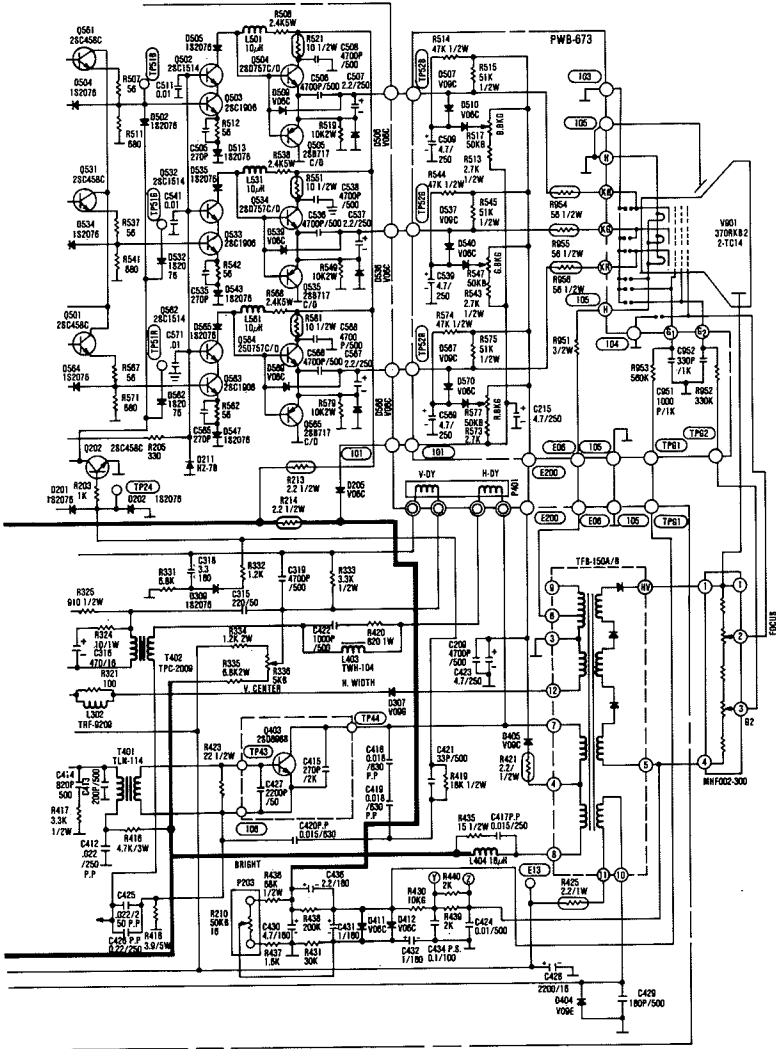

**DANGER
 HAZARDOUS VOLTAGES
 UP TO 450 VOLTS EXIST
 ON THE PRINTED
 CIRCUIT BOARDS**

- NOTES:**
1. RESISTOR VALUES ARE IN OHMS (Ω), K (K), 1000 Ω, M (M), 1,000,000 Ω.
 2. ALL RESISTORS ARE 1/4W EXCEPT WHERE OTHERWISE INDICATED.
 3. ALL CAPACITORS ARE 50V EXCEPT WHERE OTHERWISE INDICATED.
 4. ALL DIMENSIONS ARE IN INCHES UNLESS OTHERWISE INDICATED.
 5. AC WIRING INFORMATION
 6. PHASE - BLACK/BROWN WIRE
 7. GROUND - GREEN AND YELLOW WIRE
- IMPORTANT: THE PHASE WIRE MUST GO TO THE FUSED SIDE OF TRANSFORMER**

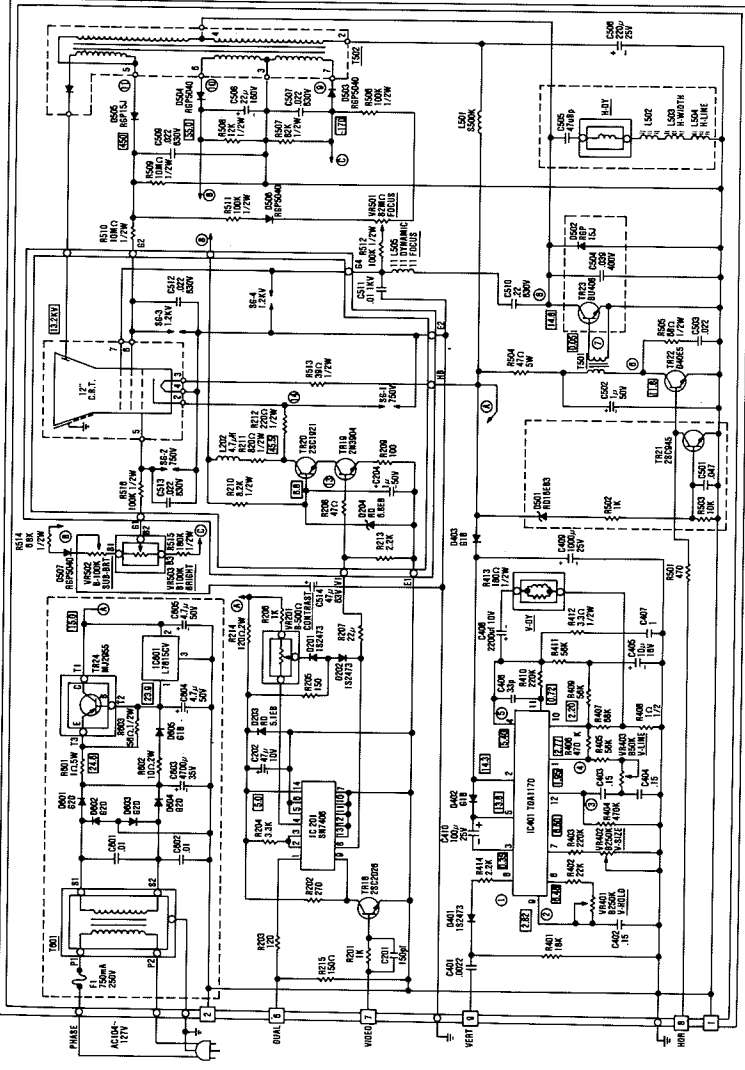

Monochrome Display (Sheet 1 of 1)

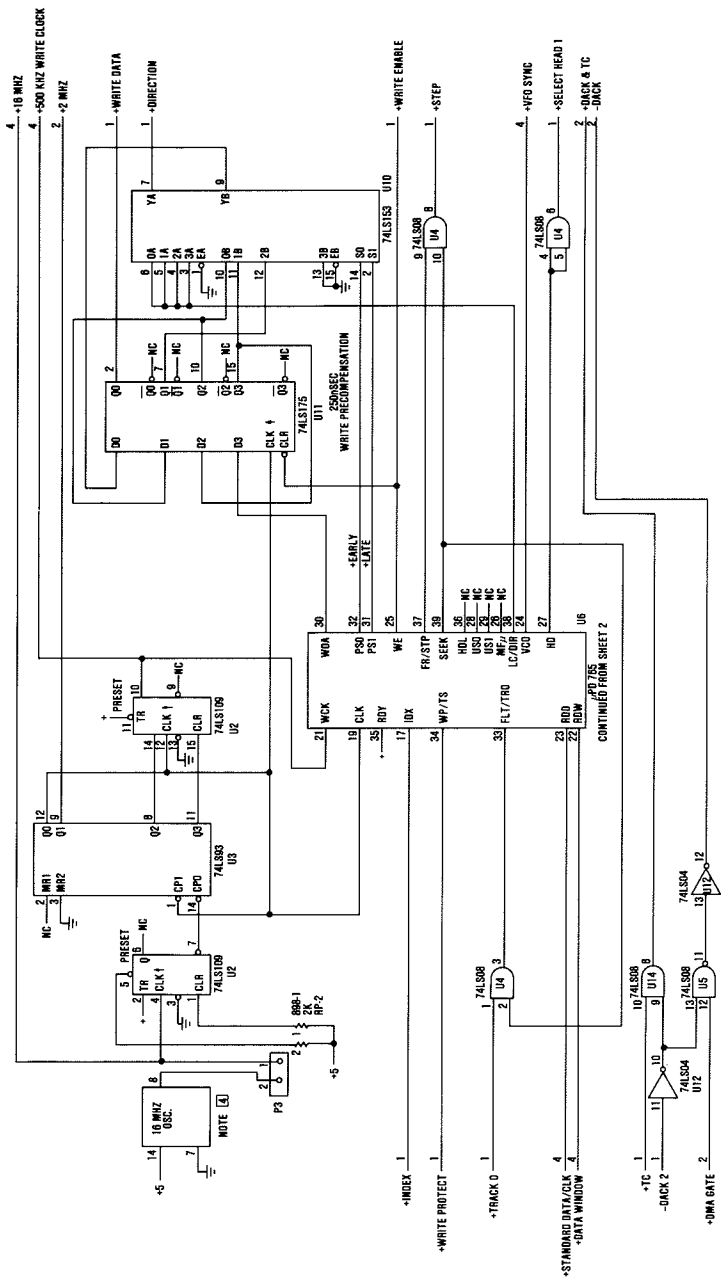

NOTE:
 U2, 74LS109, UMS 12 AND 13 ARE CONNECTED ONLY ON CARDS BUILT
 USING RAW CARD PTA 508255

5-1/4 Inch Diskette Drive Adapter (Sheet 3 of 4)

CONTINUED FROM SHEET 2

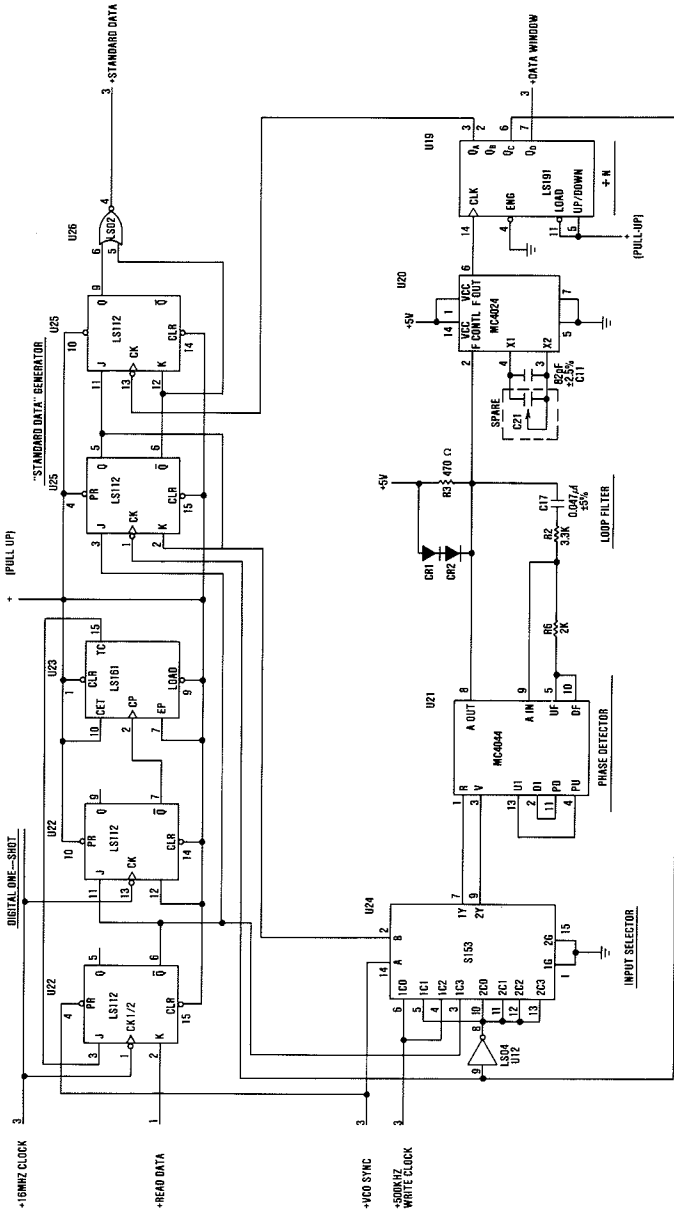

5-1/4 Inch Diskette Drive Adapter (Sheet 4 of 4)

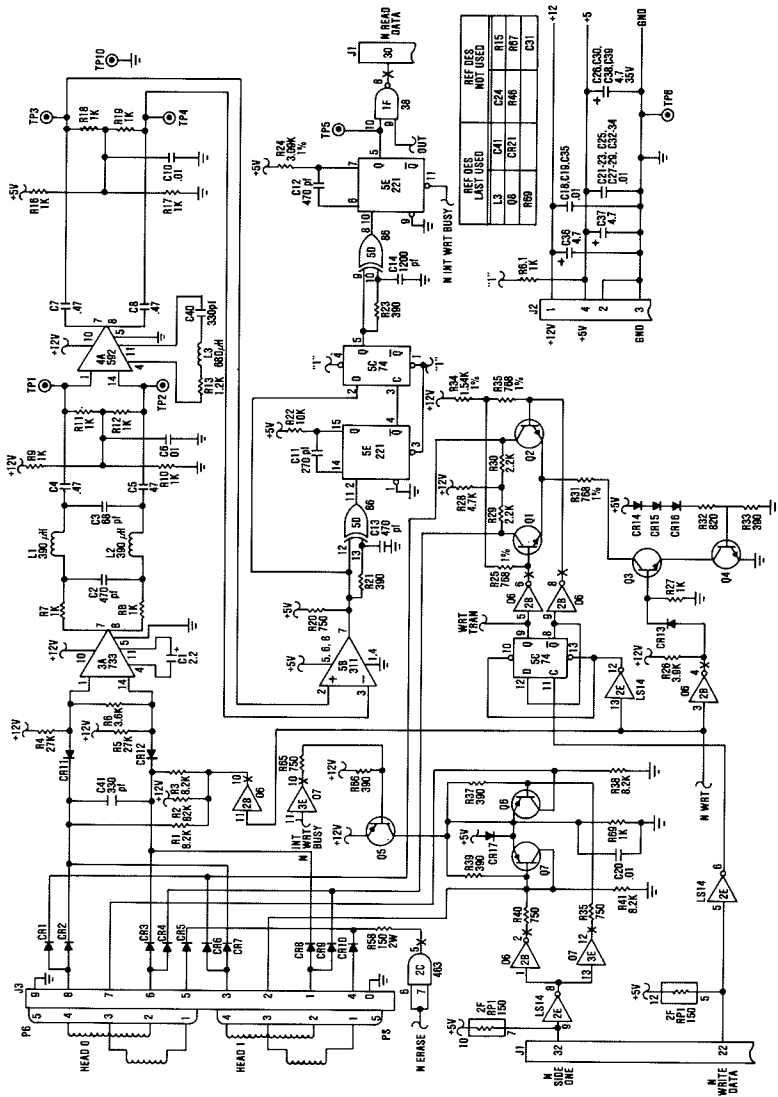

5-1/4 Inch Diskette Drive Type 1 (Sheet 1 of 3)

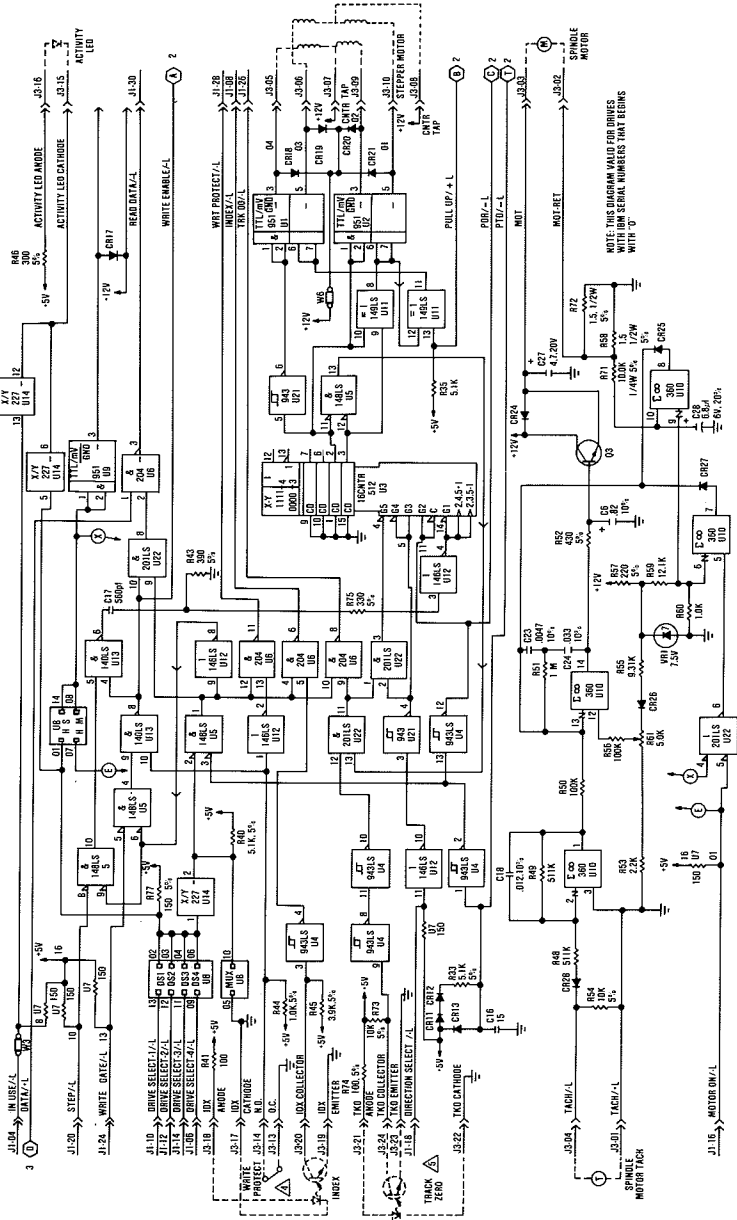

5-1/4 Inch Diskette Drive Type 2 (Sheet 1 of 2)

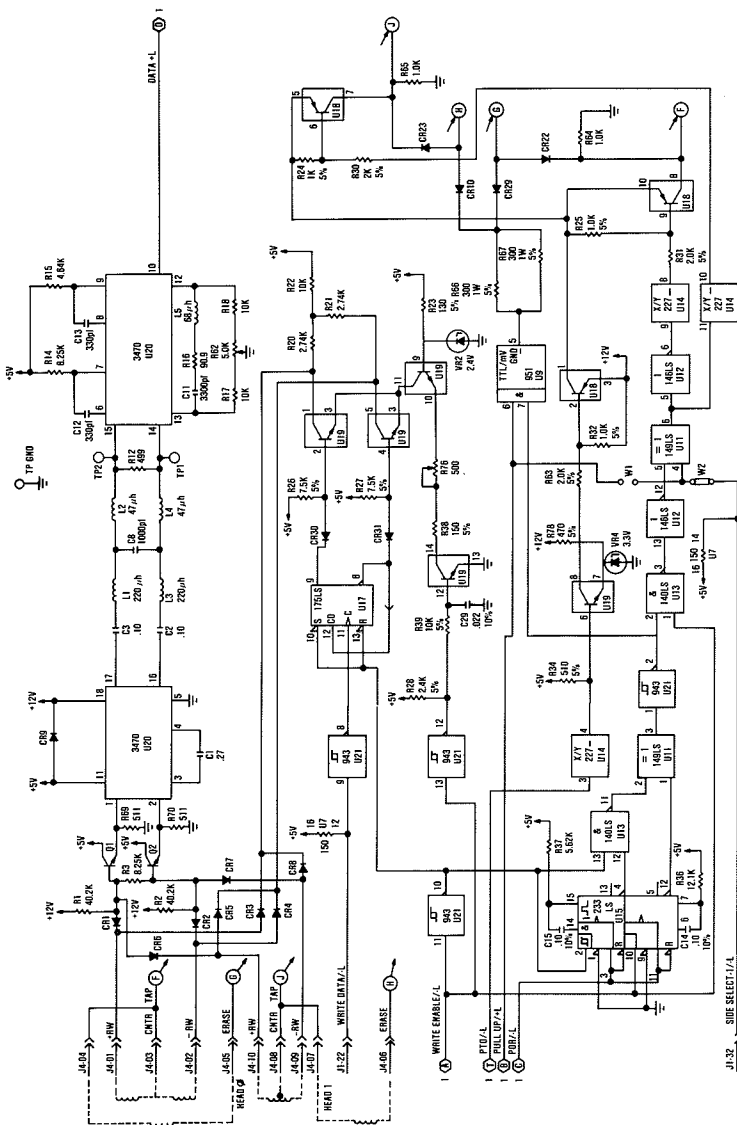

5-1/4 Inch Diskette Drive Type 2 (Sheet 2 of 2)

J1-32, SIDE SELECT 1/1

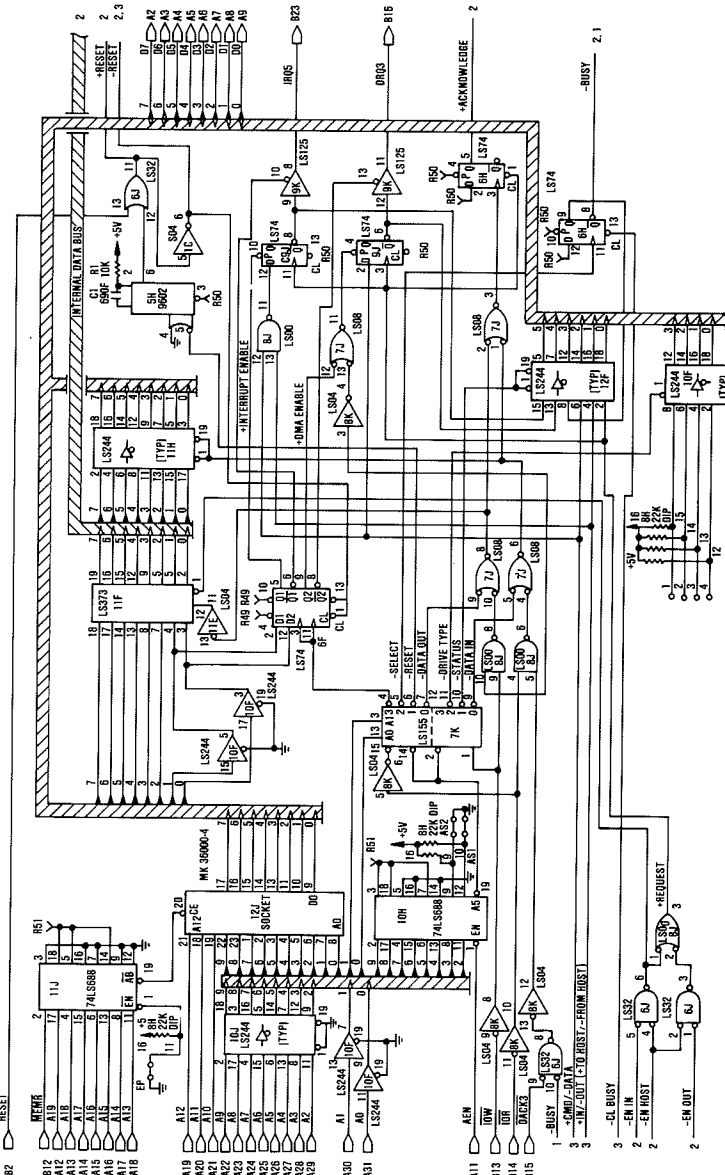

Fixed Disk Drive Adapter (Sheet 1 of 6)

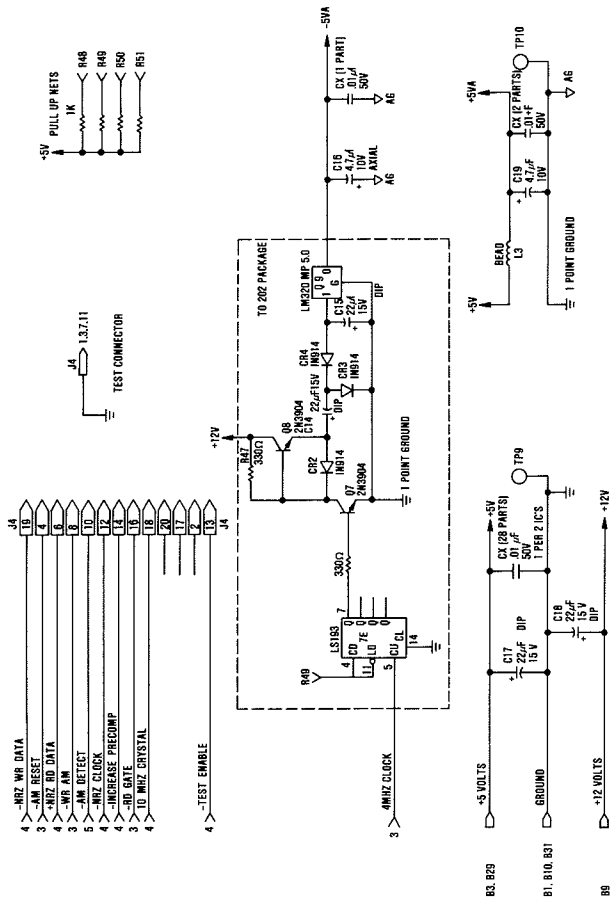

NOTES:
 1. UNLESS OTHERWISE SPECIFIED,
 ALL CAPS - 10% OR GREATER +10%.
 2. ALL CAPS - 10% OR GREATER +10%.
 3. NO MORE THAN 15 LOCUS PER PULLUP NET.

Fixed Disk Drive Adapter (Sheet 6 of 6)

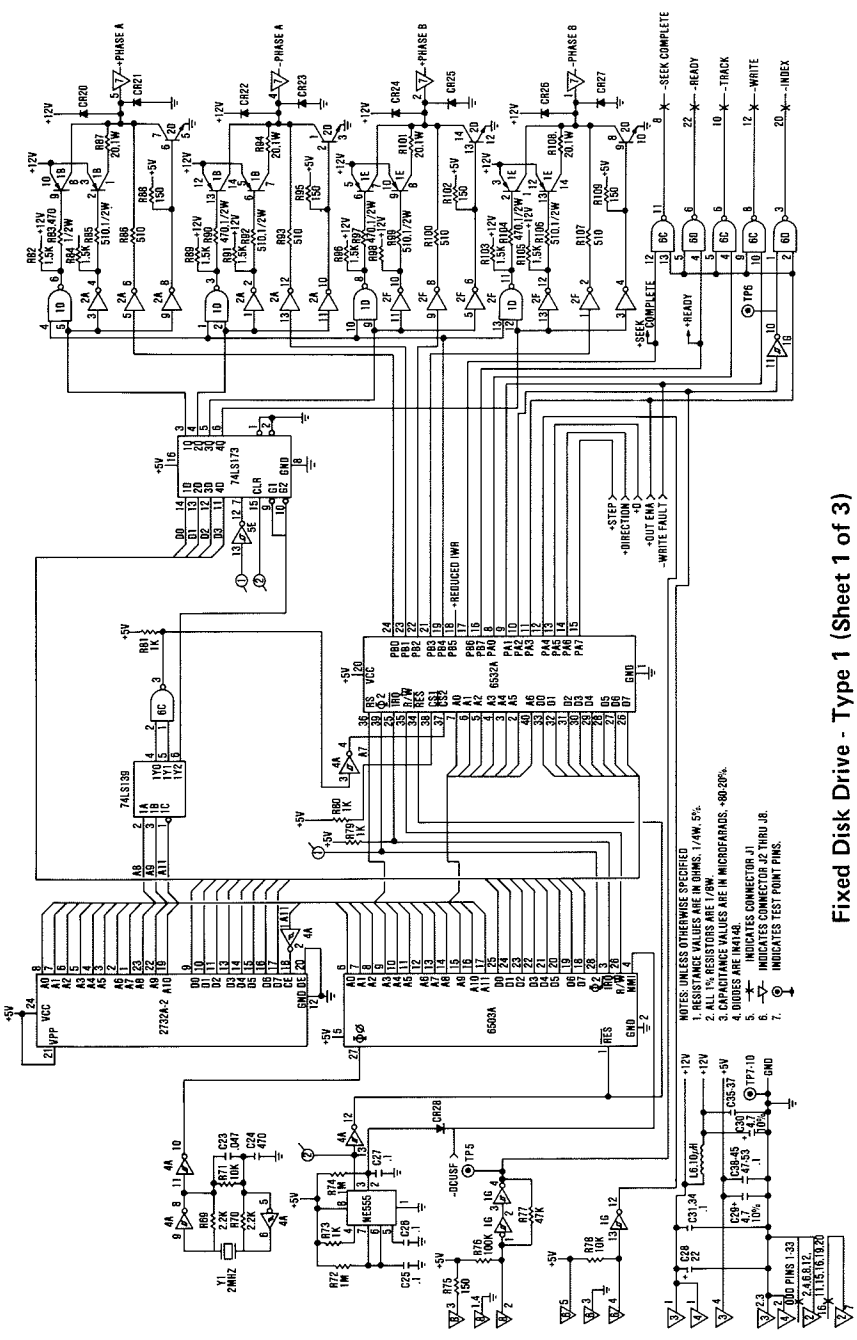

- NOTES: UNLESS OTHERWISE SPECIFIED
1. RESISTANCE VALUES ARE IN OHMS. 1/4W. 5%.
 2. ALL 1% RESISTORS ARE 1/8W.
 3. CAPACITANCE VALUES ARE IN MICROFARADS. +80.20%.
 4. DIODES ARE 1N4148.
 5. ∇ INDICATES CONNECTOR J1.
 6. ∇ INDICATES CONNECTOR J2 THRU J8.
 7. ∇ INDICATES TEST POINT PINS.

Fixed Disk Drive - Type 1 (Sheet 1 of 3)

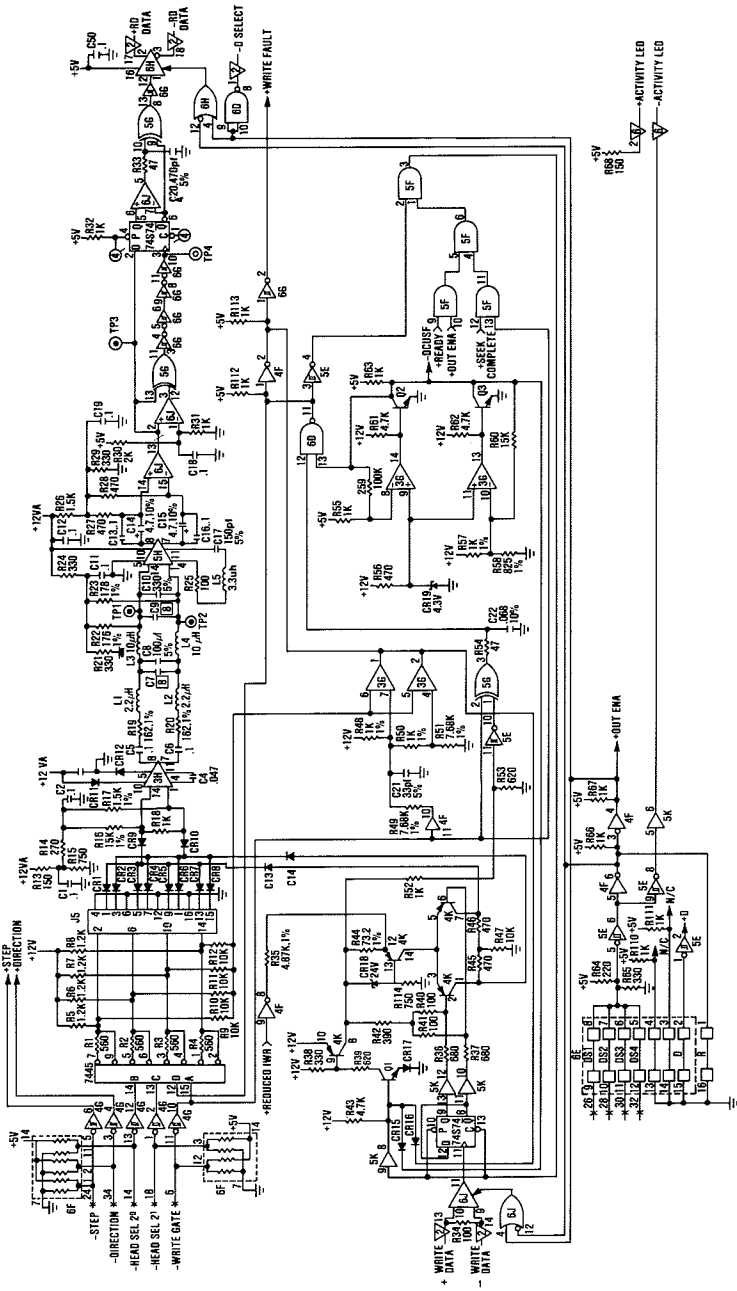

Fixed Disk Drive - Type 1 (Sheet 2 of 3)

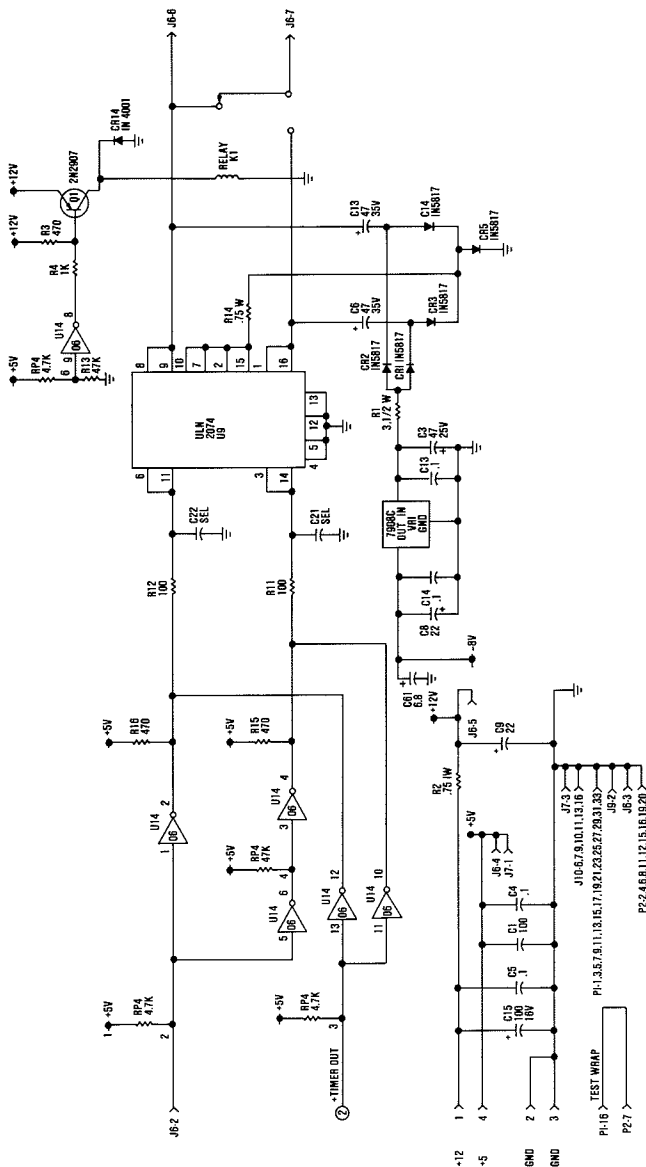

- NOTES:
1. SHEET TO SHEET CONNECTION IS AS FOLLOWS:
 2. UNLESS OTHERWISE SPECIFIED ALL RESISTORS ARE 1/4W 5% VALUE IN OHMS
 3. CAPACITORS -80-20% VALUE IN μ F
 3. ET IS A PROGRAMMABLE JUMPER SOCKET

Fixed Disk Drive - Type 2 (Sheet 1 of 3)

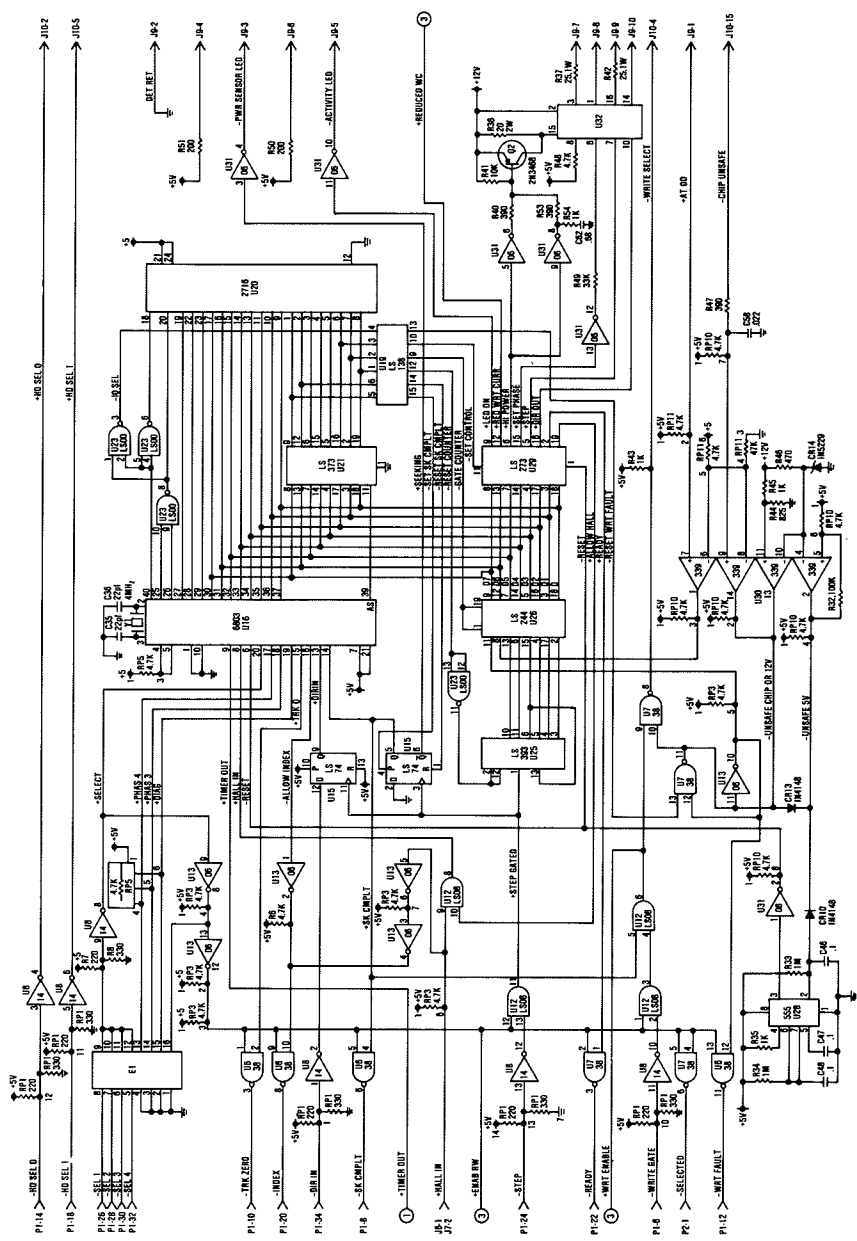

Fixed Disk Drive - Type 2 (Sheet 2 of 3)

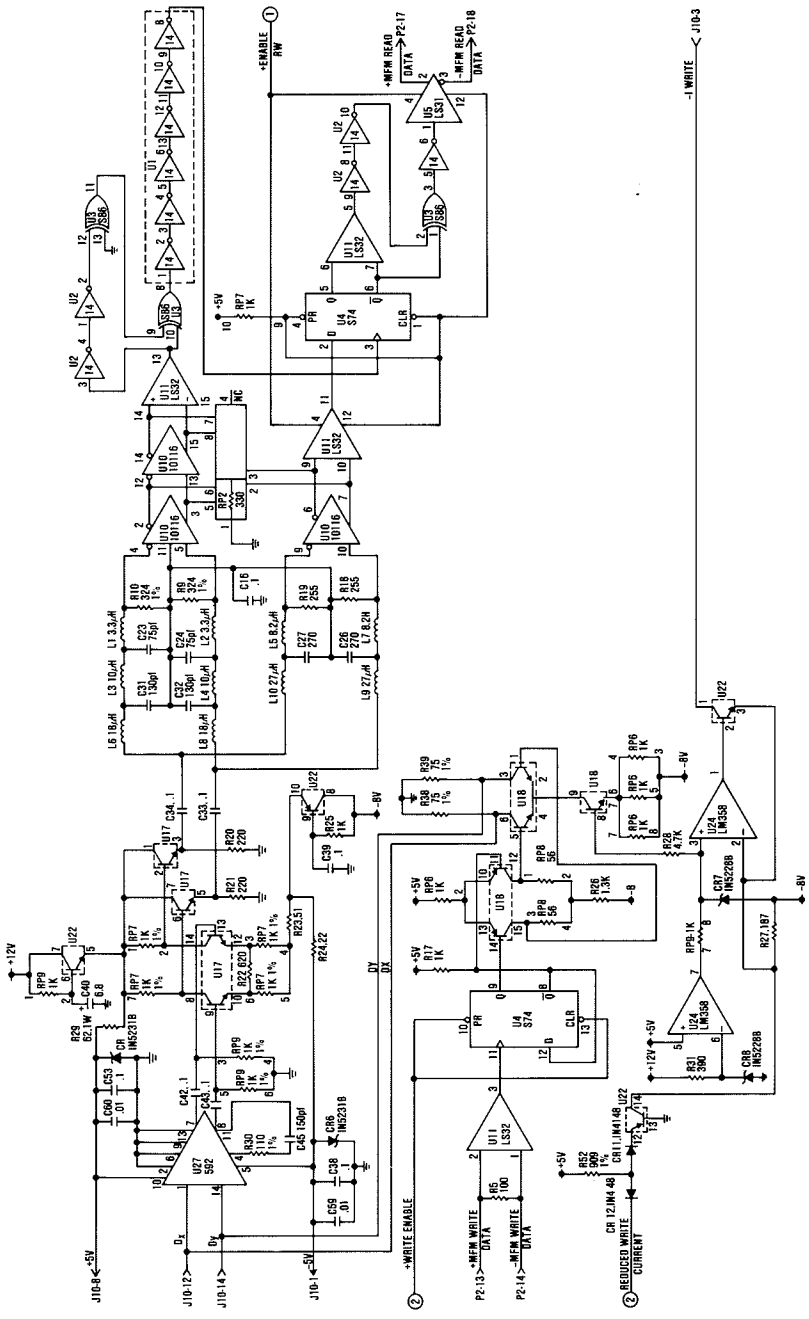

Fixed Disk Drive - Type 2 (Sheet 3 of 3)

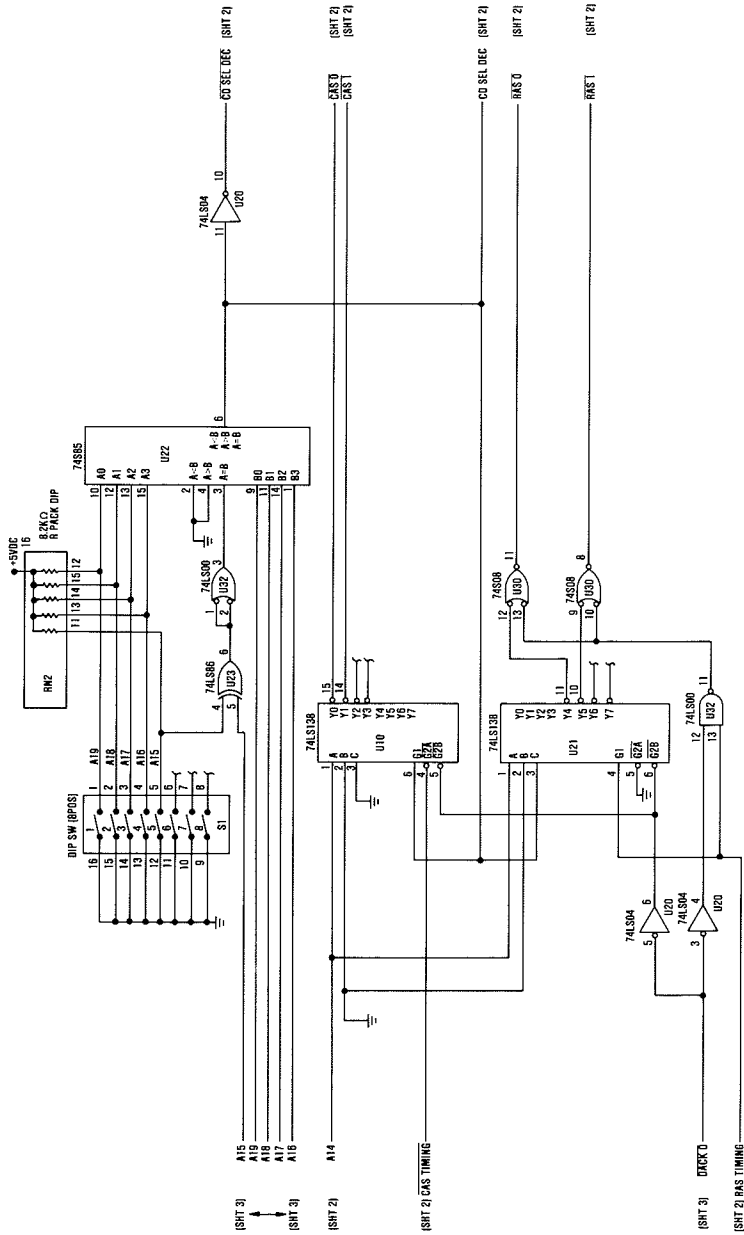

32K Memory Expansion Option (Sheet 1 of 3)

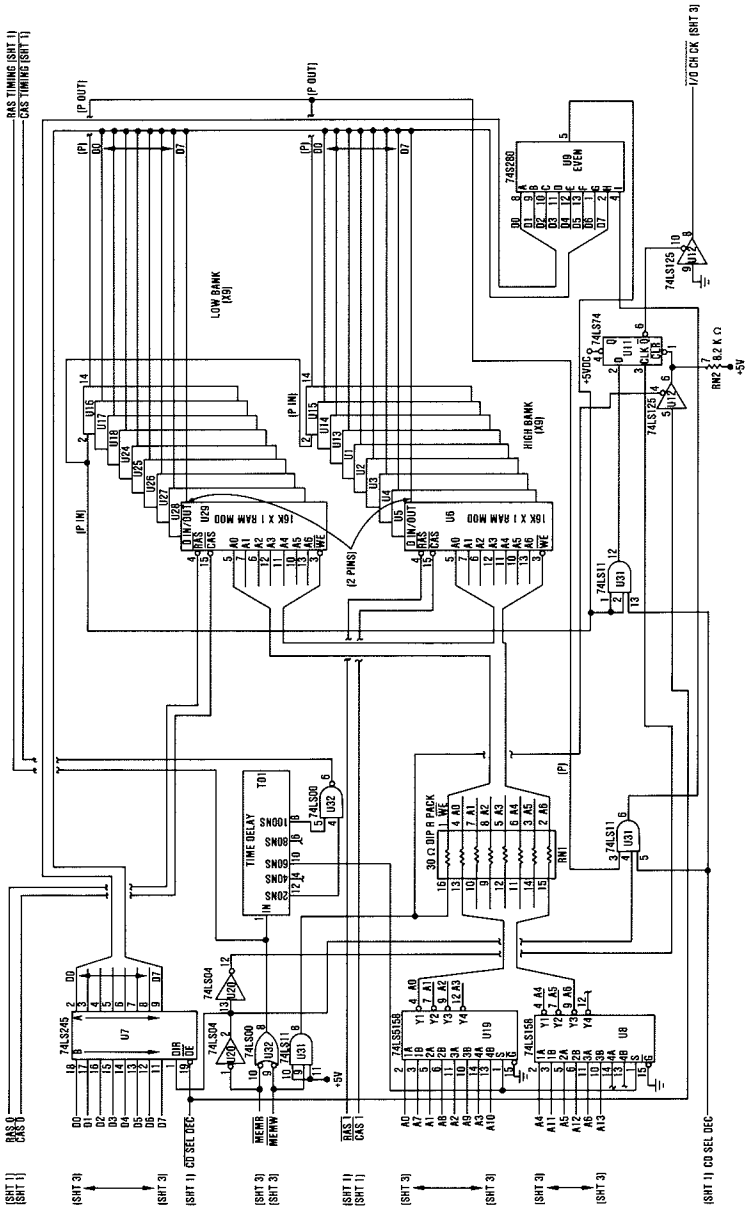

32K Memory Expansion Option (Sheet 2 of 3)

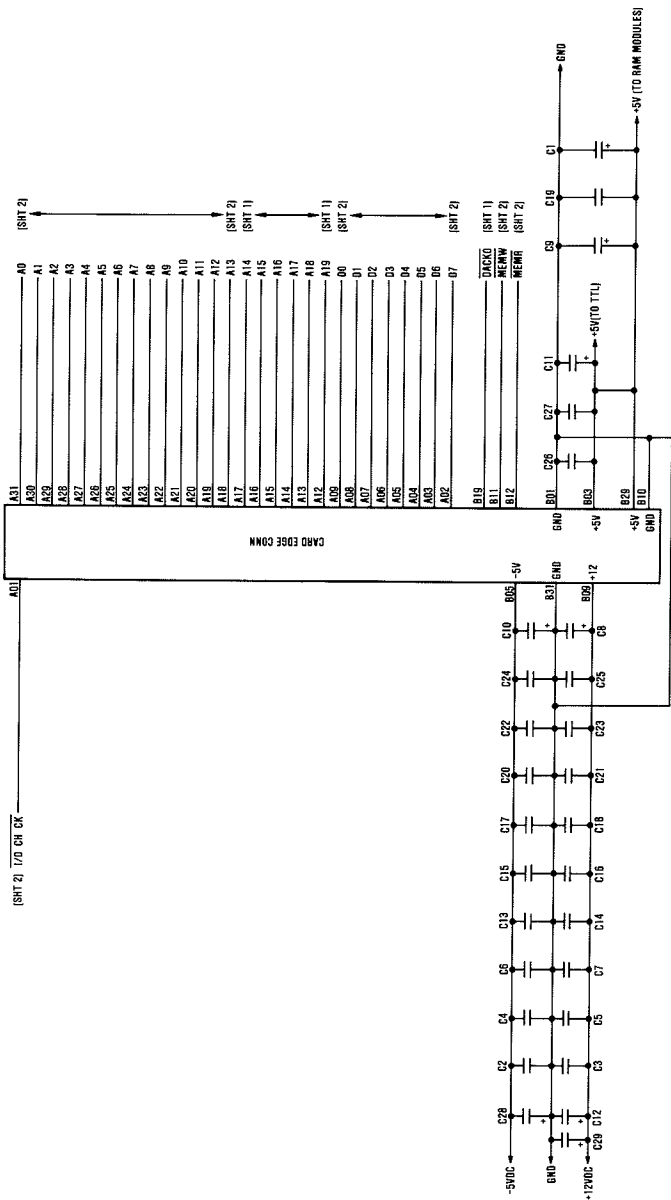

32K Memory Expansion Option (Sheet 3 of 3)

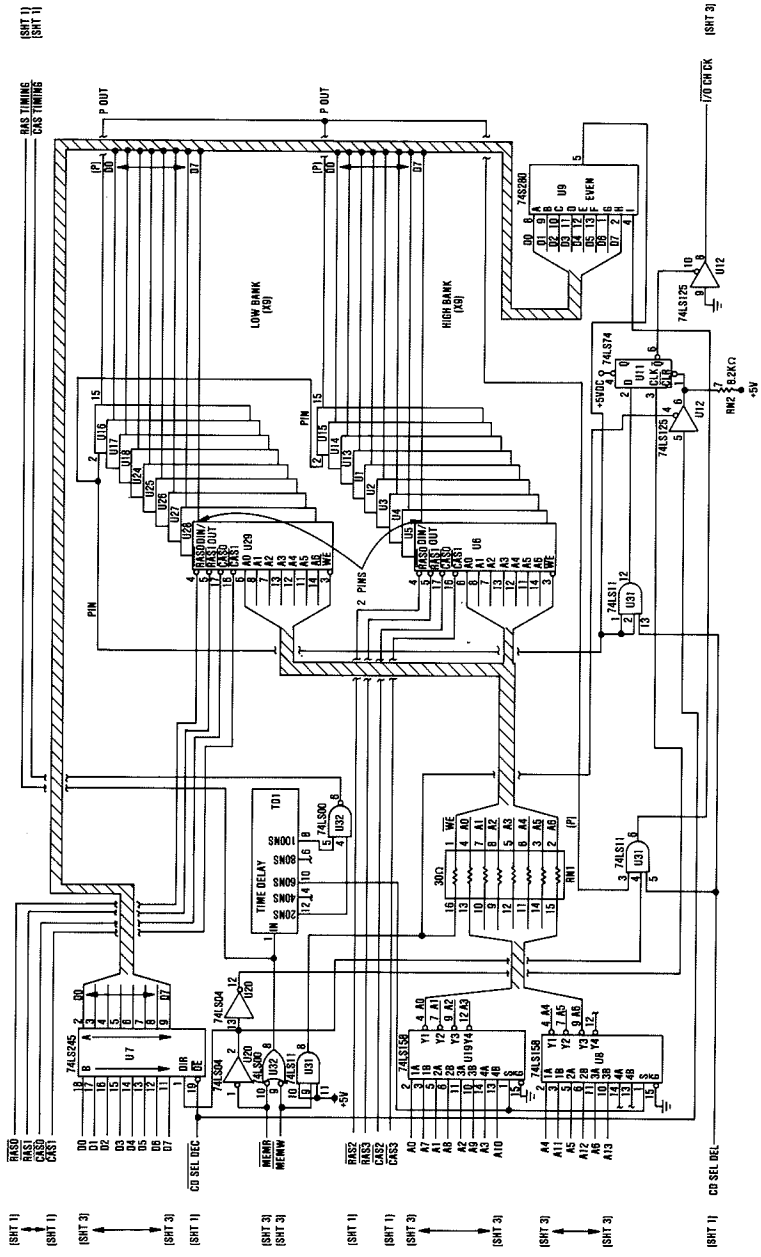

64K Memory Expansion Option (Sheet 2 of 3)

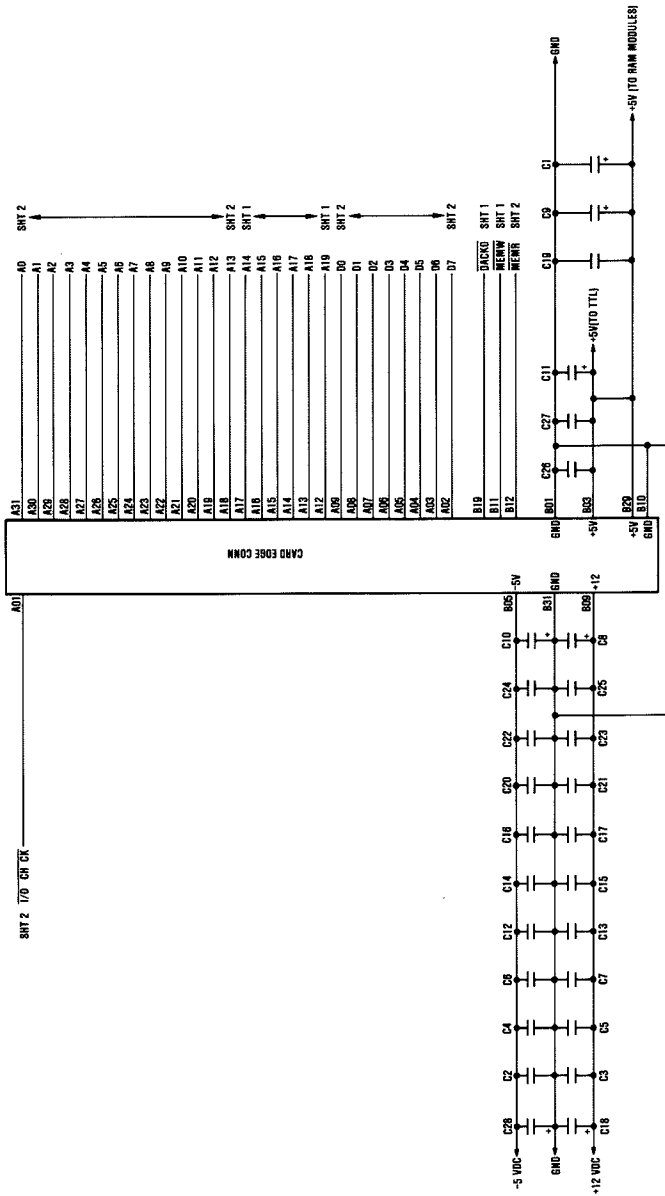

64K Memory Expansion Option (Sheet 3 of 3)

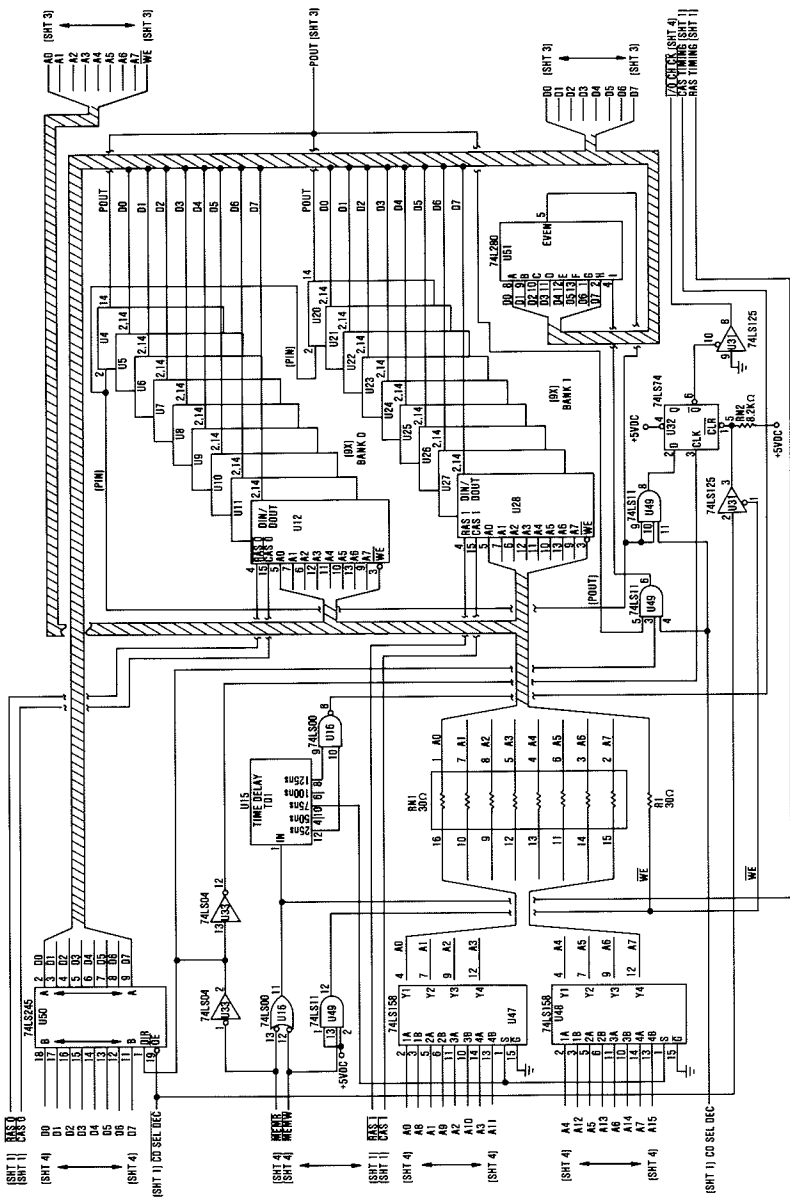

64/256K Memory Expansion Option (Sheet 2 of 4)

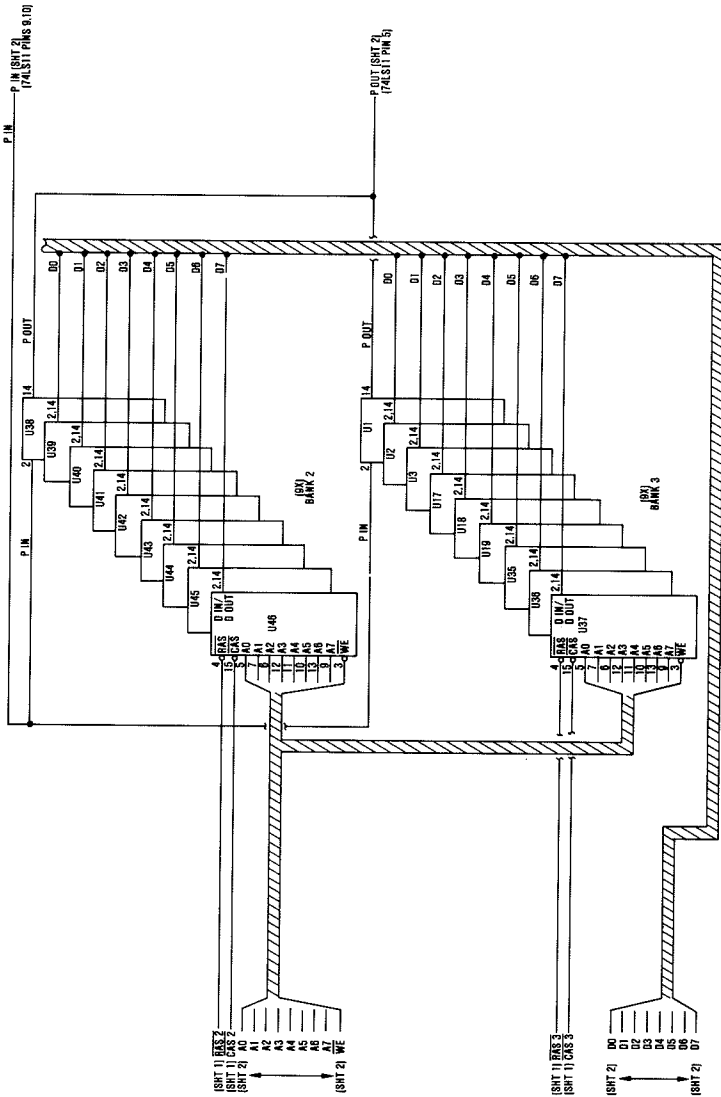

64/256K Memory Expansion Option (Sheet 3 of 4)

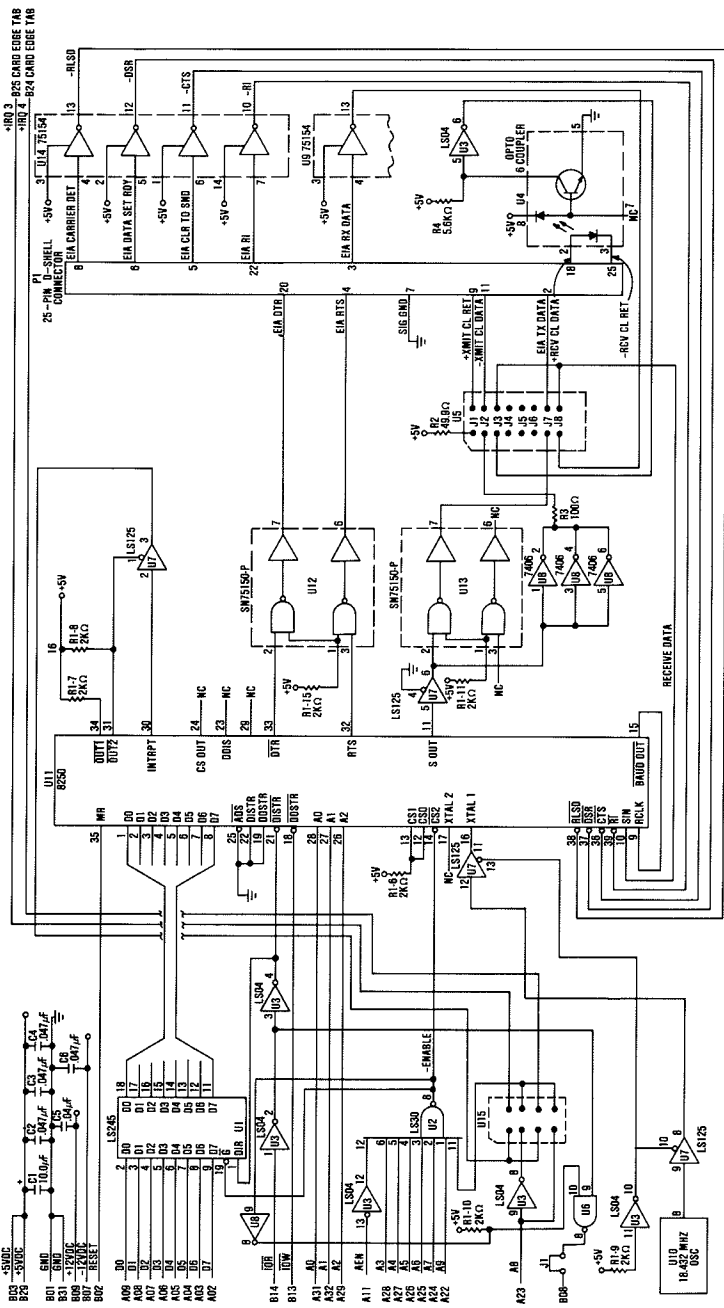

Asynchronous Communications Adapter (Sheet 1 of 1)

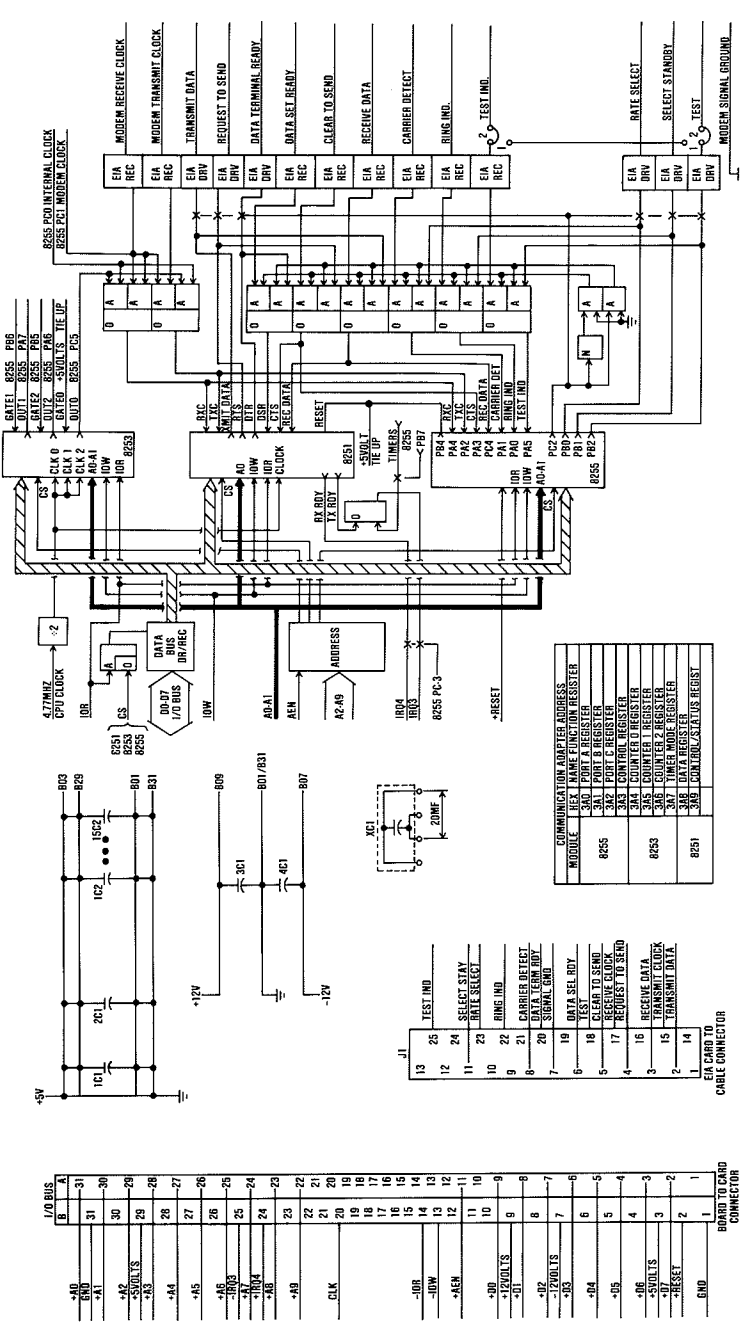

Binary Synchronous Communications Adapter (Sheet 1 of 2)

BOARD TO BOARD CONNECTOR	CONNECTION
1	DATA TO BOARD
2	DATA REGISTER
3	DATA REGISTER
4	DATA REGISTER
5	DATA REGISTER
6	DATA REGISTER
7	DATA REGISTER
8	DATA REGISTER
9	DATA REGISTER
10	DATA REGISTER
11	DATA REGISTER
12	DATA REGISTER
13	DATA REGISTER
14	DATA REGISTER
15	DATA REGISTER
16	DATA REGISTER
17	DATA REGISTER
18	DATA REGISTER
19	DATA REGISTER
20	DATA REGISTER
21	DATA REGISTER
22	DATA REGISTER
23	DATA REGISTER
24	DATA REGISTER
25	DATA REGISTER
26	DATA REGISTER
27	DATA REGISTER
28	DATA REGISTER
29	DATA REGISTER
30	DATA REGISTER
31	DATA REGISTER
32	DATA REGISTER
33	DATA REGISTER
34	DATA REGISTER
35	DATA REGISTER
36	DATA REGISTER
37	DATA REGISTER
38	DATA REGISTER
39	DATA REGISTER
40	DATA REGISTER
41	DATA REGISTER
42	DATA REGISTER
43	DATA REGISTER
44	DATA REGISTER
45	DATA REGISTER
46	DATA REGISTER
47	DATA REGISTER
48	DATA REGISTER
49	DATA REGISTER
50	DATA REGISTER
51	DATA REGISTER
52	DATA REGISTER
53	DATA REGISTER
54	DATA REGISTER
55	DATA REGISTER
56	DATA REGISTER
57	DATA REGISTER
58	DATA REGISTER
59	DATA REGISTER
60	DATA REGISTER
61	DATA REGISTER
62	DATA REGISTER
63	DATA REGISTER
64	DATA REGISTER
65	DATA REGISTER
66	DATA REGISTER
67	DATA REGISTER
68	DATA REGISTER
69	DATA REGISTER
70	DATA REGISTER
71	DATA REGISTER
72	DATA REGISTER
73	DATA REGISTER
74	DATA REGISTER
75	DATA REGISTER
76	DATA REGISTER
77	DATA REGISTER
78	DATA REGISTER
79	DATA REGISTER
80	DATA REGISTER
81	DATA REGISTER
82	DATA REGISTER
83	DATA REGISTER
84	DATA REGISTER
85	DATA REGISTER
86	DATA REGISTER
87	DATA REGISTER
88	DATA REGISTER
89	DATA REGISTER
90	DATA REGISTER
91	DATA REGISTER
92	DATA REGISTER
93	DATA REGISTER
94	DATA REGISTER
95	DATA REGISTER
96	DATA REGISTER
97	DATA REGISTER
98	DATA REGISTER
99	DATA REGISTER
100	DATA REGISTER

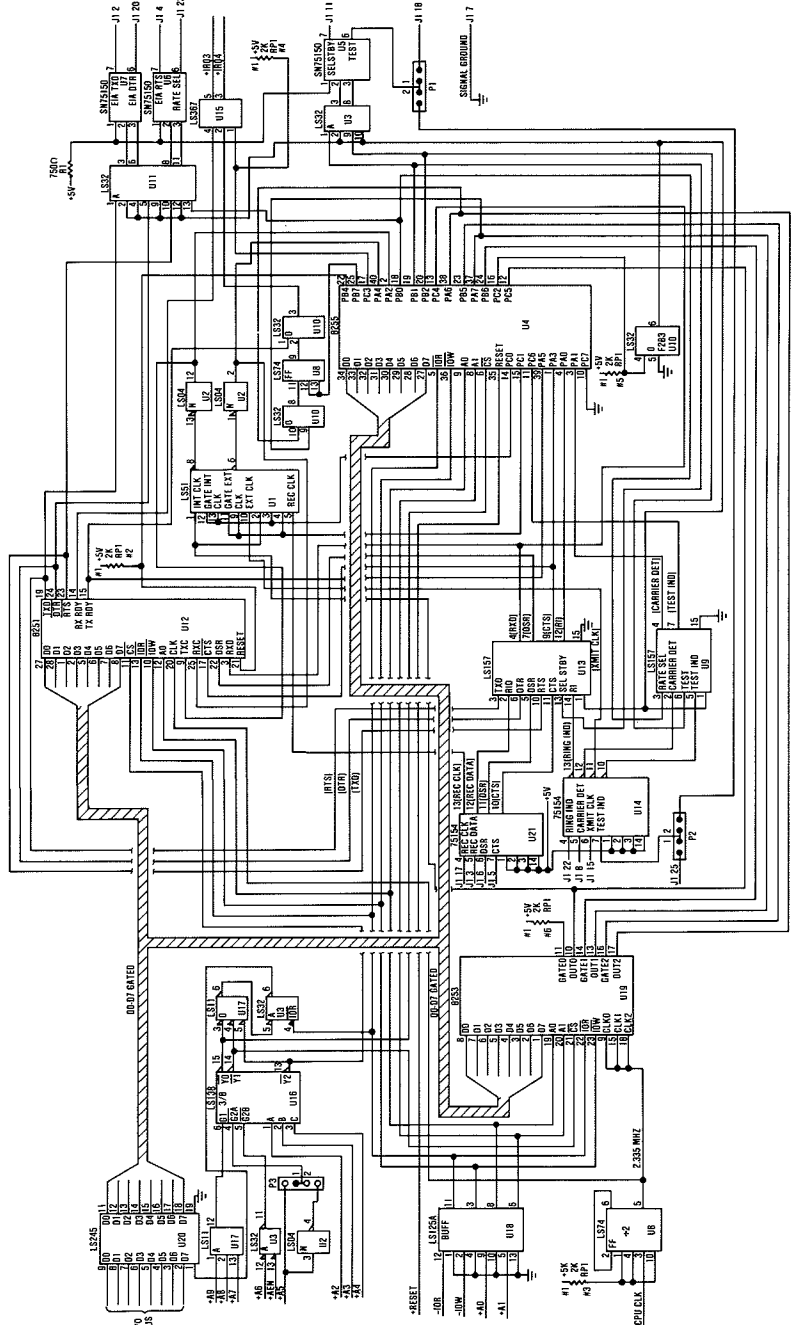

Binary Synchronous Communications Adapter (Sheet 2 of 2)

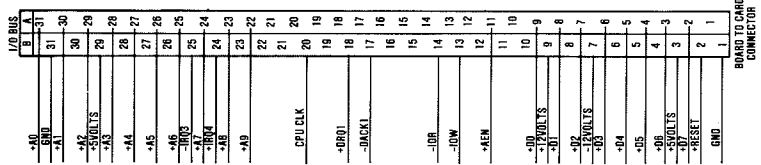
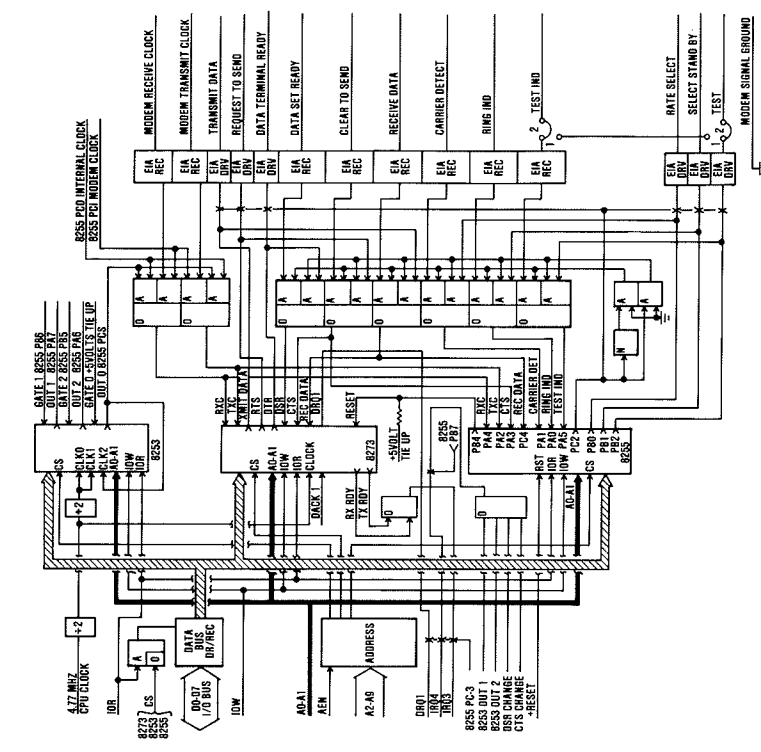
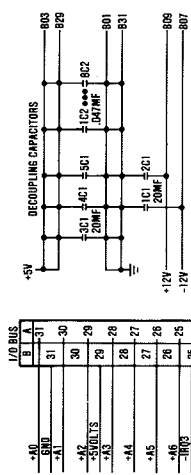

SDLC Communications Adapter (Sheet 1 of 2)

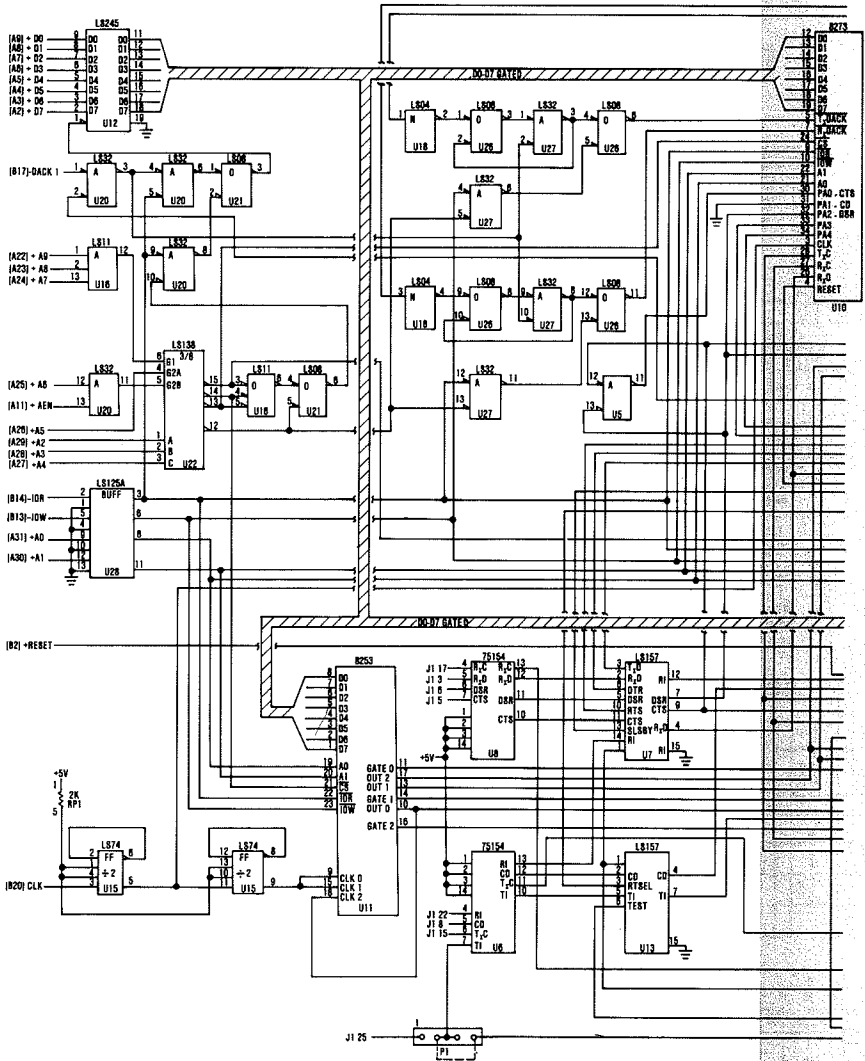

SDLC Communications Adapter (Sheet 1 of 2)

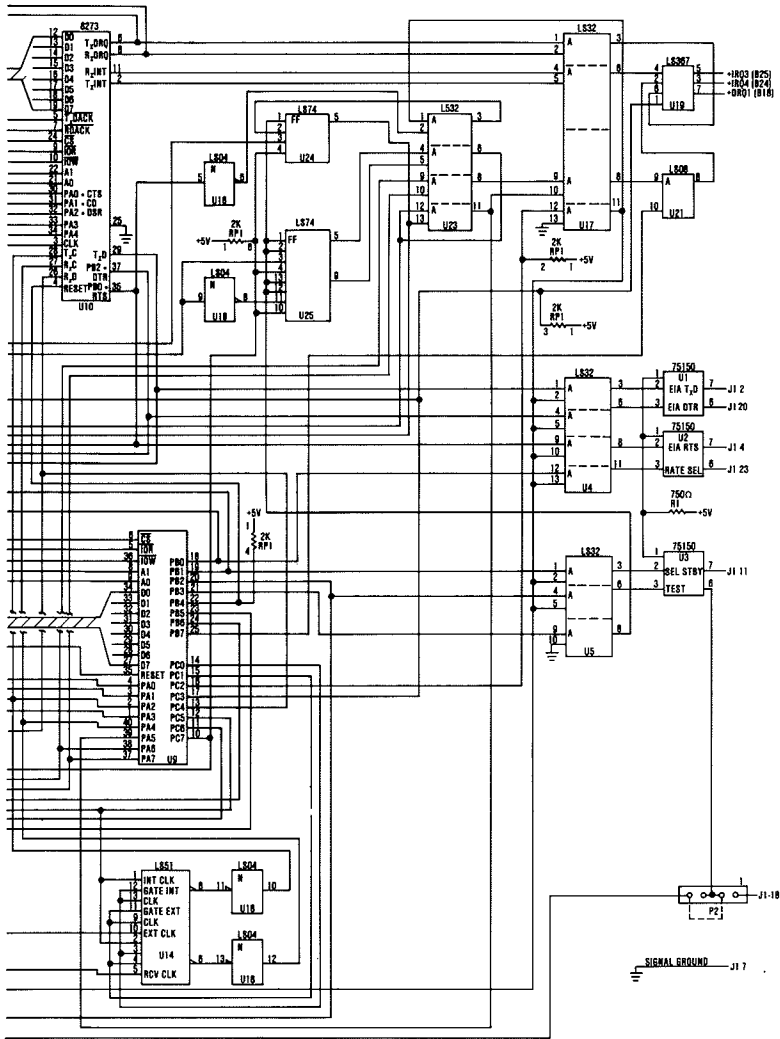

SDLC Communications Adapter (Sheet 2 of 2)

Notes:

APPENDIX E: SPECIFICATIONS

System Unit

Size:

Length--19.6 in (500 mm)

Depth--16.1 in (410 mm)

Height--5.5 in (142 mm)

Weight:

20.9 lb (9.5 kg) Without a diskette drive unit

25.0 lb (11.4 kg) With one diskette drive unit

Power Cable:

Length--6 ft (1.83 m)

Size--18 AWG

Environment:

Air Temperature

System ON, 60° to 90° F (15.6° to 32.2° C)

System OFF, 50° to 110° F (10° to 43° C)

Humidity

System ON, 8% to 80%

System OFF, 20% to 80%

Heat Output:

1083 BTU/hr

Noise Level:

56 dB Without printer

66 dB With printer

Electrical:

Nominal--120 Vac

Minimum--104 Vac

Maximum--127 Vac

kVA--0.3175 (maximum)

Keyboard

Size:

Length--19.6 in (500 mm)

Depth--7.87 in (200 mm)

Height--2.2 in (57 mm)

Weight:

6.5 lb (2.9 kg)

Color Display

Size:

Length--15.4 in (392 mm)

Depth--15.6 in (407 mm)

Height--11.7 in (297 mm)

Weight:

26 lb (11.8 kg)

Heat Output:

240 BTU/hr

Power Cable:

Length--6 ft (1.83 m)

Size--18 AWG

Signal Cable:

Length--5 ft (1.5 m)

Size--22 AWG

Expansion Unit

Size:

Length--19.6 in (500 mm)

Depth--16.1 in (410 mm)

Height--5.5 in (142 mm)

Weight:

33 lb (14.9 kg)

Power Cable:

Length--6 ft (1.83 m)

Size--18 AWG

Signal Cable:

Length--3.28 ft (1 m)

Size--22 AWG

Environment:

Air Temperature

System ON, 60° to 90° F (15.6° to 32.2° C)

System OFF, 50° to 110° F (10° to 43° C)

Humidity

System ON, 8% to 80%

System OFF, 20% to 80%

Heat Output:

717 BTU/hr

Electrical:

Nominal--120 Vac

Minimum--104 Vac

Maximum--127 Vac

Monochrome Display

Size:

Length--14.9 in (380 mm)

Depth--13.7 in (350 mm)

Height--11 in (280 mm)

Weight:

17.3 lb (7.9 kg)

Heat Output:

325 BTU/hr

Power Cable:

Length--3 ft (0.914 m)

Size--18 AWG

Signal Cable:

Length--4 ft (1.22 m)

Size--22 AWG

80 CPS Printers

Size:

Length--15.7 in (400 mm)

Depth--14.5 in (370 mm)

Height--4.3 in (110 mm)

Weight:

12.9 lb (5.9 kg)

Power Cable:

Length--6 ft (1.83 mm)

Size--22 AWG

Heat Output:

341 BTU/hr (maximum)

Electrical:

Nominal--120 Vac

Minimum--104 Vac

Maximum--127 Vac

Card Specifications

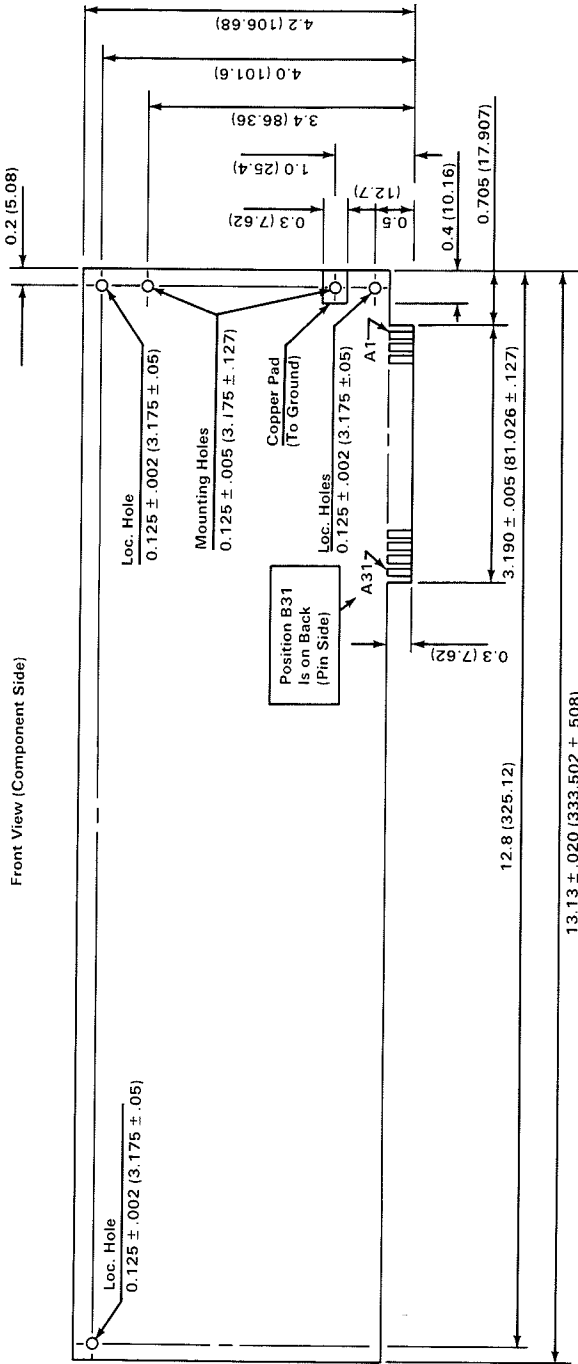

- Notes:
- All Card Dimensions are ± .010 (.254) Tolerance (With Exceptions Indicated on Drawing or in Notes).
 - Max. Card Length is 13.15 (334.01) Smaller Length is Permissible.
 - Loc. and Mounting Holes are Non-Plated Thru. (Loc. 3X, Mtg. 2X).
 - 31 Gold Tabs Each Side, 0.100 ± .0005 (2.54 ± .0127) Center to Center, 0.06 ± .0005 (1.524 ± .0127) Width.
 - Numbers in Parentheses are in Millimeters. All Others are in Inches.

APPENDIX F: COMMUNICATIONS

Information processing equipment used for communications is called data terminal equipment (DTE). Equipment used to connect the DTE to the communications line is called data communications equipment (DCE).

An adapter is used to connect the data terminal equipment to the data communications line as shown in the following illustration:

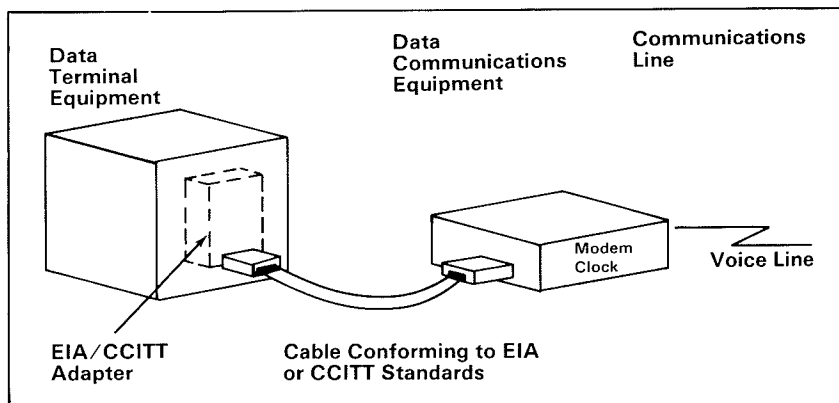

The EIA/CCITT adapter allows data terminal equipment to be connected to data communications equipment using EIA or CCITT standardized connections. An external modem is shown in this example; however, other types of data communications equipment can also be connected to data terminal equipment using EIA or CCITT standardized connections.

EIA standards are labeled RS-x (Recommended Standards-x) and CCITT standards are labeled V.x or X.x, where x is the number of the standard.

The EIA RS-232 interface standard defines the connector type, pin numbers, line names, and signal levels used to connect data terminal equipment to data communications equipment for the purpose of transmitting and receiving data. Since the RS-232 standard was developed, it has been revised three times. The three revised standards are the RS-232A, the RS-232B, and the presently used RS-232C.

The CCITT V.24 interface standard is equivalent to the RS-232C standard; therefore, the descriptions of the EIA standards also apply to the CCITT standards.

The following is an illustration of data terminal equipment connected to an external modem using connections defined by the RS-232C interface standard:

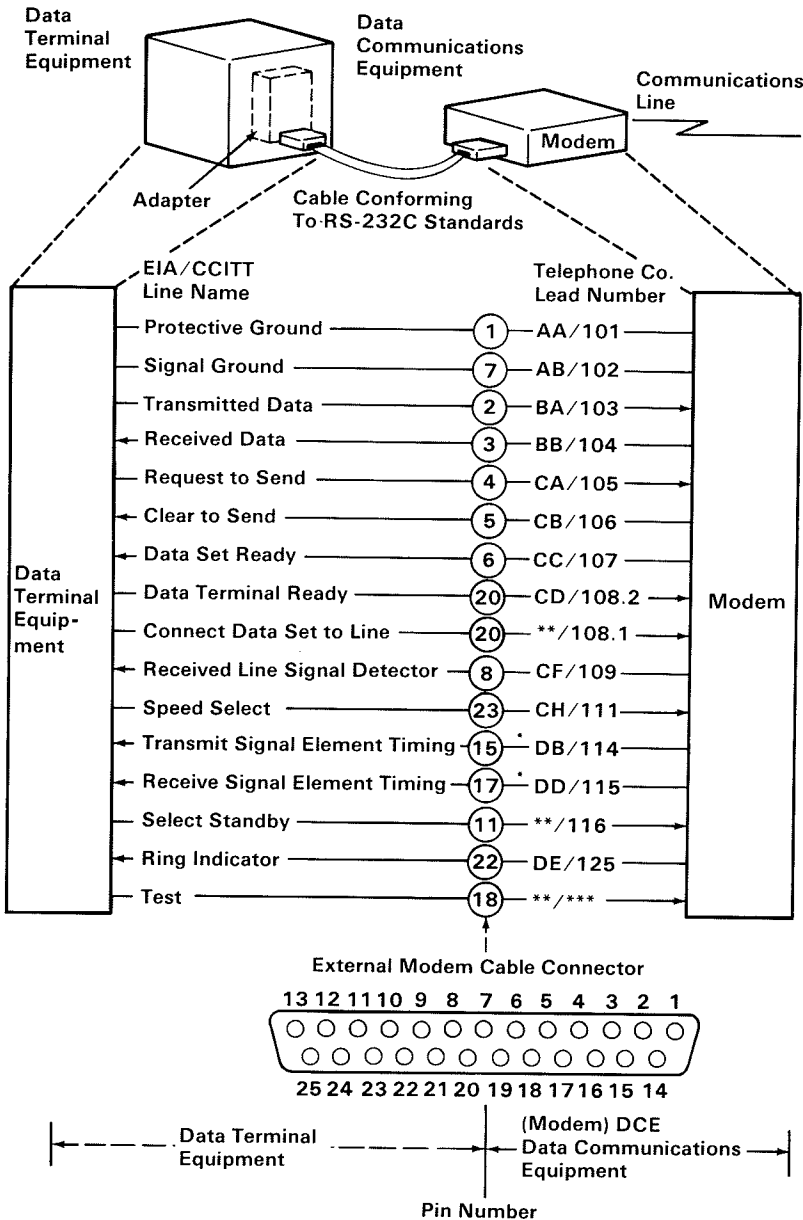

*Not used when business machine clocking is used.
 **Not standardized by EIA (Electronics Industry Association).
 ***Not standardized by CCITT

Establishing a Communications Link

The following bar graphs represent normal timing sequences of operation during the establishment of communications for both switched (dial-up) and nonswitched (direct line) networks.

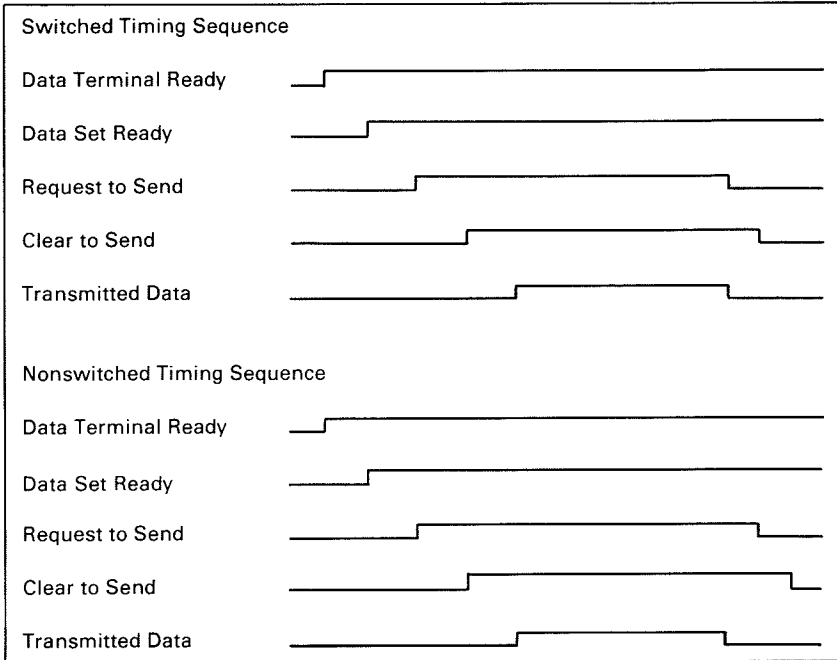

The following examples show how a link is established on a nonswitched point-to-point line, a nonswitched multipoint line, and a switched point-to-point line.

Establishing a Link on a Nonswitched Point-to-Point Line

- The terminals at both locations activate the 'data terminal ready' lines **1** and **3**.
- Normally the 'data set ready' lines **2** and **9** from the modems are active whenever the modems are powered on.
- Terminal A activates the 'request to send' line **3**, which causes the modem at terminal A to generate a carrier signal.
- Modem B detects the carrier, and activates the 'received line signal detector' line (sometimes called data carrier detect) **10**. Modem B also activates the 'receiver signal element timing' line (sometimes called receive clock) **11** to send receive clock signals to the terminal. Some modems activate the clock signals whenever the modem is powered on.
- After a specified delay, modem A activates the 'clear to send' line **4**, which indicates to terminal A that the modem is ready to transmit data.
- Terminal A serializes the data to be transmitted (through the serdes) and transmits the data one bit at a time (synchronized by the transmit clock) onto the 'transmitted data' line **6** to the modem.
- The modem modulates the carrier signal with the data and transmits it to the modem B **5**.
- Modem B demodulates the data from the carrier signal and sends it to terminal B on the 'received data' line **12**.
- Terminal B deserializes the data (through the serdes) using the receive clock signals (on the 'receiver signal element timing' line) **11** from the modem.
- After terminal A completes its transmission, it deactivates the 'request to send' line **3**, which causes the modem to turn off the carrier and deactivate the 'clear to send' line **4**.
- Terminal A and modem A now become receivers and wait for a response from terminal B, indicating that all data has reached terminal B. Modem A begins an echo delay (50 to 150 milliseconds) to ensure that all echoes on the line have diminished before it begins receiving. An echo is a reflection of the transmitted signal. If the transmitting modem changed to receive too soon, it could receive a reflection (echo) of the signal it just transmitted.
- Modem B deactivates the 'received line signal detector' line **10** and, if necessary, deactivates the receive clock signals on the 'receiver signal element timing, line **11**.
- Terminal B now becomes the transmitter to respond to the request from terminal A. To transmit data, terminal B activates the 'request to send' line **13**, which causes modem B to transmit a carrier to modem A.
- Modem B begins a delay that is longer than the echo delay at modem A before turning on the 'clear to send' line. The longer delay (called request-to-send to clear-to-send delay) ensures that modem A is ready to receive when terminal B begins transmitting data. After the delay, modem B activates the 'clear to send' line **14** to indicate that terminal B can begin transmitting its response.
- After the echo delay at modem A, modem A senses the carrier from modem B (the carrier was activated in step 13 when terminal B activated the 'request to send' line) and activates the 'received line signal detector' line **7** to terminal A.
- Modem A and terminal A are now ready to receive the response from terminal B. Remember, the response was not transmitted until after the request-to-send to clear-to-send delay at modem B (step 14).

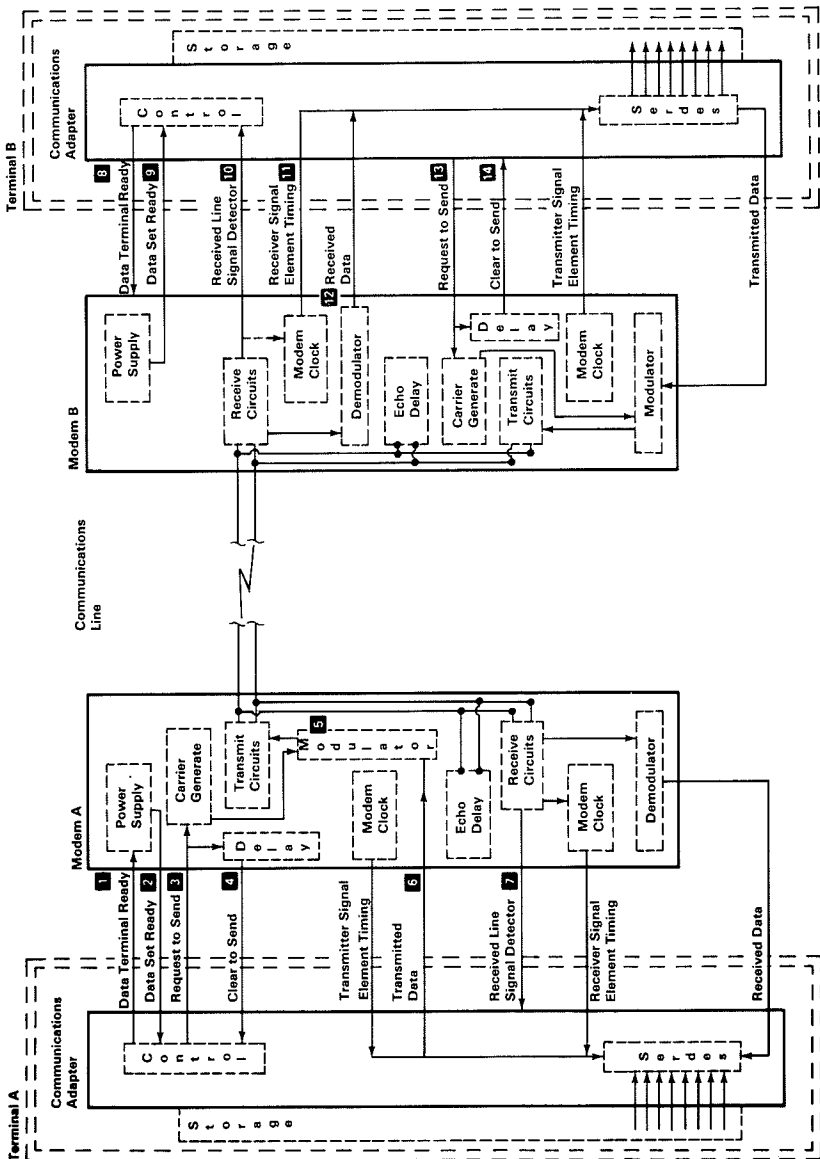

Appendix F

Establishing a Link on a Nonswitched Multipoint Line

1. The control station serializes the address for the tributary or secondary station (AA) and sends its address to the modem on the 'transmitted data' line **2**.
2. Since the 'request to send' line and, therefore, the modem carrier, is active continuously **1**, the modem immediately modulates the carrier with the address, and, thus, the address is transmitted to all modems on the line.
3. All tributary modems, including the modem for station A, demodulate the address and send it to their terminals on the 'received data' line **5**.
4. Only station A responds to the address; the other stations ignore the address and continue monitoring their 'received data' line. To respond to the poll, station A activates its 'request to send' line **6**, which causes the modem to begin transmitting a carrier signal.
5. The control station's modem receives the carrier and activates the 'received line signal detector, line **3** and the 'receiver signal element timing' line **4** (to send clock signals to the control station). Some modems activate the clock signals as soon as they are powered on.
6. After a short delay to allow the control station modem to receive the carrier, the tributary modem activates the 'clear to send' line **7**.
7. When station A detects the active 'clear to send' line, it transmits its response. (For this example, assume that station A has no data to send; therefore, it transmits an EOT **8**.)
8. After transmitting the EOT, station A deactivates the 'request to send' line **6**. This causes the modem to deactivate the carrier and the 'clear to send' line **7**.
9. When the modem at the control station (host) detects the absence of the carrier, it deactivates the 'received line signal detector' line **3**.
10. Tributary station A is now in receive mode waiting for the next poll or select transmission from the control station.

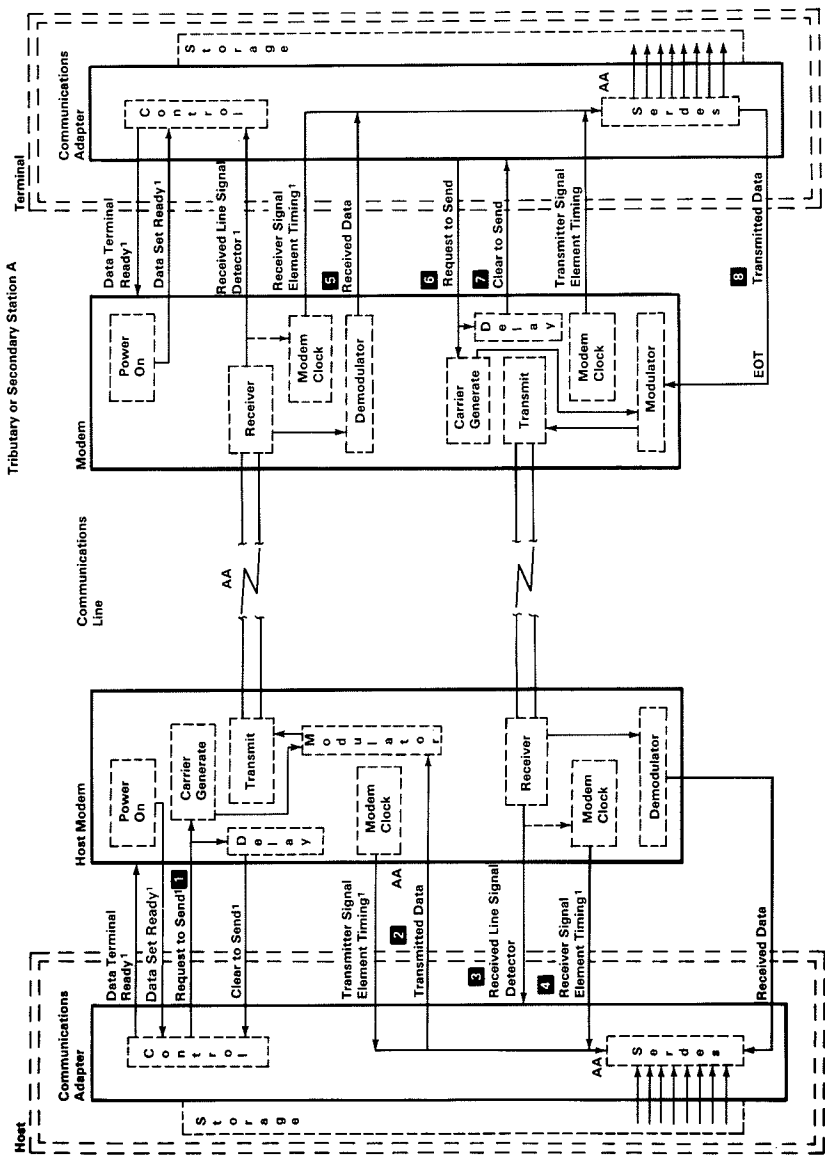

¹These lines are active continuously.

Establishing a Link on a Switched Point-To-Point Line

1. Terminal A is in communications mode; therefore, the 'data terminal ready' line **1** is active. Terminal B is in communication mode waiting for a call from terminal A.
 2. When the terminal A operator lifts the telephone handset, the 'switch hook' line from the coupler is activated **3**.
 3. Modem A detects the 'switch hook' line and activates the 'off hook' line **4**, which causes the coupler to connect the telephone set to the line and activate the 'coupler cut-through' line **5** to the modem.
 4. Modem A activates the 'data modem ready' line **6** to the coupler (the 'data modem ready' line is on continuously in some modems).
 5. The terminal A operator sets the exclusion key or talk/data switch to the talk position to connect the communications line. The operator then dials the terminal B number.
 6. When the telephone at terminal B rings, the coupler activates the 'ring indicate' line to modem B **10**. Modem B indicates that the 'ring indicate' line was activated by activating the 'ring indicator' line **13** to terminal B.
 7. Terminal B activates the 'data terminal ready' line to modem B **12**, which activates the autoanswer circuits in modem B. (The 'data terminal ready' line might already be active in some terminals.)
 8. The autoanswer circuits in modem B activate the 'off hook' line to the coupler **8**.
 9. The coupler connects modem B to the communications line through the 'data tip' and 'data ring' lines **11** and activates the 'coupler cut-through' line **9** to the modem. Modem B then transmits an answer tone to terminal A.
 10. The terminal A operator hears the tone and sets the exclusion key or talk/data switch to the data position (or performs an equivalent operation) to connect modem A to the communications line through the 'data tip' and 'data ring' lines **7**.
 11. The coupler at terminal A deactivates the 'switch hook' line **3**. This causes modem A to activate the 'data set ready' line **2** indicating to terminal A that the modem is connected to the communications line.
- The sequence of the remaining steps to establish the data link is the same as the sequence required on a nonswitched point-to-point line. When the terminals have completed their transmission, they both deactivate the 'data terminal ready' line to disconnect the modems from the line.

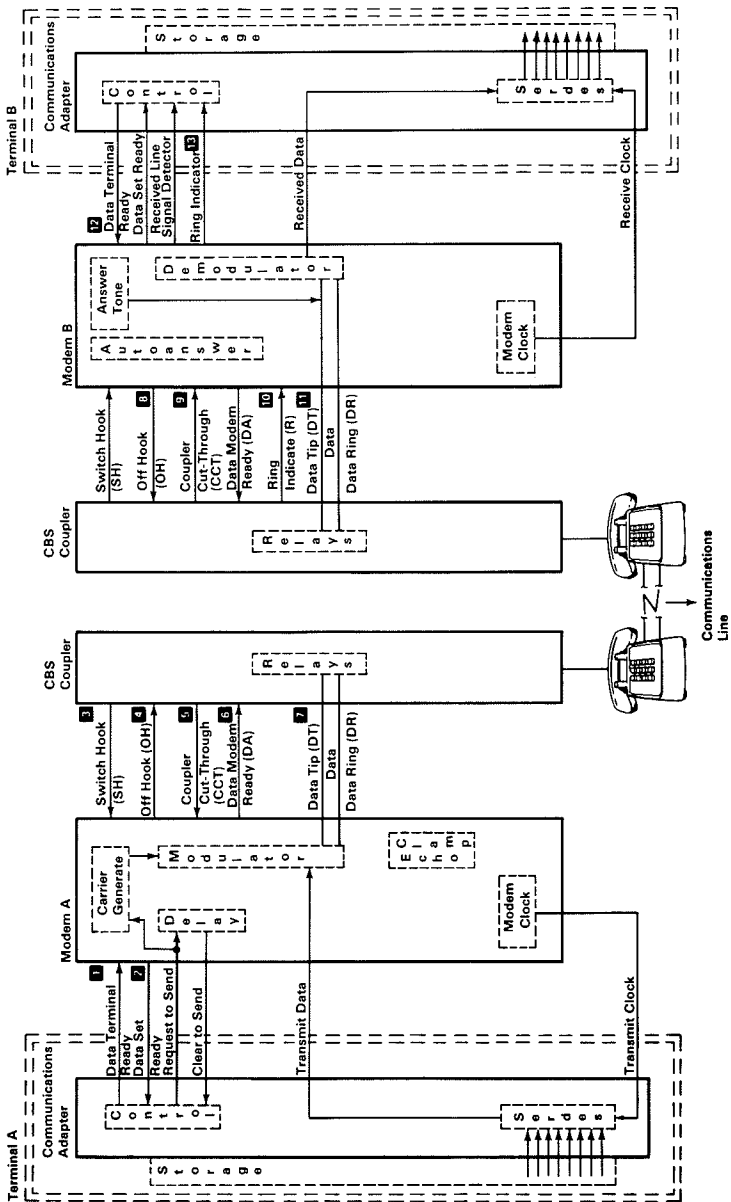

Notes:

APPENDIX G: SWITCH SETTINGS

The following switch settings are divided between two groups. The first group contains the switch settings for the 16/64K system board. The second group contains the 64/256K system board switch settings.

Determine the system board type and refer to the appropriate group of switch settings for all applications.

Switch Settings (16KB-64KB CPU)	G-3
Switch Settings (64KB-256KB CPU)	G-29

Notes:

Switch Settings (16KB-64KB CPU)

System Board Switch Settings	G-5
System Board Switch Settings	G-5
5-1/4" Diskette Drives Switch Settings	G-6
Display Type Switch Settings	G-6
Math Coprocessor Switch Settings	G-7
Memory Option Switch Settings	G-8
16K Total Memory	G-8
32K Total Memory	G-8
48K Total Memory	G-8
64K Total Memory	G-8
96K Total Memory	G-9
128K Total Memory	G-10
160K Total Memory	G-11
192K Total Memory	G-12
224K Total Memory	G-13
256K Total Memory	G-14
288K Total Memory	G-15
320K Total Memory	G-16
352K Total Memory	G-17
384K Total Memory	G-18
416K Total Memory	G-19
448K Total Memory	G-20
480K Total Memory	G-21
512K Total Memory	G-22
544K Total Memory	G-23
576K Total Memory	G-24
608K Total Memory	G-25
640K Total Memory	G-26
Extender Card Switch Settings	G-27

Notes:

Switch Setting Charts

System Board Switches

WARNING: Before you change any switch settings, make a note of how the switches are presently set.

Switch Block 1

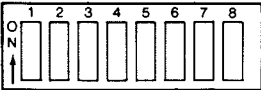

Switch	Function
1,7,8	Number of 5-1/4 inch diskette drives installed
2	Math Coprocessor
3,4	System board memory switches
5,6	Type(s) of display(s) connected

Switch Block 2

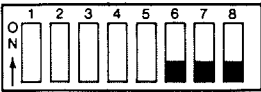

Switch	Function
1,2,3,4,5	Amount of memory options installed
6,7,8	Always in the Off position

Number of 5-1/4 Inch Diskette Drives Installed

Switch Block 1

Switch Block 2

0 – Drives

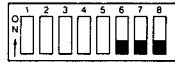
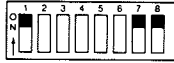

1 – Drive

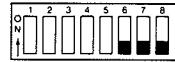
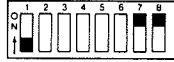

2 – Drives

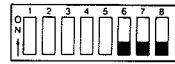
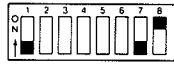

Type(s) of display(s) connected

WARNING:

If an IBM Monochrome Display is connected to your system. Switch Block 1, switches 5 and 6, must always be Off. Damage to your display can result with any other switch settings.

Switch Block 1

Switch Block 2

IBM Monochrome Display (or IBM Monochrome Display plus another display)

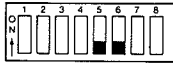

Switch Block 1

Switch Block 2

Color Display (Do not use if an IBM Monochrome Display is connected)

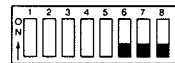

40x25
Mode

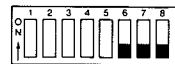

80x25
Mode

Note: The 40x25 mode means there will be 40 characters across the screen and 25 lines down the screen. The 80x25 mode means there will be 80 characters across the screen and 25 lines down the screen. The 80x25 mode, when used with home televisions and various displays, can cause loss of character quality.

Math Coprocessor

Switch Block 1

Switch Block 2

With Math Coprocessor

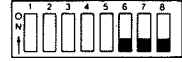
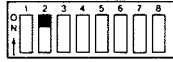

Without Math Coprocessor

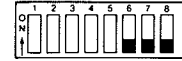
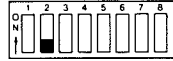

Memory Switch Settings (16KB-64KB CPU) System Board

16K Total Memory

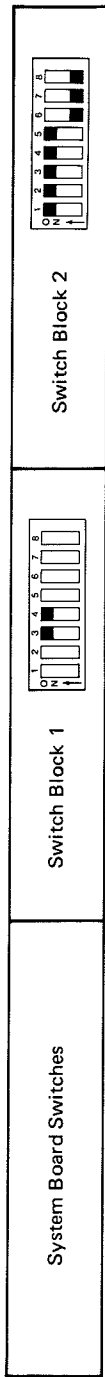

32K Total Memory

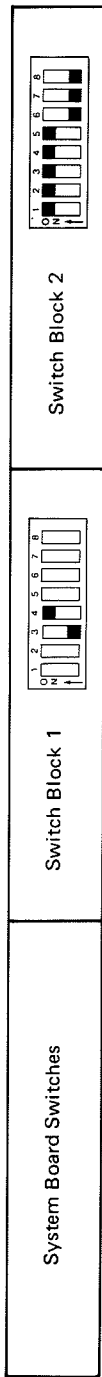

48K Total Memory

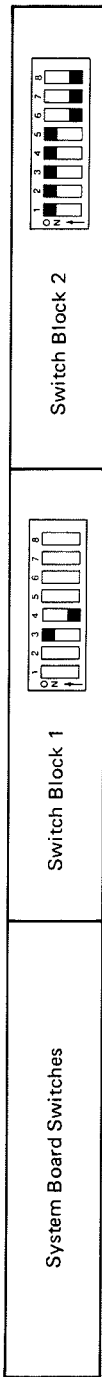



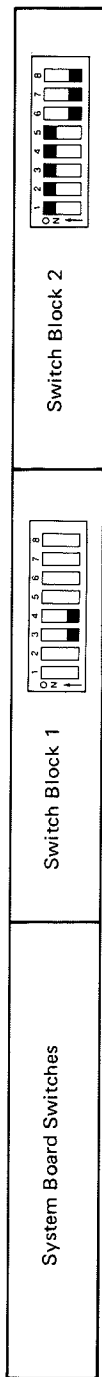

64K Total Memory

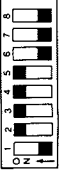



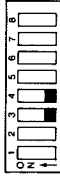
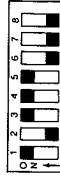

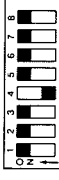
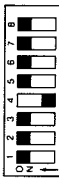
**96K Total Memory
32K + (64K on System Board)**

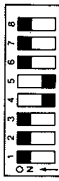
System Board Switches	 <p align="center">Switch Block 1</p>	 <p align="center">Switch Block 2</p>	
1 - 32K option	64/256K Option Card Switches	64K Option Card Switches	32K Option Card Switches



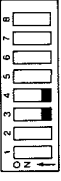
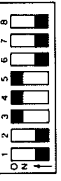

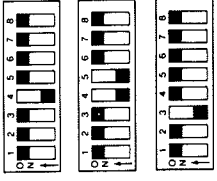

**128K Total Memory
64K + (64K on System Board)**

System Board Switches	Switch Block 1 	Switch Block 2 
1 - 64/256K option with 64K installed	64/256K Option Card Switches 	32K Option Card Switches
1 - 64K option		
2 - 32K options		

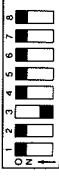

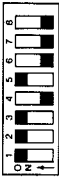

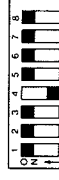
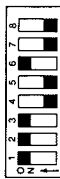
**160K Total Memory
96K + (64K on System Board)**

System Board Switches	Switch Block 1 	Switch Block 2 
1 - 64/256K option with 64K installed 1 - 32K option	64/256K Option Card Switches 	32K Option Card Switches 
1 - 64K option 1 - 32K option		
3 - 32K options		



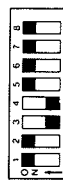

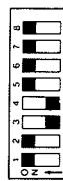
**192K Total Memory
128K + (64K on System Board)**

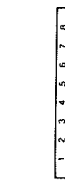
System Board Switches	Switch Block 1	Switch Block 2
1 - 64/256K option with 64K option installed 1 - 64K option		
2 - 64K options		
1 - 64/256K option with 64K installed 2 - 32K options		
1 - 64K option 2 - 32K options		
1 - 64/256K option with 128K installed		

**224K Total Memory
160K + (64K on System Board)**

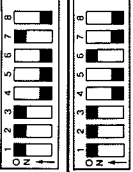
System Board Switches	Switch Block 1	Switch Block 2
<p>1 - 64/256K option with 64K installed 1 - 64K option 1 - 32K option</p>	<p>64/256K Option Card Switches</p> 	<p>32K Option Card Switches</p> 
<p>2 - 64K options 1 - 32K option</p>	<p>64K Option Card Switches</p> 	<p>32K Option Card Switches</p> 
<p>1 - 64/256K option with 128K installed 1 - 32K option</p>	<p>64/256K Option Card Switches</p> 	<p>32K Option Card Switches</p> 

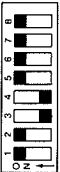
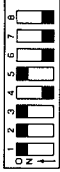
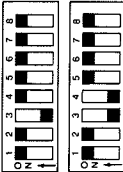
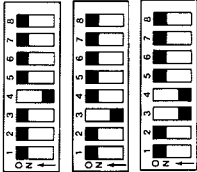

**256K Total Memory
192K + (64K on System Board)**

System Board Switches	Switch Block 1	Switch Block 2
1 - 64/256K option with 192K installed		<p align="center">64K Option Card Switches</p>
1 - 64/256K option with 128K installed 1 - 64K option		
1 - 64/256K option with 64K installed 2 - 64K options		
3 - 64K options		
1 - 64/256K option with 128K installed 2 - 32K options		

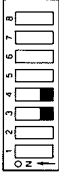
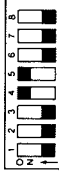
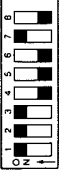
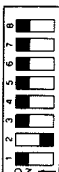

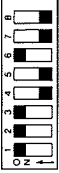

**288K Total Memory
224K + (64K on System Board)**

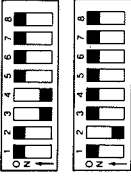
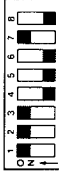
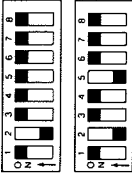
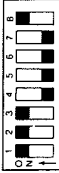
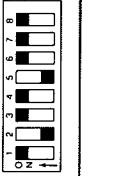
System Board Switches	Switch Block 1	Switch Block 2
1 - 64/256K option with 192K installed 1 - 32K option		
1 - 64/256K option with 128K installed 1 - 64K option 1 - 32K option		











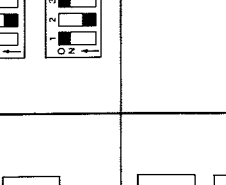

**320K Total Memory
256K + (64K on System Board)**

System Board Switches	Switch Block 1	Switch Block 2
<p>1 - 64/256K option with 128K installed 2 - 64K options</p>	<p>64/256K Option Card Switches</p> 	<p>32K Option Card Switches</p> 
<p>1 - 64/256K option with 192K installed 1 - 64K option</p>	<p>64/256K Option Card Switches</p> 	<p>64K Option Card Switches</p> 
<p>1 - 64/256K option with 192K installed 2 - 32K options</p>	<p>64/256K Option Card Switches</p> 	<p>32K Option Card Switches</p> 
<p>1 - 64/256K option with 256K installed</p>	<p>64/256K Option Card Switches</p> 	<p>32K Option Card Switches</p> 





**352K Total Memory
288K + (64K on System Board)**

System Board Switches	Switch Block 1	Switch Block 2
<ul style="list-style-type: none"> 1 - 64/256K option with 192K installed 1 - 64K option 1 - 32K option 		
<ul style="list-style-type: none"> 1 - 64/256K option with 256K installed 1 - 32K option 		



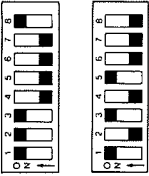

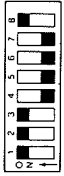

384K Total Memory
320K + (64K on System Board)

System Board Switches	Switch Block 1	Switch Block 2
<p>1 - 64/256K option with 192K installed 2 - 64K options</p>	<p>64/256K Option Card Switches</p> 	<p>64K Option Card Switches</p>  <p>32K Option Card Switches</p> 
<p>1 - 64/256K option with 256K installed 1 - 64/256K option with 64K installed</p>	<p>64/256K Option Card Switches</p> 	<p>64K Option Card Switches</p>  <p>32K Option Card Switches</p> 
<p>1 - 64/256K option with 256K installed 1 - 64K option</p>	<p>64/256K Option Card Switches</p> 	<p>64K Option Card Switches</p>  <p>32K Option Card Switches</p> 
<p>1 - 64/256K option with 256K installed 2 - 32K options</p>	<p>64/256K Option Card Switches</p> 	<p>64K Option Card Switches</p>  <p>32K Option Card Switches</p> 

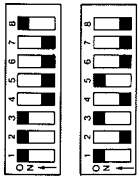

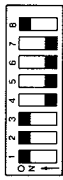
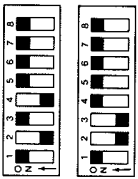
**416K Total Memory
352K + (64K on System Board)**

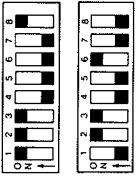
System Board Switches	Switch Block 1	Switch Block 2
<ul style="list-style-type: none"> 1 - 64/256K option with 256K installed 1 - 64/256K option with 64K installed 1 - 32K option 	<p align="center">64/256K Option Card Switches</p> 	<p align="center">64K Option Card Switches</p> 
<ul style="list-style-type: none"> 1 - 64/256K option with 256K installed 1 - 64K option 1 - 32K option 		<p align="center">32K Option Card Switches</p> 



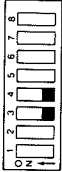
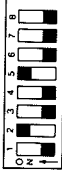
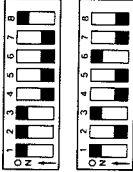

**448K Total Memory
384K + (64K on System Board)**

System Board Switches	Switch Block 1	Switch Block 2				
<p>1 - 64/256K option with 256K installed 1 - 64/256K option with 64K installed 1 - 64K option</p>	<p>64/256K Option Card Switches</p> 	<p>64K Option Card Switches</p> 	<p>32K Option Card Switches</p> 			
<p>1 - 64/256K option with 256K installed 2 - 64K options</p>	<p>64/256K Option Card Switches</p> 	<p>64K Option Card Switches</p> 	<p>32K Option Card Switches</p> 			
<p>1 - 64/256K option with 256K installed 1 - 64/256K option with 128K installed</p>	<p>64/256K Option Card Switches</p> 	<p>64K Option Card Switches</p> 	<p>32K Option Card Switches</p> 			

**480K Total Memory
416K + (64K on System Board)**

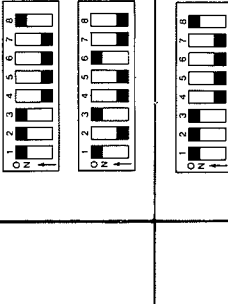
System Board Switches	 <p align="center">Switch Block 1</p>	 <p align="center">Switch Block 2</p>
<p>1 - 64/256K option with 256K installed 1 - 64/256K option with 128K installed 1 - 32K option</p>	<p align="center">64/256K Option Card Switches</p> 	<p align="center">64K Option Card Switches</p>
		<p align="center">32K Option Card Switches</p> 

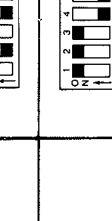

**512K Total Memory
448K + (64K on System Board)**

System Board Switches	Switch Block 1	Switch Block 2
<p>1 - 64/256K option with 256K installed 1 - 64/256K option with 128K installed 1 - 64K option</p>	<p>64/256K Option Card Switches</p> 	<p>64K Option Card Switches</p> 
<p>1 - 64/256K option with 256K installed 1 - 64/256K option with 192K installed</p>	<p>64/256K Option Card Switches</p> 	<p>64K Option Card Switches</p> 

**544K Total Memory
480K + (64K on System Board)**

System Board Switches	<p align="center">Switch Block 1</p>	<p align="center">Switch Block 2</p>
<p>1 - 64/256K option with 256K installed 1 - 64/256K option with 192K installed 1 - 32K option</p>	<p align="center">64/256K Option Card Switches</p>	<p align="center">64K Option Card Switches</p>

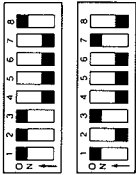
**576K Total Memory
512K + (64K on System Board)**

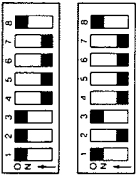
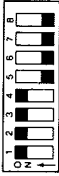
System Board Switches	Switch Block 1	Switch Block 2
<p>1 - 64/256K option with 256K installed 1 - 64/256K option with 192K installed 1 - 64K option</p>	<p align="center">64/256K Option Card Switches</p> 	<p align="center">64K Option Card Switches</p> 
<p>2 - 64/256K option with 256K installed</p>		<p align="center">32K Option Card Switches</p> 



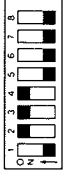
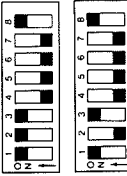
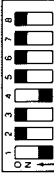



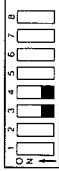
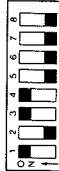
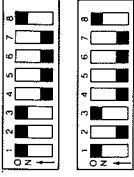
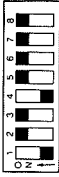
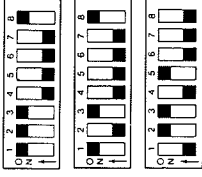

**608K Total Memory
544K + (64K on System Board)**

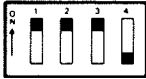
System Board Switches	Switch Block 1 	Switch Block 2 
2 - 64/256K option with 256K installed 1 - 32K option	64/256K Option Card Switches 	64K Option Card Switches
		32K Option Card Switches 

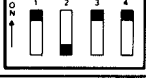
**640K Total Memory
576K + (64K on System Board)**

System Board Switches	Switch Block 1 	Switch Block 2 
2 - 64/256K option with 256K installed 1 - 64K option	64/256K Option Card Switches 	64K Option Card Switches 
2 - 64/256K option with 256K installed 1 - 64/256K option with 64K installed	64/256K Option Card Switches 	32K Option Card Switches

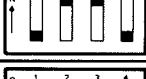
Extender Card Switch Settings

System Memory	Extender Card Switch Block	Memory Segment
16K to 64K		1
96K to 128K		2
160K to 192K		3
224K to 256K		4
288K to 320K		5
352K to 384K		6
416K to 448K		7
480K to 512K		8
544K to 576K		9
608K to 640K		A

Notes:

Switch Settings (64KB-256KB CPU)

System Board Switch Settings	G-31
System Board Switch Settings	G-31
5-1/4" Diskette Drives Switch Settings	G-32
Display Type Switch Settings	G-32
Math Coprocessor Switch Settings	G-32
Memory Option Switch Settings	G-34
64K Total Memory	G-34
128K Total Memory	G-34
192K Total Memory	G-34
256K Total Memory	G-34
288K Total Memory	G-35
320K Total Memory	G-36
352K Total Memory	G-37
384K Total Memory	G-38
416K Total Memory	G-39
448K Total Memory	G-40
480K Total Memory	G-41
512K Total Memory	G-42
544K Total Memory	G-43
576K Total Memory	G-44
608K Total Memory	G-45
640K Total Memory	G-46
Extender Card Switch Settings	G-47

Notes:

Switch Setting Charts

System Board Switches

WARNING: Before you change any switch settings, make a note of how the switches are presently set.

Switch Block 1

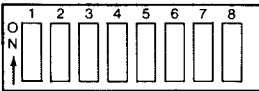

Switch	Function
1,7,8	Number of 5-1/4 inch diskette drives installed
2	Math Coprocessor
3,4	System board memory switches
5,6	Type(s) of display(s) connected

Switch Block 2

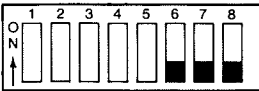

Switch	Function
1,2,3,4,5	Amount of memory options installed
6,7,8	Always in the Off position

Number of 5-1/4 Inch Diskette Drives Installed

	Switch Block 1	Switch Block 2
0 – Drives		
1 – Drive		
2 – Drives		

Type(s) of display(s) connected

WARNING:

If an IBM Monochrome Display is connected to your system. Switch Block 1, switches 5 and 6, must always be Off. Damage to your display can result with any other switch settings.

	Switch Block 1	Switch Block 2	
IBM Monochrome Display (or IBM Monochrome Display plus another display)			
Color Display (Do not use if an IBM Monochrome Display is connected)			40x25 Mode
			80x25 Mode

Note: The 40x25 mode means there will be 40 characters across the screen and 25 lines down the screen. The 80x25 mode means there will be 80 characters across the screen and 25 lines down the screen. The 80x25 mode, when used with home televisions and various displays, can cause loss of character quality.

Math Coprocessor

Switch Block 1

Switch Block 2

With Math Coprocessor

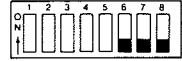
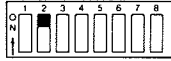

Without Math Coprocessor

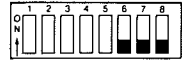
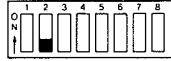

Memory Switch Settings

(64KB-256KB CPU) System Board

64K Total Memory

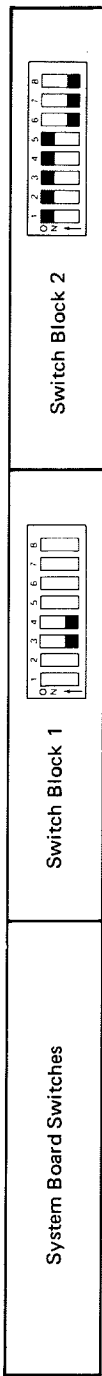

128K Total Memory

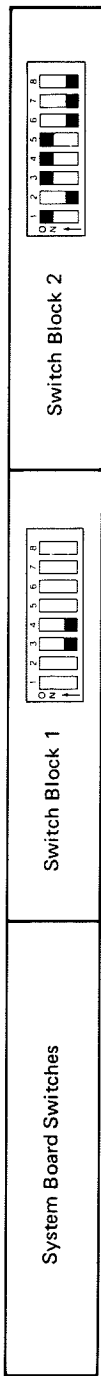

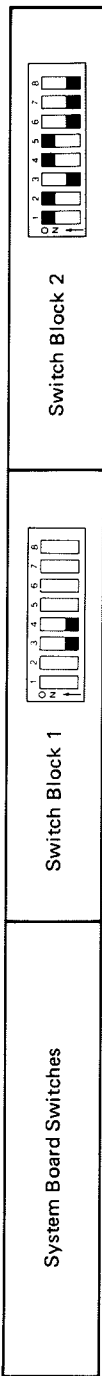

192K Total Memory



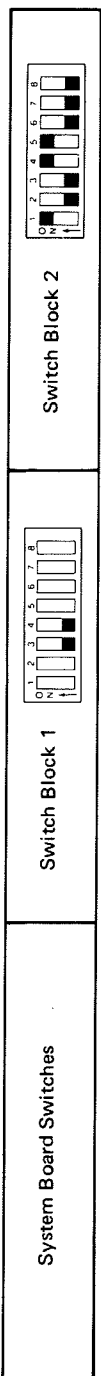

256K Total Memory

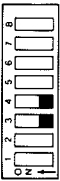



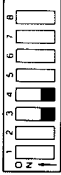

**288K Total Memory
32K + (256K on System Board)**

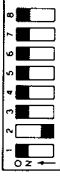
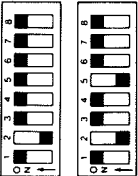
System Board Switches	 <p align="center">Switch Block 1</p>	 <p align="center">Switch Block 2</p>	
1 - 32K option	64/256K Option Card Switches	64K Option Card Switches	32K Option Card Switches

**320K Total Memory
64K + (256K on System Board)**

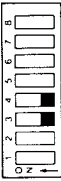
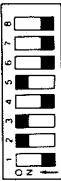





System Board Switches	Switch Block 1	Switch Block 2
1 - 64/256K option with 64K installed		
1 - 64K option		
2 - 32K options		

**352K Total Memory
96K + (256K on System Board)**

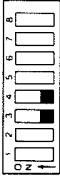
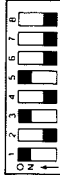

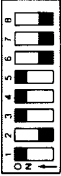
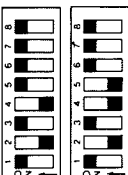

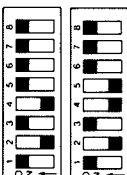
System Board Switches	Switch Block 1	Switch Block 2
<p>1 - 64/256K option with 64K installed 1 - 32K option</p>		
<p>1 - 64K option 1 - 32K option</p>		<p>64K Option Card Switches</p> 
<p>3 - 32K options</p>		<p>32K Option Card Switches</p> 

Appendix G



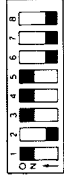

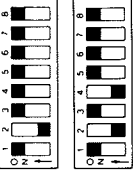
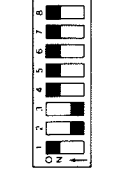

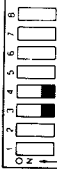

**384K Total Memory
128K + (256K on System Board)**

System Board Switches	Switch Block 1	Switch Block 2
1 - 64/256K option with 64K option installed 1 - 64K option		
2 - 64K options		
1 - 64/256K option with 64K installed 2 - 32K options		
1 - 64K option 2 - 32K options		
1 - 64/256K option with 128K installed		

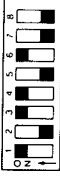
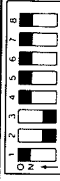
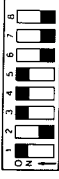
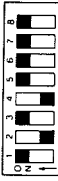

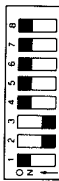
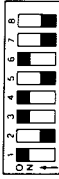
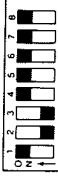

**416K Total Memory
160K + (256K on System Board)**

System Board Switches	Switch Block 1	Switch Block 2
1 - 64/256K option with 64K installed 1 - 64K option 1 - 32K option	64/256K Option Card Switches 	32K Option Card Switches 
2 - 64K options 1 - 32K option	64K Option Card Switches 	
1 - 64/256K option with 128K installed 1 - 32K option		

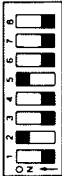
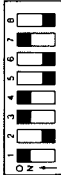

**448K Total Memory
192K + (256K on System Board)**

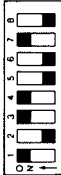
System Board Switches	Switch Block 1 	Switch Block 2 
1 - 64/256K option with 192K installed	64/256K Option Card Switches 	64K Option Card Switches
1 - 64/256K option with 128K installed 1 - 64K option	64/256K Option Card Switches 	64K Option Card Switches 
1 - 64/256K option with 64K installed 2 - 64K options	64/256K Option Card Switches 	64K Option Card Switches  
3 - 64K options	64/256K Option Card Switches	64K Option Card Switches   
1 - 64/256K option with 128K installed 2 - 32K options	64/256K Option Card Switches 	32K Option Card Switches  

**480K Total Memory
224K + (256K on System Board)**

System Board Switches	 <p align="center">Switch Block 1</p>	Switch Block 2	
<p>1 - 64/256K option with 192K installed 1 - 32K option</p>	<p>64/256K Option Card Switches</p>  	64K Option Card Switches	32K Option Card Switches
<p>1 - 64/256K option with 128K installed 1 - 64K option 1 - 32K option</p>	 	64K Option Card Switches	32K Option Card Switches

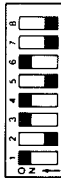
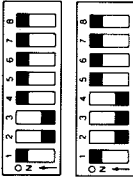

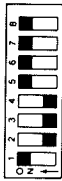
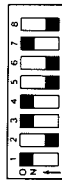
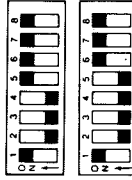
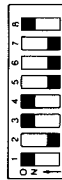



**512K Total Memory
256K + (256K on System Board)**

System Board Switches	Switch Block 1	Switch Block 2
<p>1 - 64/256K option with 128K installed 2 - 64K options</p>	<p>64/256K Option Card Switches</p> 	<p>64K Option Card Switches</p> 
<p>1 - 64/256K option with 192K installed 1 - 64K option</p>	<p>64/256K Option Card Switches</p> 	<p>64K Option Card Switches</p> 
<p>1 - 64/256K option with 192K installed 2 - 32K options</p>	<p>64/256K Option Card Switches</p> 	<p>32K Option Card Switches</p> 
<p>1 - 64/256K option with 256K installed</p>	<p>64/256K Option Card Switches</p> 	

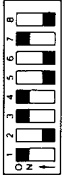

**544K Total Memory
288K + (256K on System Board)**

System Board Switches	Switch Block 1	Switch Block 2
1 - 64/256K option with 192K installed 1 - 64K option 1 - 32K option		
1 - 64/256K option with 256K installed 1 - 32K option		

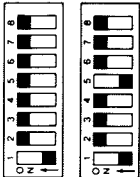
**576K Total Memory
320K + (256K on System Board)**

System Board Switches	Switch Block 1	Switch Block 2
1 - 64/256K option with 192K installed 2 - 64K options		
1 - 64/256K option with 256K installed 1 - 64/256K option with 64K installed		
1 - 64/256K option with 256K installed 1 - 64K option		
1 - 64/256K option with 256K installed 2 - 32K options		

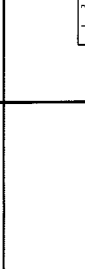





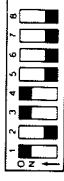
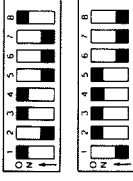
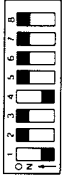
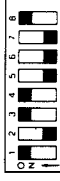
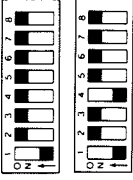
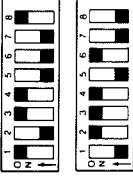

**608K Total Memory
352K + (256K on System Board)**

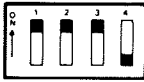
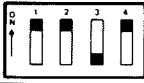
System Board Switches	Switch Block 1	Switch Block 2
<p>1 - 64/256K option with 256K installed 1 - 64/256K option with 64K installed 1 - 32K option</p>		<p>64K Option Card Switches</p>
<p>1 - 64/256K option with 256K installed 1 - 64K option 1 - 32K option</p>		<p>32K Option Card Switches</p>

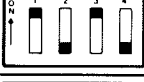
**640K Total Memory
384K + (256K on System Board)**

System Board Switches	Switch Block 1 	Switch Block 2 	
<p>1 - 64/256K option with 256K installed 1 - 64/256K option with 64K installed 1 - 64K option</p>	<p>64/256K Option Card Switches</p> 	<p>64K Option Card Switches</p> 	<p>32K Option Card Switches</p>
<p>1 - 64/256K option with 256K installed 2 - 64K options</p>	<p>64/256K Option Card Switches</p> 	<p>64K Option Card Switches</p> 	
<p>1 - 64/256K option with 256K installed 1 - 64/256K option with 128K installed</p>	<p>64/256K Option Card Switches</p> 		

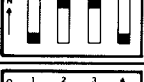
Extender Card Switch Settings

System Memory	Extender Card Switch Block	Memory Segment
16K to 64K		1
96K to 128K		2
160K to 192K		3
224K to 256K		4
288K to 320K		5
352K to 384K		6
416K to 448K		7
480K to 512K		8
544K to 576K		9
608K to 640K		A

Notes:

GLOSSARY

μs: Microsecond.

adapter: An auxiliary system or unit used to extend the operation of another system.

address bus: One or more conductors used to carry the binary-coded address from the microprocessor throughout the rest of the system.

all points addressable (APA): A mode in which all points on a displayable image can be controlled by the user.

alphanumeric (A/N): Pertaining to a character set that contains letters, digits, and usually other characters, such as punctuation marks. Synonymous with alphanumeric.

American Standard Code for Information Interchange (ASCII): The standard code, using a coded character set consisting of 7-bit coded characters (8 bits including parity check), used for information interchange among data processing systems, data communication systems and associated equipment. The ASCII set consists of control characters and graphic characters.

A/N: Alphanumeric.

analog: (1) pertaining to data in the form of continuously variable physical quantities. (2) Contrast with digital.

AND: A logic operator having the property that if P is a statement, Q is a statement, R is a statement,...,then the AND of P, Q, R,...is true if all statements are true, false if any statement is false.

APA: All points addressable.

ASCII: American Standard Code for Information Interchange.

assembler: A computer program used to assemble. Synonymous with assembly program.

asynchronous communications: A communication mode in which each single byte of data is synchronized, usually by the addition of start/stop bits.

BASIC: Beginner's all-purpose symbolic instruction code.

basic input/output system (BIOS): Provides the device level control of the major I/O devices in a computer system, which provides an operational interface to the system and relieves the programmer from concern over hardware device characteristics.

baud: (1) A unit of signaling speed equal to the number of discrete conditions or signal events per second. For example, one baud equals one-half dot cycle per second in Morse code, one bit per second in a train of binary signals, and one 3-bit value per second in a train of signals each of which can assume one of eight different states. (2) In asynchronous transmission, the unit of modulation rate corresponding to one unit of interval per second; that is, if the duration of the unit interval is 20 milliseconds, the modulation rate is 50 baud.

BCC: Block-check character.

beginner's all-purpose symbolic instruction code (BASIC): A programming language with a small repertoire of commands and a simple syntax, primarily designed for numerical application.

binary: (1) Pertaining to a selection, choice, or condition that has two possible values or states. (2) Pertaining to a fixed radix numeration system having a radix of two.

binary digit: (1) In binary notation, either of the characters 0 or 1. (2) Synonymous with bit.

binary notation: Any notation that uses two different characters, usually the binary digits 0 and 1.

binary synchronous communications (BSC): A standardized procedure, using a set of control characters and control character sequences for synchronous transmission of binary-coded data between stations.

BIOS: Basic input/output system.

bit: In binary notation, either of the characters 0 or 1.

bits per second (bps): A unit of measurement representing the number of discrete binary digits which can be transmitted by a device in one second.

block-check character (BCC): In cyclic redundancy checking, a character that is transmitted by the sender after each message block and is compared with a block-check character computed by the receiver to determine if the transmission was successful.

boolean operation: (1) Any operation in which each of the operands and the result take one of two values. (2) An operation that follows the rules of boolean algebra.

bootstrap: A technique or device designed to bring itself into a desired state by means of its own action; that is, a machine routine whose first few instructions are sufficient to bring the rest of itself into the computer from an input device.

bps: Bits per second.

BSC: Binary synchronous communications.

buffer: (1) An area of storage that is temporarily reserved for use in performing an input/output operation, into which data is read or from which data is written. Synonymous with I/O area. (2) A portion of storage for temporarily holding input or output data.

bus: One or more conductors used for transmitting signals or power.

byte: (1) A binary character operated upon as a unit and usually shorter than a computer word. (2) The representation of a character.

CAS: Column address strobe.

cathode ray tube (CRT): A vacuum tube display in which a beam of electrons can be controlled to form alphanumeric characters or symbols on a luminescent screen, for example by use of a dot matrix.

cathode ray tube display (CRT display): (1) A device that presents data in visual form by means of controlled electron beams. (2) The data display produced by the device as in (1).

CCITT: Comite Consultatif International Telegraphique et Telephonique.

central processing unit (CPU): A functional unit that consists of one or more processors and all or part of internal storage.

channel: A path along which signals can be sent; for example, data channel or I/O channel.

characters per second (cps): A standard unit of measurement for printer output.

code: (1) A set of unambiguous rules specifying the manner in which data may be represented in a discrete form. Synonymous with coding scheme. (2) A set of items, such as abbreviations, representing the members of another set. (3) Loosely, one or more computer programs, or part of a computer program. (4) To represent data or a computer program in a symbolic form that can be accepted by a data processor.

column address strobe (CAS): A signal that latches the column addresses in a memory chip.

Comite Consultatif International Telegraphique et Telephonique (CCITT): Consultative Committee on International Telegraphy and Telephony.

computer: A functional unit that can perform substantial computation, including numerous arithmetic operations, or logic operations, without intervention by a human operator during the run.

configuration: (1) The arrangement of a computer system or network as defined by the nature, number, and the chief characteristics of its functional units. More specifically, the term configuration may refer to a hardware configuration or a software configuration. (2) The devices and programs that make up a system, subsystem, or network.

conjunction: (1) The boolean operation whose result has the boolean value 1 if, and only if, each operand has the boolean value 1. (2) Synonymous with AND operation.

contiguous: (1) Touching or joining at the edge or boundary. (2) Adjacent.

CPS: Characters per second.

CPU: Central processing unit.

CRC: Cyclic redundancy check.

CRT: Cathode ray tube.

CRT display: Cathode ray tube display.

CTS: Clear to send. Associated with modem control.

cyclic redundancy check (CRC): (1) A redundancy check in which the check key is generated by a cyclic algorithm. (2) A system of error checking performed at both the sending and receiving station after a block-check character has been accumulated.

cylinder: (1) The set of all tracks with the same nominal distance from the axis about which the disk rotates. (2) The tracks of a disk storage device that can be accessed without repositioning the access mechanism.

daisy-chained cable: A type of cable that has two or more connectors attached in series.

data: (1) A representation of facts, concepts, or instructions in a formalized manner suitable for communication, interpretation, or processing by humans or automatic means. (2) Any representations, such as characters or analog quantities, to which meaning is, or might be assigned.

decoupling capacitor: A capacitor that provides a low-impedance path to ground to prevent common coupling between states of a circuit.

Deutsche Industrie Norm (DIN): (1) German Industrial Norm. (2) The committee that sets German dimension standards.

digit: (1) A graphic character that represents an integer, for example, one of the characters 0 to 9. (2) A symbol that represents one of the non-negative integers smaller than the radix. For example, in decimal notation, a digit is one of the characters from 0 to 9.

digital: (1) Pertaining to data in the form of digits. (2) Contrast with analog.

DIN: Deutsche Industrie Norm.

DIN connector: One of the connectors specified by the DIN standardization committee.

DIP: Dual in-line package.

direct memory access (DMA): A method of transferring data between main storage and I/O devices that does not require processor intervention.

disk: Loosely, a magnetic disk unit.

diskette: A thin, flexible magnetic disk and a semi-rigid protective jacket, in which the disk is permanently enclosed. Synonymous with flexible disk.

DMA: Direct memory access.

DSR: Data set ready. Associated with modem control.

DTR: Data terminal ready. Associated with modem control.

dual in-line package (DIP): A widely used container for an integrated circuit. DIPs are pins usually in two parallel rows. These pins are spaced 1/10 inch apart and come in different configurations ranging from 14-pin to 40-pin configurations.

EBCDIC: Extended binary-coded decimal interchange code.

ECC: Error checking and correction.

edge connector: A terminal block with a number of contacts attached to the edge of a printed circuit board to facilitate plugging into a foundation circuit.

EIA: Electronic Industries Association.

EIA/CCITT: Electronics Industries Association/Consultative Committee on International Telegraphy and Telephony.

end-of-text-character (ETX): A transmission control character used to terminate text.

end-of-transmission character (EOT): A transmission control character used to indicate the conclusion of a transmission, which may have included one or more texts and any associated message headings.

EOT: End-of-transmission character.

EPROM: Erasable programmable read-only memory.

erasable programmable read-only memory (EPROM): A storage device whose contents can be changed by electrical means. EPROM information is not destroyed when power is removed.

error checking and correction (ECC): The detection and correction of all single-bit, double-bit, and some multiple-bit errors.

ETX: End-of-text character.

extended binary-coded decimal interchange code (EBCDIC): A set of 256 characters, each represented by eight bits.

flexible disk: Synonym for diskette.

firmware: Memory chips with integrated programs already incorporated on the chip.

gate: (1) A device or circuit that has no output until it is triggered into operation by one or more enabling signals, or until an input signal exceeds a predetermined threshold amplitude. (2) A signal that triggers the passage of other signals through a circuit.

graphic: A symbol produced by a process such as handwriting, drawing, or printing.

hertz (Hz): A unit of frequency equal to one cycle per second.

hex: Abbreviation for hexadecimal.

hexadecimal: Pertaining to a selection, choice, or condition that has 16 possible values or states. These values or states usually contain 10 digits and 6 letters, A through F. Hexadecimal digits are equivalent to a power of 16.

high-order position: The leftmost position in a string of characters.

Hz: Hertz.

interface: A device that alters or converts actual electrical signals between distinct devices, programs, or systems.

k: An abbreviation for the prefix kilo; that is, 1,000 in decimal notation.

K: When referring to storage capacity, 2 to the tenth power; 1,024 in decimal notation.

KB: Kilobyte; 1,024 bytes.

kHz: A unit of frequency equal to 1,000 hertz.

kilo (k): One thousand.

latch: (1) A feedback loop in symmetrical digital circuits used to maintain a state. (2) A simple logic-circuit storage element comprising two gates as a unit.

LED: Light-emitting diode.

light-emitting diode (LED): A semi-conductor chip that gives off visible or infrared light when activated.

low-order position: The rightmost position in a string of characters.

m: (1) Milli; one thousand or thousandth part. (2) Meter.

M: Mega; 1,000,000 in decimal notation. When referring to storage capacity, 2 to the twentieth power; 1,048,576 in decimal notation.

mA: Milliampere.

machine language: (1) A language that is used directly by a machine. (2) Another term for computer instruction code.

main storage: A storage device in which the access time is effectively independent of the location of the data.

MB: Megabyte, 1,048,576 bytes.

mega (M): 10 to the sixth power, 1,000,000 in decimal notation. When referring to storage capacity, 2 to the twentieth power, 1,048,576 in decimal notation.

megabyte (MB): 1,048,576 bytes.

megahertz (MHz): A unit of measure of frequency. 1 megahertz equals 1,000,000 hertz.

MFM: Modified frequency modulation.

MHz: Megahertz.

microprocessor: An integrated circuit that accepts coded instructions for execution; the instructions may be entered, integrated, or stored internally.

microsecond (μ s): One-millionth of a second.

milli (m): One thousand or one thousandth.

milliampere (mA): One thousandth of an ampere.

millisecond (ms): One thousandth of a second.

mnemonic: A symbol chosen to assist the human memory; for example, an abbreviation such a “mpy” for “multiply.”

mode: (1) A method of operation; for example, the binary mode, the interpretive mode, the alphanumeric mode. (2) The most frequency value in the statistical sense.

modem: (Modulator-Demodulator) A device that converts serial (bit by bit) digital signals from a business machine (or data terminal equipment) to analog signals which are suitable for transmission in a telephone network. The inverse function is also performed by the modem on reception of analog signals.

modified frequency modulation (MFM): The process of varying the amplitude and frequency of the “write” signal. MFM pertains to the number of bytes of storage that can be stored on the recording media. The number of bytes is twice the number contained in the same unit area of recording media at single density.

modulo check: A calculation performed on values entered into a system. This calculation is designed to detect errors.

monitor: (1) A device that observes and verifies the operation of a data processing system and indicates any specific departure from the norm. (2) A television type display, such as the IBM Monochrome Display. (3) Software or hardware that observes, supervises, controls, or verifies the operations of a system.

ms: Millisecond; one thousandth of a second.

multiplexer: A device capable of interleaving the events of two or more activities, or capable of distributing the events of an interleaved sequence to the respective activities.

NAND: A logic operator having the property that if P is a statement, Q is a statement, R is a statement,....,then the NAND of P,Q,R,...is true if at least one statement is false, false if all statements are true.

nanosecond (ns): One-thousandth-millionth of a second.

nonconjunction: The dyadic boolean operation the result of which has the boolean value 0 if, and only if, each operand has the boolean value 1.

non-return-to-zero inverted (NRZI): A transmission encoding method in which the data terminal equipment changes the signal to the opposite state to send a binary 0 and leaves it in the same state to send a binary 1.

NOR: A logic operator having the property that if P is a statement, Q is a statement, R is a statement,...,then the NOR of P,Q,R,...is true if all statements are false, false if at least one statement is true.

NOT: A logical operator having the property that if P is a statement, then the NOT of P is true if P is false, false if P is true.

NRZI: Non-return-to-zero inverted.

ns: Nanosecond; one-thousandth-millionth of a second.

operating system: Software that controls the execution of programs; an operating system may provide services such as resource allocation, scheduling, input/output control, and data management.

OR: A logic operator having the property that if P is a statement, Q is a statement, R is a statement,...,then the OR of P,Q,R,...is true if at least one statement is true, false if all statements are false.

output: Pertaining to a device, process, or channel involved in an output process, or to the data or states involved in an output process.

output process: (1) The process that consists of the delivery of data from a data processing system, or from any part of it. (2) The return of information from a data processing system to an end user, including the translation of data from a machine language to a language that the end user can understand.

overcurrent: A current of higher than specified strength.

overvoltage: A voltage of higher than specified value.

parallel: (1) Pertaining to the concurrent or simultaneous operation of two or more devices, or to the concurrent performance of two or more activities. (2) Pertaining to the concurrent or simultaneous occurrence of two or more related activities in multiple devices or channels. (3) Pertaining to the simultaneity of two or more processes. (4) Pertaining to the simultaneous processing of the individual parts of a whole, such as the bits of a character and the characters of a word, using separate facilities for the various parts. (5) Contrast with serial.

PEL: Picture element.

personal computer: A small home or business computer that has a processor and keyboard that can be connected to a television or some other monitor. An optional printer is usually available.

picture element (PEL): (1) The smallest displayable unit on a display. (2) Synonymous with pixel, PEL.

pinout: A diagram of functioning pins on a pinboard.

pixel: Picture element.

polling: (1) Interrogation of devices for purposes such as to avoid contention, to determine operational status, or to determine readiness to send or receive data. (2) The process whereby stations are invited, one at a time, to transmit.

port: An access point for data entry or exit.

printed circuit board: A piece of material, usually fiberglass, that contains a layer of conductive material, usually metal. Miniature electronic components on the fiberglass transmit electronic signals through the board by way of the metal layers.

program: (1) A series of actions designed to achieve a certain result. (2) A series of instructions telling the computer how to handle a problem or task. (3) To design, write, and test computer programs.

programming language: (1) An artificial language established for expressing computer programs. (2) A set of characters and rules, with meanings assigned prior to their use, for writing computer programs.

PROM: Programmable read-only memory.

propagation delay: The time necessary for a signal to travel from one point on a circuit to another.

radix: (1) In a radix numeration system, the positive integer by which the weight of the digit place is multiplied to obtain the weight of the digit place with the next higher weight; for example, in the decimal numeration system, the radix of each digit place is 10. (2) Another term for base.

radix numeration system: A positional representation system in which the ratio of the weight of any one digit place to the weight of the digit place with the next lower weight is a positive integer. The permissible values of the character in any digit place range from zero to one less than the radix of the digit place.

RAS: Row address strobe.

RGBI: Red-green-blue-intensity.

read-only memory (ROM): A storage device whose contents cannot be modified, except by a particular user, or when operating under particular conditions; for example, a storage device in which writing is prevented by a lockout.

read/write memory: A storage device whose contents can be modified.

red-green-blue-intensity (RGBI): The description of a direct-drive color monitor which accepts red, green, blue, and intensity signal inputs.

register: (1) A storage device, having a specified storage capacity such as a bit, a byte, or a computer word, and usually intended for a special purpose. (2) On a calculator, a storage device in which specific data is stored.

RF modulator: The device used to convert the composite video signal to the antenna level input of a home TV.

ROM: Read-only memory.

ROM/BIOS: The ROM resident basic input/output system, which provides the device level control of the major I/O devices in the computer system.

row address strobe (RAS): A signal that latches the row addresses in a memory chip.

RS-232C: The standard set by the EIA for communications between computers and external equipment.

RTS: Request to send. Associated with modem control.

run: A single continuous performance of a computer program or routine.

scan line: The use of a cathode beam to test the cathode ray tube of a display used with a personal computer.

schematic: The description, usually in diagram form, of the logical and physical structure of an entire data base according to a conceptual model.

SDLC: Synchronous Data Link Control.

sector: That part of a track or band on a magnetic drum, a magnetic disk, or a disk pack that can be accessed by the magnetic heads in the course of a predetermined rotational displacement of the particular device.

serdes: Serializer/deserializer.

serial: (1) Pertaining to the sequential performance of two or more activities in a single device. In English, the modifiers serial and parallel usually refer to devices, as opposed to sequential and consecutive, which refer to processes. (2) Pertaining to the sequential or consecutive occurrence of two or more related activities in a single device or channel. (3) Pertaining to the sequential processing of the individual parts of a whole, such as the bits of a character or the characters of a word, using the same facilities for successive parts. (4) Contrast with parallel.

sink: A device or circuit into which current drains.

software: (1) Computer programs, procedures, rules, and possibly associated documentation concerned with the operation of a data processing system. (2) Contrast with hardware.

source: The origin of a signal or electrical energy.

source circuit: (1) Generator circuit. (2) Control with sink.

SS: Start-stop transmission.

start bit: Synonym for start signal.

start-of-text character (STX): A transmission control character that precedes a text and may be used to terminate the message heading.

start signal: (1) A signal to a receiving mechanism to get ready to receive data or perform a function. (2) In a start-stop system, a signal preceding a character or block that prepares the receiving device for the reception of the code elements. Synonymous with start bit.

start-stop (SS) transmission: Asynchronous transmission such that a group of signals representing a character is preceded by a start signal and followed by a stop signal. (2) Asynchronous transmission in which a group of bits is preceded by a start bit that prepares the receiving mechanism for the reception and registration of a character and is followed by at least one stop bit that enables the receiving mechanism to come to an idle condition pending the reception of the next character.

stop bit: Synonym for stop signal.

stop signal: (1) A signal to a receiving mechanism to wait for the next signal. (2) In a start-stop system, a signal following a character or block that prepares the receiving device for the reception of a subsequent character or block. Synonymous with stop bit.

stroke: (1) An instrument used to determine the exact speed of circular or cyclic movement. (2) A flashing signal displaying an exact event.

STX: Start-of-text character.

Synchronous Data Link Control (SLDC): A protocol for the management of data transfer over a data communications link.

synchronous transmission: Data transmission in which the sending and receiving devices are operating continuously at the same frequency and are maintained, by means of correction, in a desired phase relationship.

text: In ASCII and data communication, a sequence of characters treated as an entity if preceded and terminated by one STX and one ETX transmission control, respectively.

track: (1) The path or one of the set of paths, parallel to the reference edge on a data medium, associated with a single reading or writing component as the data medium moves past the component. (2) The portion of a moving data medium such as a drum, tape, or disk, that is accessible to a given reading head position.

transistor-transistor logic (TTL): A circuit in which the multiple-diode cluster of the diode-transistor logic circuit has been replaced by a multiple-emitter transistor.

TTL: Transistor-transistor logic.

TX Data: Transmit data. Associated with modem control. External connections of the RS-232C asynchronous communications adapter interface.

video: Computer data or graphics displayed on a cathode ray tube, monitor or display.

write precompensation: The varying of the timing of the head current from the outer tracks to the inner tracks of the diskette to keep a constant write signal.

BIBLIOGRAPHY

Intel Corporation. *The 8086 Family User's Manual*

This manual introduces the 8086 family of microcomputing components and serves as a reference in system design and implementation.

Intel Corporation. *8086/8087/8088 Macro Assembly Reference Manual for 8088/8085 Based Development System*

This manual describes the 8086/8087/8088 Macro Assembly Language, and is intended for use by persons who are familiar with assembly language.

Intel Corporation. *Component Data Catalog*

This book describes Intel components and their technical specifications.

Motorola, Inc. *The Complete Microcomputer Data Library.*

This book describes Motorola components and their technical specifications.

National Semiconductor Corporation. *INS 8250 Asynchronous Communications Element.* This book documents physical and operating characteristics of the INS 8250.

Notes:

INDEX

A

- A/N mode (alphanumeric mode) 1-131
- A0-A19 (Address Bits 0 to 19), I/O channel 1-18
- adapter card with ROM 2-10
- adapter,
 - asynchronous communication 1-223
 - binary synchronous communication 1-251
 - color/graphics monitor 1-131
 - diskette drive 1-159
 - fixed disk drive 1-187
 - game control 1-211
 - monochrome display and printer 1-129
 - printer 1-117
 - synchronous data link control 1-271
- Address Bits 0 to 19 (A0-A19), I/O channel 1-131
- Address Bits (asynchronous communication) 1-225
- Address Enable (AEN), I/O channel 1-22
- Address Latch Enable (ALE), I/O channel 1-20
- address map, I/O 1-10
- AEN (Address Enable), I/O channel 1-22
- ALE (Address Latch Enable), I/O channel 1-20
- all points addressable mode 1-129, 1-132
- alphanumeric mode, 1-136
 - high resolution 1-137
 - low resolution 1-137
- alt (keyboard extended code) 2-15
- APA mode (all points addressable mode) 1-131, 1-132
- asynchronous communications adapter, 1-223
 - adapter address jumper module 1-249
 - address bits 1-225
 - block diagram 1-224
 - connector specifications 1-250
 - current loop interface 1-227
 - divisor latch least significant bit 1-237
 - divisor latch most significant bit 1-238
 - I/O decode 1-225
 - INS8250 functional pin description 1-229
 - INS8250 input signals 1-229
 - INS8250 input/output signals 1-233
 - INS8250 output signals 1-232
 - interface descriptions 1-226
 - interface format jumper module 1-249

- interrupt control functions 1-237
- interrupt enable register 1-243
- interrupt identification register 1-240
- interrupts 1-226
- line control register 1-235
- line status register 1-239
- modem control register 1-244
- modem status register 1-246
- modes of operation 1-224
- programmable baud rate generator 1-237
- programming considerations 1-234
- receiver buffer register 1-247
- reset functions 1-230
- transmitter holding register 1-248
- voltage interchange information 1-228
- attributes, character
 - (see character attributes)

B

- BASIC reserved interrupts 2-7
- BASIC,
 - DEF SEG 2-8
 - reserved interrupt 2-7
 - screen editor keyboard functions 2-20
 - workspace variables 2-8
- baud rate generator 1-237
- bell (printer) 1-102
- bibliography I-1
- binary synchronous communications adapter, 1-251
 - 8251A programming procedures 1-262
 - 8251A universal synchronous/asynchronous receiver/transmitter 1-252
 - 8253-5 programmable interval timer 1-257
 - 8255A-5 programmable peripheral interface 1-256
- block diagram 1-252
- command instruction format 1-264
- connector information 1-269
- data bus buffer 1-253
- interface signal information 1-266
- interrupt information 1-268
- mode instruction definition 1-263
- read/write control logic 1-253
- receive 1-258

- receiver buffer 1-255
- receiver control 1-255
- status read definition 1-265
- transmit 1-265
- transmitter buffer 1-254
- transmitter control 1-255
- typical programming sequence 1-259

BIOS,

- cassette logic (see cassette logic BIOS)
- fixed disk ROM A-87
- memory map 2-9
- parameter passing 2-3
- software interrupt listing 2-4
- system ROM A-2
- use of 2-2

bisync communications

(see binary synchronous communications)

block diagram

- 8251A universal synchronous/asynchronous receiver/transmitter 1-252
- 8273 SDLC protocol controller 1-272
- asynchronous communications adapter 1-224
- cassette circuits 1-29
- color/graphics monitor adapter 1-134
- coprocessor 1-37
- diskette drive adapter 1-160
- expansion board 1-80
- extender card 1-87
- fixed disk drive adapter 1-188
- game control adapter 1-211
- keyboard interface 1-75
- monochrome display adapter 1-124
- printer adapter 1-118
- prototype card 1-218
- receiver card 1-89
- speaker drive system 1-24
- synchronous data link control adapter 1-271
- system 1-2

break (keyboard extended code) 2-17

BSC adapter

(see binary synchronous communications)

C

- cable
 - communications adapter 1-301
 - expansion unit 1-79
 - printer 1-91
- cancel (printer) 1-103
- cancel ignore paper end (printer) 1-103
- cancel skip perforation (printer) 1-109
- caps lock (keyboard extended code) 2-16
- card dimensions and specifications E-4
- card,
 - dimensions and specifications E-4
 - extender 1-85
 - prototype 1-217
 - receiver 1-88
- carriage return (printer) 1-102
- cassette circuit block diagram
 - motor control 1-30
 - read hardware 1-29
 - write hardware 1-29
- cassette interface, 1-28
 - connector specifications 1-31
- cassette logic,
 - BIOS 2-21
 - cassette read 2-23
 - cassette write 2-22
 - data record architecture 2-24
 - data record components 2-24
 - error recovery 2-24
 - interrupt 2-21
 - software algorithms 2-28
- cassette read 2-23
- cassette ROM BIOS 2-21
- cassette write 2-22
- CCITT, F-1
 - standards F-1
- character attributes
 - color/graphics monitor adapter 1-140
 - monochrome display adapter 1-140
- character codes
 - keyboard 2-11

- character set,
 - graphics printer (set 1) 1-113
 - graphics printer (set 2) 1-115
 - matrix printer 1-111
 - quick reference C-12
- clear printer buffer (printer) 1-110
- CLK (system clock), I/O channel 1-19
- color display 1-157
 - operating characteristics 1-157
 - specifications E-2
- color select register 1-149
- color/graphics monitor adapter 1-131
 - 6845 register description 1-148
 - alphanumeric mode 1-136
 - alphanumeric mode (high-resolution) 1-144
 - alphanumeric mode (low-resolution) 1-142
 - block diagram 1-134
 - character attributes 1-140
 - color-select register 1-149
 - composite connector specifications 1-155
 - connector specifications 1-156
 - direct-drive connector specifications 1-155
 - display buffer basic operation 1-145
 - graphics mode 1-141
 - graphics mode (high resolution) 1-144
 - graphics mode (low resolution) 1-142
 - graphic mode (medium resolution) 1-142
 - light pen connector specifications 1-156
 - major components 1-135
 - memory requirements 1-154
 - mode control and status register 1-149
 - mode register summary 1-152
 - mode select register 1-151
 - programming considerations 1-147
 - RF modulator connector specifications 1-156
 - sequence of events 1-153
 - status register 1-153
 - summary of available colors 1-146
- colors, summary of available 1-146
- command status register 0 1-172
- command status register 1 1-173
- command status register 2 1-174
- command status register 3 1-175

- command summary,
 - diskette drive adapter 1-166
 - fixed disk drive adapter 1-195
- communications adapter cable 1-301
 - connector specifications 1-302
- communications F-1
 - establishing a link F-3
- component diagram,
 - system board 1-7
- compressed (printer) 1-103
- compressed off (printer) 1-103
- connector specifications,
 - asynchronous communications adapter 1-250
 - binary synchronous communications 1-269
 - cassette interface 1-31
 - color/graphics monitor adapter 1-155
 - communications adapter cable 1-302
 - diskette drive adapter (external) 1-182
 - diskette drive adapter (internal) 1-181
 - game control adapter 1-216
 - keyboard interface 1-78
 - monochrome display adapter 1-128
 - printer adapter 1-122
 - synchronous data link control adapter 1-299
- connectors,
 - power supply (system unit) 1-26
 - power supply (expansion unit) 1-83
- considerations, programming
 - (see programming considerations)
- control byte, fixed disk drive adapter 1-194
- control codes, printer 1-101
- control/read/write logic 1-274
- coprocessor,
 - (see math coprocessor)
- ctrl (keyboard extended code) 2-15
- current loop interface 1-227

D

- D0-D7 (data bits 0 to 7), I/O channel 1-18
- DACK0-DACK3 (DMA Acknowledge 0 to 3), I/O channel 1-21
- Data Bits 0 to 7 (D0-D7), I/O channel 1-18
- data flow,
 - system board 1-8

- data record architecture, cassette 2-24
- data record components, cassette 2-24
- data register 1-193
- data transfer mode register 1-288
- DEF SEG (default segment workspace) 2-8
- default workspace segment (DEF SEG) 2-8
- diagram, block (see block diagram)
- digital output register 1-161
- diskette drive adapter 1-159
 - adapter input 1-179
 - adapter output 1-178
 - block diagram 1-160
 - command status register 0 1-172
 - command status register 1 1-173
 - command status register 2 1-174
 - command status register 3 1-175
 - command summary 1-166
 - connector specifications (external) 1-182
 - connector specifications (internal) 1-181
 - digital-output register 1-161
 - DPC registers 1-174
 - drive A and B interface 1-178
 - drive constants 1-176
 - FDC constants 1-176
 - floppy disk controller 1-162
 - functional description 1-161
 - programming considerations 1-164
 - programming summary 1-175
 - symbol descriptions 1-164
 - system I/O channel interface 1-176
- diskette drive, 1-183
 - electrical specifications 1-184
 - mechanical specifications 1-184
 - switch settings G-1
- diskettes 1-185
- display adapter type switch settings G-1
- display,
 - color 1-157
 - monochrome 1-123
- divisor latch,
 - least significant bit 1-237
 - most significant bit 1-238
- DMA Acknowledge 0 to 3 (DACK0-DACK3),
 - I/O channel 1-21

- DMA Request 1 to 3 (DRQ1-DRQ3), I/O channel 1-21
- DOS reserved interrupts 2-9
- DOS,
 - keyboard functions 2-21
 - reserved interrupts 2-9
- double strike (printer) 1-106
- double strike off (printer) 1-107
- double width (printer) 1-99, 1-103
- double width off (printer) 1-103
- DPC registers 1-175
- DRQ1-DRQ3 (DMA Request 1 to 3), I/O channel 1-21

E

- EIA, F-1
 - standards F-1
- emphasized (printer) 1-106
- emphasized off (printer) 1-106
- error recovery, cassette 2-24
- escape (printer) 1-104
- establishing a communications link F-3
- expansion board, 1-79
 - block diagram 1-80
- expansion channel 1-81
- expansion unit, 1-79
 - cable 1-79
 - expansion board 1-79
 - expansion channel 1-81
 - extender card 1-85
 - interface information 1-90
 - power supply 1-83
 - power supply connectors 1-83
 - receiver card 1-88
 - specifications E-2
- extender card, 1-85
 - block diagram 1-87
 - programming considerations 1-86
 - switch settings G-1

F

- FABS 1-44
- FADD 1-43
- FBLD 1-45
- FBSTP 1-46
- FCBS 1-46
- FCLEX/FNCLEX 1-46
- FCOM 1-47
- FCOMP 1-47
- FCOMPP 1-48
- FDECSTP 1-48
- FDISI/FNDISI 1-48
- FDIV 1-49
- FDIVR 1-50
- FENI/FNENI 1-51
- FFREE 1-51
- FICOM 1-51
- FICOMP 1-52
- FILD 1-52
- FINCSTP 1-52
- FINIT/FNINIT 1-53
- FIST 1-54
- FISTP 1-54
- fixed disk controller 1-185
- fixed disk drive 1-201
- fixed disk drive adapter 1-185
 - block diagram 1-186
 - command summary 1-193
 - control byte 1-192
 - data register 1-191
 - fixed disk controller 1-185
 - interface specifications 1-200
 - programming considerations 1-187
 - programming summary 1-197
 - ROM BIOS listing A-87
 - sense bytes 1-187
 - status register 1-187
 - system I/O channel interface 1-198
- fixed disk drive, 1-201
 - electrical specifications 1-202
 - mechanical specifications 1-202

fixed disk ROM BIOS A-87

FLD 1-55

FLDCW 1-55

FLDENV 1-56

FLDLG2 1-56

FLDLN2 1-56

FLDL2E 1-57

FLDL2T 1-57

FLDPI 1-57

FLDZ 1-58

FLD1 1-58

floppy disk controller 1-160

FMUL 1-59

FNOP 1-60

FPATAN 1-60

FPREM 1-60

FPTAN 1-61

FRNDINT 1-61

FRSTOR 1-61

form feed (printer) 1-102

FSAVE/FNSAVE 1-62

FSCALE 1-62

FSQRT 1-62

FST 1-63

FSTCW/FNSTCW 1-63

FSTENV/FNSTENV 1-64

FSTP 1-64

FSTSW/FNSTSW 1-65

FSUB 1-65

FSUBR 1-66

FTST 1-67

FWAIT 1-68

FXAM 1-68

FXCH 1-69

FXTRACT 1-70

FYL2X 1-70

FYL2XP1 1-71

F2XM1 1-71

G

game control adapter, 1-211

 block diagram 1-211

 connector specifications 1-216

- functional description 1-212
- I/O channel description 1-213
- interface description 1-214
- joy stick schematic diagram 1-215

glossary, H-1

graphics mode, 1-141

- high resolution 1-144
- low resolution 1-142
- medium resolution 1-142

H

- hardware interrupt listing 1-11
- home head (printer) 1-105
- horizontal tab (printer) 1-102

I

- I/O address map 1-10
- I/O bit map, 8255A 1-12
- I/O CH CK (I/O Channel Check), I/O channel 1-20
- I/O CH RDY (I/O Channel Ready), I/O channel 1-20
- I/O Channel Check (I/O CH CK), I/O channel 1-20
- I/O channel interface,
 - diskette drive adapter 1-176
 - fixed disk drive adapter 1-187
 - prototype card 1-217
- I/O Channel Ready (I/O CH RDY), I/O channel 1-20
- I/O channel, 1-17
 - I/O Channel Check (I/O CH CK) 1-20
 - I/O Read Command (IOR) 1-20
 - I/O Write Command (IOW) 1-21
 - Address Bits 0 to 19 (A0-A19) 1-20
 - Address Enable (AEN) 1-21
 - Address Latch Enable (ALE) 1-20
 - Data Bits 0 to 7 (D0-D7) 1-20
 - description 1-20
 - diagram 1-18
 - DMA Request 1 to 3 (DRQ1-DRQ3) 1-21
 - I/O Channel Ready (I/O CH RDY) 1-20
 - Interrupt Request 2 to 7 (IRQ2-IRQ7) 1-20
 - Memory Read Command (MEMR) 1-21

- Memory Write Command (MEMW) 1-21
- Oscillator (OSC) 1-19
- Reset Drive (RESET DRV) 1-20
- System Clock (CLK) 1-20
- Terminal Count (T/C) 1-22
- I/O Read Command (IOR), I/O channel 1-21
- I/O Write Command (IOW), I/O channel 1-21
- IBM 10MB Fixed Disk Drive 1-201
- IBM 5-1/4" Diskette Drive 1-183
- IBM 5-1/4" Diskette Drive Adapter 1-159
- IBM 80 CPS Graphics Printer 1-91
- IBM 80 CPS Matrix Printer 1-91
- IBM 80 CPS Printers 1-91
- IBM Asynchronous Communications Adapter 1-223
- IBM Binary Synchronous Communications Adapter 1-251
- IBM Color Display 1-157
- IBM Color/Graphics Monitor Adapter 1-131
- IBM Communicatons Adapter Cable 1-301
- IBM Fixed Disk Drive Adapter 1-187
- IBM Game Control Adapter 1-211
- IBM Memory Expansion Options 1-205
- IBM Monochrome Display and Printer Adapter 1-223
- IBM Monochrome Display 1-129
- IBM Personal Computer Math Coprocessor 1-33
- IBM Printer Adapter 1-117
- IBM Prototype Card 1-215
- IBM Synchronous Data Link Controller Adapter 1-271
- ignore paper end (printer) 1-104
- INS8250,
 - (see National Semiconductor INS8250)
- Intel 8088 microprocessor,
 - arithmetic B-7
 - conditional transfer operations B-14
 - control transfer B-11
 - data transfer B-5
 - hardware interrupt listing 1-8
 - instruction set index B-18
 - instruction set matrix B-16
 - logic B-9
 - memory segmentation model B-4
 - operand summary B-15
 - processor control B-15
 - register model B-2

- second instruction byte summary B-3
- segment override prefix B-4
- software interrupt listing 2-4
- string manipulation B-10
- use of segment override B-4
- Intel 8253-5 Programmable Interval Timer
 - (see synchronous data link control communications adapter)
- Intel 8255A Programmable Peripheral Interface
 - I/O bit map 1-12
- Intel 8255A-5 Programmable Peripheral Interface
 - (see synchronous data link control communications adapter)
- Intel 8273 SDLC Protocol Controller
 - (see synchronous data link control communications adapter)
 - block diagram 1-273
- interrupt enable register 1-243
- interrupt identification register 1-243
- interrupt listing,
 - 8088 hardware 1-11
 - 8088 software 2-4
- Interrupt Request 1 to 7 (IRQ2-IRQ7), I/O channel 1-20
- interrupts,
 - 8088 hardware 1-11
 - 8088 software 2-4
 - asynchronous communications adapter 1-223
 - BASIC reserved 2-7
 - DOS reserved 2-21
 - special 2-7
- IOR (I/O Read Command), I/O channel 1-20
- IOW (I/O Write Command), I/O channel 1-21
- IRQ2-IRQ7 (Interrupt Request 2 to 7), I/O channel 1-20

J

- joy stick,
 - positions 1-221
 - schematic diagram 1-215
- jumper module, asynchronous communications adapter 1-249

K

- keyboard extended codes,
 - alt 2-15
 - break 2-16
 - caps lock 2-16
 - ctrl 2-15
 - pause 2-17
 - print screen 2-17
 - scroll lock 2-16
 - shift 2-15
 - shift key priorities 2-16
 - shift states 2-15
 - system reset 2-16
- keyboard 1-73
 - BASIC screen editor special functions 2-20
 - character codes 2-11
 - commonly used functions 2-18
 - diagram 1-76
 - DOS special functions 2-20
 - encoding 2-11
 - extended functions 2-14
 - interface block diagram 1-75
 - interface connector specifications 1-78
 - scan codes 1-77
 - specifications E-1

L

- light pen connector specifications 1-156
- line control register 1-235
- line feed (printer) 1-102
- line status register 1-239
- logic diagrams D-1

M

- math coprocessor 1-33
 - block diagram 1-37
 - control unit 1-37
 - control word 1-40

data types 1-34
exception pointers 1-41
FABS 1-44
FADD 1-44
FBLD 1-45
FBSTP 1-46
FCHS 1-46
FCLEX/FNCLEX 1-46
FCOM 1-47
FCOMP 1-47
FCOMPP 1-48
FDECSTP 1-48
FDISI/FNDISI 1-48
FDIV 1-49
FDIVR 1-50
FENI/FNENI 1-51
FFREE 1-51
FICOM 1-51
FICOMP 1-52
FILD 1-52
FINCSTP 1-52
FINIT/FNINIT 1-53
FIST 1-54
FISTP 1-54
FLD 1-55
FLDCW 1-55
FLDENV 1-56
FLDLG2 1-56
FLDLN2 1-56
FLDL2E 1-57
FLDL2T 1-57
FLDPI 1-57
FLDZ 1-58
FLD1 1-58
FMUL 1-59
FNOP 1-60
FPATAN 1-60
FPREM 1-60
FPTAN 1-61
FRNDINT 1-61
FRSTOR 1-61

- FSAVE/FNSAVE 1-62
- FSCALE 1-62
- FSQRT 1-62
- FST 1-63
- FSTCW/FNSTCW 1-63
- FSTENV/FNSTENV 1-64
- FSTP 1-64
- FSTSW/FNSTSW 1-65
- FSUB 1-65
- FSUBR 1-66
- FTST 1-67
- FWAIT 1-68
- FXAM 1-68
- FXCH 1-69
- FXTRACT 1-70
- FYL2X 1-70
- FYL2XP1 1-71
- F2XM1 1-71
- hardware interface 1-35
- instruction set 1-43
- interconnection 1-36
- number system 1-42
- programming interface 1-34
- register stack 1-38
- status word 1-39
- tag word 1-41
- memory expansion options, 1-205
 - DIP module start address 1-208
 - memory module description 1-206
 - memory module pin configuration 1-207
 - memory option switch settings G-1
 - R/W memory operating characteristics 1-206
 - switch-configurable start address 1-208
- memory locations,
 - reserved 2-8
- memory map,
 - BIOS 2-9
 - system 1-13
- Memory Read Command (MEMR), I/O channel 1-21
- memory switch settings, G-1
 - extender card G-1
 - memory options G-1
 - system board G-1

- Memory Write Command (MEMW), I/O channel 1-21
- (MEMR) Memory Read Command, I/O channel 1-21
- (MEMW) Memory Write Command, I/O channel 1-21
- microprocessor (see Intel 8088 microprocessor)
- mode control and status register 1-149
- mode select register 1-151
- modem control register 1-244
- modem status register 1-246
- monochrome display 1-129
- monochrome display and printer adapter 1-123
- monochrome display adapter 1-123
 - 6845 CRT control port 1-127
 - 6845 CRT status port 1-127
 - block diagram 1-124
 - character attributes 1-138
 - connector specifications 1-128
 - I/O address and bit map 1-127
 - programming considerations 1-125
- monochrome display, 1-129
 - operating characteristics 1-129
 - specifications E-3
- Motorola 6845 CRT Controller,
 - (see color/graphics monitor adapter)
 - (see monochrome display adapter)

N

- National Semiconductor INS8250 Asynchronous
 - (see asynchronous communications adapter)
 - functional pin description 1-229
 - input signals 1-229
 - input/output signals 1-233
 - output signals 1-232
- null (printer) 1-102

O

- one bit delay mode register 1-289
- operating mode register 1-289
- OSC (oscillator) 1-19
- Oscillator (OSC), I/O channel 1-19
- over-voltage/over-current (expansion unit) 1-84
- over-voltage/over-current (system unit) 1-27

P

- parameter passing (ROM BIOS) 2-3
- pause (keyboard extended code) 2-17
- power good signal (expansion unit) 1-84
- power good signal (system unit) 1-27
- power supply (expansion unit) 1-82
 - connectors 1-83
 - input requirements 1-82
 - over-voltage/current protection 1-84
 - pin assignments 1-83
 - power good signal 1-83
 - Vac output 1-82
 - Vdc output 1-82
- power supply (system unit) 1-23
 - connectors and pin assignments 1-26
 - input requirements 1-24
 - over-voltage/current protection 1-27
 - pin assignments 1-26
 - power good signal 1-27
 - Vac output 1-25
 - Vdc output 1-25
- print screen (keyboard extended code) 2-17
- printer adapter, 1-117
 - block diagram 1-118
 - connector specifications 1-122
 - programming considerations 1-119
- printer control codes, 1-101
 - 1/8-inch line feeding 1-104
 - 1920 bit-image graphics mode 1-110
 - 480 bit-image graphics mode 1-107
 - 7/72-inch line feeding 1-104
 - 960 bit-image graphics mode 1-109
 - 960 bit-image graphics mode normal speed 1-110
- bell 1-102
- cancel 1-103
- cancel ignore paper end 1-105
- cancel skip perforation 1-109
- carriage return 1-102
- clear printer buffer 1-110
- compressed 1-103
- compressed off 1-103
- double strike 1-106
- double strike off 1-107
- double width 1-103, 1-110

- double width off 1-103
- emphasized 1-106
- emphasized off 1-106
- escape 1-103
- form feed 1-102
- home head 1-105
- horizontal tab 1-102
- ignore paper end 1-104
- line feed 1-102
- null 1-102
- printer deselected 1-103
- printer selected 1-103
- select character set 1 1-104
- select character set 2 1-104
- set horizontal tab stops 1-106
- set lines per page 1-106
- set skip perforation 1-109
- set variable line feeding 1-105, 1-107
- set vertical tabs 1-105
- starts variable line feeding 1-105
- subscript/superscript 1-109
- subscript/superscript off 1-109
- underline 1-104
- unidirectional printing 1-109
- vertical tab 1-102
- printer deselected (printer) 1-103
- printer selected (printer) 1-103
- printer, 1-91
 - additional specifications 1-93
 - cable 1-91
 - connector pin assignment 1-97
 - control codes 1-101
 - graphic character set 1 1-113
 - graphic character set 2 1-115
 - interface signal descriptions 1-96
 - matrix character set 1-111
 - modes 1-100
 - parallel interface 1-96
 - parallel interface timing diagram 1-96
 - specifications 1-92, E-3
 - switch locations 1-94
 - switch settings 1-94
- processor (see Intel 8088 microprocessor)
- programmable baud rate generator 1-237

- programming considerations,
 - asynchronous communications adapter 1-234
 - binary synchronous communications adapter 1-259
 - color/graphics monitor adapter 1-131
 - diskette drive adapter 1-159
 - extender card 1-86
 - fixed disk drive adapter 1-187
 - monochrome display adapter 1-123
 - printer adapter 1-123
 - receiver card 1-88
 - SDLC adapter 1-281
- prototype card, 1-217
 - block diagram 1-218
 - external interface 1-222
 - I/O channel interface 1-219
 - layout 1-219
 - system loading and power limitations 1-221

Q

quick reference, character set C-12

R

- receiver buffer register 1-247
- receiver card, 1-88
 - block diagram 1-89
 - programming considerations 1-86
- register,
 - 6845 description (color/graphic adapter) 1-146
 - color select (color/graphic adapter) 1-147
 - command status 0 (diskette drive adapter) 1-172
 - command status 1 (diskette drive adapter) 1-173
 - command status 2 (diskette drive adapter) 1-174
 - command status 3 (diskette drive adapter) 1-175
 - data (fixed disk drive adapter) 1-192
 - data transfer mode (SDLC) 1-288
 - digital output (diskette drive adapter) 1-161
 - DPC (diskette drive adapter) 1-175
 - interrupt enable (asynchronous communications) 1-243
 - interrupt identification (asynchronous communications) 1-241
 - line control (asynchronous communications) 1-234
 - line status (asynchronous communications) 1-239
 - mode control and status (color/graphics) 1-149

- mode select (color/graphics) 1-151
- modem control (asynchronous communications) 1-244
- modem status (asynchronous communications) 1-246
- one-bit delay mode (SDLC) 1-289
- operating mode (SDLC) 1-286
- receiver buffer (asynchronous communications) 1-247
- serial I/O mode (SDLC) 1-288
- status (color/graphics) 1-153
- status (fixed disk drive adapter) 1-187
- transmitter holding (asynchronous communications) 1-248
- reserved interrupts,
 - BASIC and DOS 2-7
- reserved memory locations 2-7
- Reset Drive (RESET DRV), I/O channel 1-19
- RESET DRV (Reset Drive), I/O channel 1-19
- RF modulator connector specifications 1-156
- ROM BIOS, 2-2
 - Cassette A-74
 - Fixed Disk A-87
 - System A-2
- ROM, adapter cards with 2-10
- RS-232C,
 - interface standards F-2

S

- scan codes,
 - keyboard 1-77
- scroll lock (keyboard extended code) 2-16
- SDLC (see synchronous data link control)
- select character set 1 (printer) 1-104
- select character set 2 (printer) 1-104
- sense bytes, fixed disk drive adapter 1-189
- serial I/O mode register 1-288
- set horizontal tab stops (printer) 1-106
- set lines per page (printer) 1-106
- set skip perforation (printer) 1-109
- set variable line feeding (printer) 1-105, 1-107
- set vertical tabs (printer) 1-105
- shift (keyboard extended code) 2-15
- shift key priorities (keyboard code) 2-16
- shift states (keyboard extended code) 2-15
- software interrupt listing 2-4
- speaker connector 1-23
- speaker drive system 1-23
- speaker interface 1-23

- specifications,
 - 80 CPS printers E-3
 - color display E-2
 - expansion unit E-2
 - keyboard E-1
 - monochrome display E-3
 - printer 1-92
 - printer (additional) 1-93
 - system unit E-1
- stack area 2-7
- starts variable line feeding (printer) 1-104
- status register,
 - color/graphics monitor adapter 1-154
 - fixed disk drive adapter 1-189
 - synchronous data link control adapter 1-282
- subscript/superscript (printer) 1-109
- subscript/superscript off (printer) 1-109
- switch settings, G-1
 - diskette drive G-1
 - display adapter type G-1
 - extender card G-1
 - memory options G-1
 - printer 1-91
 - system board G-1
 - system board memory G-1
- synchronous data link control communications adapter, 1-271
 - 8253-5 interval timer control word 1-285
 - 8253-5 programmable interval timer 1-281
 - 8255A-5 port A assignments 1-280
 - 8255A-5 port B assignments 1-280
 - 8255A-5 port C assignments 1-281
 - 8255A-5 programmable peripheral interface 1-280
 - 8273 command phase flow chart 1-292
 - 8273 commands 1-291
 - 8273 control/read/write registers 1-275
 - 8273 data interfaces 1-276
 - 8273 elements of data transfer interface 1-276
 - 8273 mode register commands 1-288
 - 8273 modem control block 1-277
 - 8273 modem control port A 1-277
 - 8273 modem control port B 1-278
 - 8273 modem interface 1-277
 - 8273 protocol controller operations 1-271
 - 8273 protocol controller structure 1-273
 - 8273 register selection 1-274
 - 8273 SDLC protocol controller block diagram 1-273

- 8273 transmit/receiver timing 1-279
- block diagram 1-271
- command phase 1-290
- connector specifications 1-299
- control/read/write logic 1-274
- data transfer mode register 1-288
- device addresses 1-297
- execution phase 1-293
- general receive 1-294
- initialization/configuration commands 1-286
- initializing the SDLC adapter 1-283
- interface information 1-298
- interrupt information 1-297
- one bit delay code register 1-289
- operating mode register 1-286
- partial byte received codes 1-296
- processor interface 1-274
- programming considerations 1-281
- protocol control module features 1-272
- protocol controller operations 1-272
- result code summary 1-296
- result phase 1-291
- selective receive 1-295
- serial data timing block 1-279
- serial I/O mode register 1-288
- status register format 1-282
- transmit 1-294
- system block diagram 1-2
- system board, 1-3
 - component diagram 1-7
 - data flow 1-8
 - R/W memory operating characteristics 1-202
 - switch settings G-1
- System Clock (CLK), I/O channel 1-19
- system memory map 1-13
- system reset (keyboard extended code) 2-16
- system ROM BIOS A-2
- system unit, 1-3
 - cassette interface 1-31
 - I/O channel 1-17
 - I/O channel diagram 1-18
 - keyboard interface 1-78
 - power supply 1-23
 - speaker interface 1-22
 - specifications E-1
 - system board 1-3

T

T/C (Terminal Count), I/O channel 1-22
transmitter holding register 1-248

U

underline (printer) 1-104
unidirectional printer (printer) 1-109

V

Vac output,
 expansion unit 1-82
 system unit 1-25
Vdc output,
 expansion unit 1-82
 system unit 1-25
vectors with special meanings 2-5
vertical tab (printer) 1-102
voltage interchange,
 asynchronous communications adapter 1-228

Numerics

1/8 inch line feeding (printer) 1-104
1920 bit-image graphics mode (printer) 1-110
480 bit-image graphics mode (printer) 1-107
6845,
 (see color/graphics monitor adapter)
 (see monochrome display adapter)
7/72 inch line feeding (printer) 1-104
8088,
 (see Intel 8088 microprocessor)
8250,
 (see asynchronous communications adapter)
8253-5,
 (see synchronous data link control adapter)
8255A 1-12
8255A-5,
 (see synchronous data link control adapter)
8273,
 (see synchronous data link control adapter)
960 bit-image graphics mode (printer) 1-109
960 bit-image graphics mode normal speed (printer) 1-110



Product Comment Form

TECHNICAL REFERENCE

1502234

Your comments assist us in improving our products. IBM may use and distribute any of the information you supply in anyway it believes appropriate without incurring any obligation whatever. You may, of course, continue to use the information you supply.

For prompt resolution to questions regarding set up, operation, program support, and new program literature, contact the Authorized IBM Personal Computer Dealer in your area.

Comments:

If you wish a reply, provide your name and address in this space.

Name _____

Address _____

City _____ State _____

Zip Code _____

Tape

Please do not staple

Tape

Fold here

BOCA RATON, FLORIDA 33432
P.O. BOX 1328-C
SALES & SERVICE
IBM PERSONAL COMPUTER

POSTAGE WILL BE PAID BY ADDRESSEE

FIRST CLASS PERMIT NO. 123 BOCA RATON, FLORIDA 33432

BUSINESS REPLY MAIL

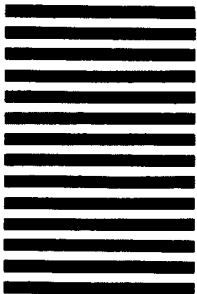

NO POSTAGE
NECESSARY
IF MAILED
IN THE
UNITED STATES



Product Comment Form

TECHNICAL REFERENCE

1502234

Your comments assist us in improving our products. IBM may use and distribute any of the information you supply in anyway it believes appropriate without incurring any obligation whatever. You may, of course, continue to use the information you supply.

For prompt resolution to questions regarding set up, operation, program support, and new program literature, contact the Authorized IBM Personal Computer Dealer in your area.

Comments:

If you wish a reply, provide your name and address in this space.

Name _____

Address _____

City _____ State _____

Zip Code _____

Tape

Please do not staple

Tape

Fold here

BOCA RATON, FLORIDA 33432
P.O. BOX 1328-C
SALES & SERVICE
IBM PERSONAL COMPUTER

POSTAGE WILL BE PAID BY ADDRESSEE

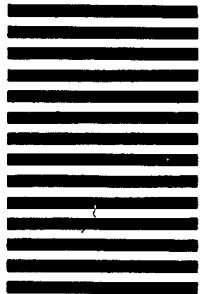

BUSINESS REPLY MAIL
FIRST CLASS PERMIT NO. 123 BOCA RATON, FLORIDA 33432

NO POSTAGE
NECESSARY
IF MAILED
IN THE
UNITED STATES





Product Comment Form

TECHNICAL REFERENCE

1502234

Your comments assist us in improving our products. IBM may use and distribute any of the information you supply in anyway it believes appropriate without incurring any obligation whatever. You may, of course, continue to use the information you supply.

For prompt resolution to questions regarding set up, operation, program support, and new program literature, contact the Authorized IBM Personal Computer Dealer in your area.

Comments:

If you wish a reply, provide your name and address in this space.

Name _____

Address _____

City _____ State _____

Zip Code _____

Tape

Please do not staple

Tape

Fold here

IBM PERSONAL COMPUTER
SALES & SERVICE
P.O. BOX 1328-C
BOCA RATON, FLORIDA 33432

POSTAGE WILL BE PAID BY ADDRESSEE

FIRST CLASS PERMIT NO. 123 BOCA RATON, FLORIDA 33432

BUSINESS REPLY MAIL

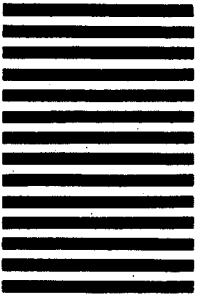
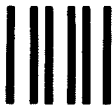

NO POSTAGE
NECESSARY
IF MAILED
IN THE
UNITED STATES