



AUTO-SCANNING WITH DIGITAL CONTROL
COLOR DISPLAY MONITOR

Diamond Plus 73

USER'S GUIDE



For future reference, record the serial number of your display monitor in the space below:

SERIAL No.

The serial number is located on the rear cover of the monitor.

Internet Home Page: <http://www.mitsubishi-electric.com.au/>

Supplying Windows® 95/98/2000 INF File download service, new product information, etc.

RADIO INTERFERENCE REGULATIONS STATEMENT FOR U.S.A.

This equipment has been tested and found to comply with the limits for a Class B digital device, pursuant to Part 15 of the FCC Rules. These limits are designed to provide reasonable protection against harmful interference in a residential installation. This equipment generates, uses and can radiate radio frequency energy and, if not installed and used in accordance with the instructions, may cause harmful interference to radio communications. However, there is no guarantee that interference will not occur in a particular installation. If this equipment does cause harmful interference to radio or television reception, which can be determined by turning the equipment off and on, the user is encouraged to try to correct the interference by one or more of the following measures:

- Reorient or relocate the receiving antenna.
- Increase the separation between the equipment and receiver.
- Connect the equipment into an outlet on a circuit different from that to which the receiver is connected.
- Consult the dealer or an experienced radio/TV technician for help.

THIS PRODUCT HAS BEEN TESTED AND FOUND TO COMPLY WITH THE LIMITS. USE IT TO REDUCE THE POSSIBILITY OF CAUSING INTERFERENCE TO RADIO, TELEVISION, AND OTHER ELECTRIC DEVICES.
NO USER SERVICEABLE PARTS INSIDE. DO NOT ATTEMPT TO MODIFY THIS EQUIPMENT. IF MODIFIED, YOUR AUTHORITY TO OPERATE THIS EQUIPMENT MIGHT BE VOIDED BY FCC.



Congratulations!

You have just purchased a TCO'99 approved and labelled product! Your choice has provided you with a product developed for professional use. Your purchase has also contributed to reducing the burden on the environment and also to the further development of environmentally adapted electronics products.

Why do we have environmentally labelled computers?

In many countries, environmental labelling has become an established method for encouraging the adaptation of goods and services to the environment. The main problem, as far as computers and other electronics equipment are concerned, is that environmentally harmful substances are used both in the products and during their manufacture. Since it is not so far possible to satisfactorily recycle the majority of electronics equipment, most of these potentially damaging substances sooner or later enter nature.

There are also other characteristics of a computer, such as energy consumption levels, that are important from the viewpoints of both the work (internal) and natural (external) environments. Since all methods of electricity generation have a negative effect on the environment (e.g. acidic and climate-influencing emissions, radioactive waste), it is vital to save energy. Electronics equipment in offices is often left running continuously and thereby consumes a lot of energy.

What does labelling involve?

This product meets the requirements for the TCO'99 scheme which provides for international and environmental labelling of personal computers. The labelling scheme was developed as a joint effort by the TCO (The Swedish Confederation of Professional Employees), Svenska Naturskyddsforeningen (The Swedish Society for Nature Conservation) and Statens Energimyndighet (The Swedish National Energy Administration).

Approval requirements cover a wide range of issues: environment, ergonomics, usability, emission of electric and magnetic fields, energy consumption and electrical and fire safety.

The environmental demands impose restrictions on the presence and use of heavy metals, brominated and chlorinated flame retardants, CFCs (freons) and chlorinated solvents, among other things. The product must be prepared for recycling and the manufacturer is obliged to have an environmental policy which must be adhered to in each country where the company implements its operational policy.

The energy requirements include a demand that the computer and/or display, after a certain period of inactivity, shall reduce its power consumption to a lower level in one or more stages. The length of time to reactivate the computer shall be reasonable for the user.

Labelled products must meet strict environmental demands, for example, in respect of the reduction of electric and magnetic fields, physical and visual ergonomics and good usability.

Below you will find a brief summary of the environmental requirements met by this product. The complete environmental criteria document may be ordered from:

TCO Development

SE-114 94 Stockholm, Sweden

Fax: +46 8 782 92 07

Email (Internet): development@tco.se

Current information regarding TCO'99 approved and labelled products may also be

obtained via the Internet, using the address:

<http://www.tco-info.com/>

Environmental requirements

Flame retardants

Flame retardants are present in printed circuit boards, cables, wires, casings and housings. Their purpose is to prevent, or at least to delay the spread of fire. Up to 30% of the plastic in a computer casing can consist of flame retardant substances. Most flame retardants contain bromine or chloride, and those flame retardants are chemically related to another group of environmental toxins, PCBs. Both the flame retardants containing bromine or chloride and the PCBs are suspected of giving rise to severe health effects, including reproductive damage in fish-eating birds and mammals, due to the bio-accumulative* processes. Flame retardants have been found in human blood and researchers fear that disturbances in foetus development may occur.

The relevant TCO'99 demand requires that plastic components weighing more than 25 grams must not contain flame retardants with organically bound bromine or chlorine. Flame retardants are allowed in the printed circuit boards since no substitutes are available.

Cadmium**

Cadmium is present in rechargeable batteries and in the colour-generating layers of certain computer displays. Cadmium damages the nervous system and is toxic in high doses. The relevant TCO'99 requirement states that batteries, the colour-generating layers of display screens and the electrical or electronics components must not contain any cadmium.

Mercury**

Mercury is sometimes found in batteries, relays and switches. It damages the nervous system and is toxic in high doses. The relevant TCO'99 requirement states that batteries may not contain any mercury. It also demands that mercury is not present in any of the electrical or electronics components associated with the labelled unit.

CFCs (freons)

The relevant TCO'99 requirement states that neither CFCs nor HCFCs may be used during the manufacture and assembly of the product. CFCs (freons) are sometimes used for washing printed circuit boards. CFCs break down ozone and thereby damage the ozone layer in the stratosphere, causing increased reception on earth of ultraviolet light with e.g. increased risks of skin cancer (malignant melanoma) as a consequence.

Lead**

Lead can be found in picture tubes, display screens, solders and capacitors. Lead damages the nervous system and in higher doses, causes lead poisoning. The relevant TCO'99 requirement permits the inclusion of lead since no replacement has yet been developed.

* Bio-accumulative is defined as substances which accumulate within living organisms

** Lead, Cadmium and Mercury are heavy metals which are Bio-accumulative.

CONTENTS

CAUTION

The power cord provided with this monitor is designed for safety and must be used with a properly grounded outlet to avoid possible electrical shock.

Do not remove the monitor cabinet as this can expose you to very high voltages and other hazards.

WARNING!

This product is not designed for use in life support devices and Mitsubishi Electric Australia Pty. Ltd. makes no representations to the contrary. Life support devices are those devices which are used to measure, diagnose, or evaluate the tissue, systems or functions of the human body; or other devices employed to support or sustain life or good health.

Trademark

IBM, PC, PS/2, PS/V, Personal System/2 are registered trademarks of International Business Machines Corp.

Apple Macintosh is a registered trademark of Apple Computer, Inc. Quadra is a trademark of Apple Computer, Inc.

UNIX is a registered trademark in the United States and other countries, licensed exclusively through X/Open Company Limited.

ENERGY STAR is a U.S. registered mark.

1. INTRODUCTION	2
1.1 Features	2
1.2 Internal Preset Memory Capability	3
1.3 Power Management Function	3
1.4 DDC	3
1.5 Location Considerations	3
1.6 Cleaning Your Monitor	3
1.7 Unpacking	4
1.8 Tilt/Swivel Base	4
Screen Position Adjustment	4
1.9 Quick Operation Chart	4
2. PART NAME	5
2.1 Control Names	5
2.2 Function	5
3. INSTALLATION AND CONNECTION	6
3.1 AC Power Connection	6
3.2 Signal Cable Connection	6
3.2.1 Connecting to any IBM VGA Compatible System	6
3.2.2 Connecting to an Apple Macintosh Computer	6
4. OSD(On Screen Display) FUNCTIONS	7
4.1 How to adjust the screen	7
4.2 Adjustment Items	8
5. TROUBLESHOOTING	9
6. SPECIFICATIONS	11
7. WARRANTY	12

1 INTRODUCTION

Congratulations on your purchase of this high resolution color monitor. We designed this monitor to provide you with years of reliable trouble-free operation.

This guide tells you how to connect, adjust and care for your monitor. This guide also provides technical specifications and instructions for troubleshooting any basic problems you may experience with your monitor.

1.1 Features

This monitor is a 43cm/17" (41cm/16" Viewable Image Size) intelligent, microprocessor-based monitor compatible with most analog RGB (Red, Green, Blue) display standards.

It provides crisp text and vivid color graphics with both PC and Macintosh platforms.

- The monitor's wide auto-scanning compatibility range makes it possible to upgrade video cards or software without purchasing a new monitor.
 - Digitally controlled auto-scanning is done using an internal microprocessor, for horizontal scan frequencies between 31kHz and 70kHz, and vertical scan frequencies between 55Hz and 120Hz. The microprocessor-based intelligence allows the monitor to operate in each frequency mode with the precision of a fixed frequency monitor.
 - The monitor contains resident memory for pre-programmed screen display standards and is also capable of storing additional user adjustment parameters.
 - The monitor is capable of producing a non-interlaced maximum addressable resolution format of 1280 dots x 1024 lines. This display is well suited for windowing environments.
 - Because of the analog signal inputs, the monitor can display an unlimited palette of colors that can be manually adjusted to suit your specific needs.
 - The monitor has a power management function accorded to VESA-DPMS-standard. To save energy, the monitor must be connected to a system compliant with the VESA-DPMS standard. (Refer to your computer and/or video card instructions for proper operation.)
 - To ensure ease of installation and ongoing use, the monitor features On Screen Display (OSD) of all monitor set-up and adjustment functions.
 - For use in a variety of applications, the monitor complies with UL 1950, CSA C22.2 No.950 and EN60950 for safety, FCC Class-B, EN55022 Class-B and AS/NZS 3548 Class-B for EMI, MPR-II, ISO 9241-3, ISO9241-7 and ISO9241-8 for ergonomics. The monitor also complies with TCO'99 guideline for environmental safe use.
 - This monitor features the new standard in CRT technology, the DIAMONDTRON NF with improved focus and convergence for super-sharp and pure displayed images.
- The monitor complies with Video Electronics Standards Association (VESA) DDC1/2B(EDID) specification. If your computer is Plug & Play compliant setup will be done automatically.
 - The CRT provides fine 0.25mm variable aperture grille pitch/Maximum addressable resolution of 1280x1024.

1.2 Internal Preset Memory Capability

To minimize adjustment needs, the factory has preset popular display standards into the monitor, as shown in Table 1. If any of these display standards are detected, the picture size and position are automatically adjusted. All of the factory presets may be overwritten by adjusting the user controls. This monitor is capable of automatically storing up to 24 additional display standards. The new display information must differ from any of the existing display standards by at least 1kHz for the horizontal scan frequency or 4Hz for the vertical scan frequency or the sync signal polarities must be different.

Table 1. Memory Buffer Factory Presets

PRESET TIMING	Fh(kHz)	Fv(Hz)	Polarity	
			H	V
640 x 400 N.I.	31.5	70.1	-	+
640 x 480 N.I.	31.5	59.9	-	-
640 x 480 N.I.	37.5	75.0	-	-
640 x 480 N.I.	43.3	85.0	-	-
800 x 600 N.I.	37.9	60.3	+	+
800 x 600 N.I.	46.9	75.0	+	+
800 x 600 N.I.	53.7	85.0	+	+
1024 x 768 N.I.	48.4	60.0	-	-
1024 x 768 N.I.	56.5	70.1	-	-
1024 x 768 N.I.	60.0	75.0	+	+
1024 x 768 N.I.	68.7	85.0	+	+
1280 x 1024 N.I.	64.0	60.0	+	+

1.3 Power Management Function

The monitor has a power management function which reduces the power consumption of the monitor when not in use.

The power saving mode is invoked by a VESA DPMS-compliant computer. Check your computer's manual for setting this function.

Mode	Power	Power-On Indicator
Normal	73 W	Green
Power Saving Mode	≤ 5 W	Orange

1.4 DDC

The monitor includes the VESA DDC1 and DDC2B feature. DDC (Display Data Channel) is a communication channel over which the monitor automatically informs the computer system about its capabilities (e.g. each supported resolution with its corresponding timing).

DDC is routed through previously unused pins of the 15-pin VGA connector.

The system will "Plug and Play" if both monitor and computer implement the DDC protocol.

1.5 Location Considerations

When setting up and using the monitor, keep the following in mind:

- For optimum viewing, avoid placing the monitor against a bright background or where sunlight or other light sources may reflect on the display area of the monitor. Place the monitor just below eye level.
- Place the monitor away from strong magnetic or electromagnetic fields, such as high capacity transformers, electric motors, large current power lines, steel pillars, etc....
Magnetism can cause distortion in the picture and/or colour purity.
- Avoid covering the slots or openings of the monitor. Allow adequate ventilation around the monitor so the heat from the monitor can properly dissipate. Avoid putting the monitor into any enclosure that does not have adequate ventilation.
- Avoid exposing the monitor to rain, excessive moisture, or dust, as this can cause a fire or shock hazard.
- Avoid placing the monitor, or any other heavy object, on the power cord. Damage to the power cord can cause a fire or electrical shock.
- When transporting the monitor, handle it with care.

1.6 Cleaning Your Monitor

When cleaning the monitor, please follow these guidelines:

- Always unplug the monitor before cleaning.
- Wipe the screen and the front and sides of the cabinet with a soft, dry cloth.
- If the screen requires more than dusting, apply a household window cleaner to a soft cloth to clean the monitor screen.

CAUTION

- Do not use benzene, thinner or any volatile substances to clean the unit as the finish may be permanently marked.
- Never leave the monitor in contact with rubber or vinyl for an extended time period.
- Do not spray directly on the screen as cleaner may drip into the monitor and damage the circuitry.
- Never use an abrasive cleaner on the screen surface as this will damage the anti-reflection coating.

2 PART NAME

2.1 Control Names

See Figures 3 and 4 for the location of the user controls, indicator and connectors.

Each part is identified by number and is described individually.

FRONT

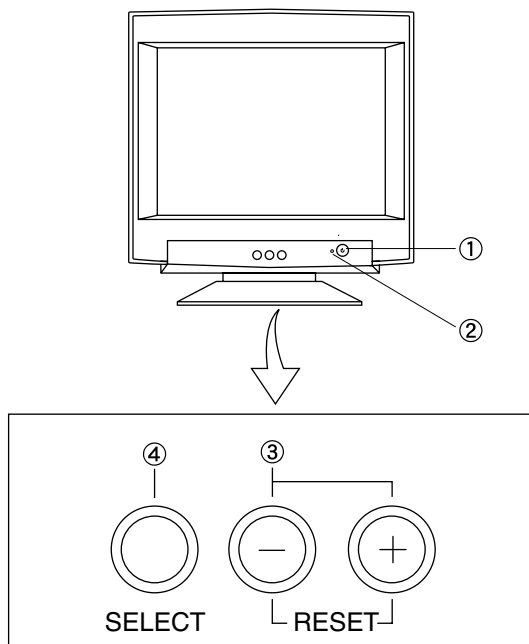

Figure 3

REAR

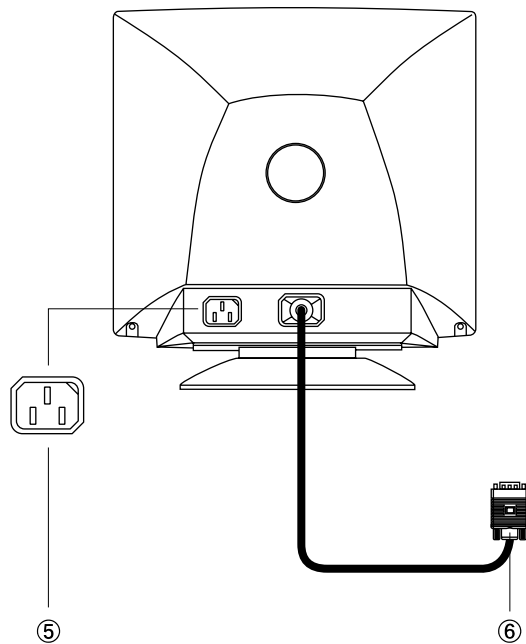

Figure 4

2.2 Function

- 1. POWER SWITCH:** A push-on / push-off switch for AC power.
- 2. POWER-ON INDICATOR:** This indicator illuminates green when AC power is on, and illuminates orange when the monitor is in the power management modes.
- 3. - / + BUTTON:**
 - With item select screen, push to select the item icon.
 - With item adjustment screen, push to adjust the image on the screen.
 - Without OSD screen, push to adjust the contrast.
- 4. SELECT BUTTONS:**
 - Push to turn on the OSD screen.
 - With item select screen, push to proceed the adjustment screen.

- 5. AC POWER CONNECTOR**

- 6. SIGNAL INPUT CONNECTOR: DB9-15P**

3 INSTALLATION AND CONNECTION

On the back of the monitor two kinds of plug-in connections are provided: AC power connector for the AC input, DB9-15P connector for video signal input.

3.1 AC Power Connection

One end of the AC power cord is connected to the AC power connector on the back of the monitor. The other end is plugged into a properly grounded three-prong AC outlet. The monitor's auto-sensing power supply can automatically detect 100-240V AC and 50 or 60Hz.

3.2 Signal Cable Connection

The DB9-15P(VGA) connector is provided for compatible analog RGB outputs from your computer. Apple Macintosh computers can also be interfaced with using the optional Macintosh adapter.

3.2.1 Connecting to Any IBM VGA Compatible System

Figure 5 shows the signal cable connection to the Video Graphics Array (VGA) port in an IBM Personal System/2 series, or any VGA compatible system.

1. Power off, both the monitor and the computer.
2. Connect the one end of the signal cable to the DB9-15P connector on the VGA controller card.
3. Power on the monitor, then the computer.
4. After using the system, power off the monitor, then the computer.

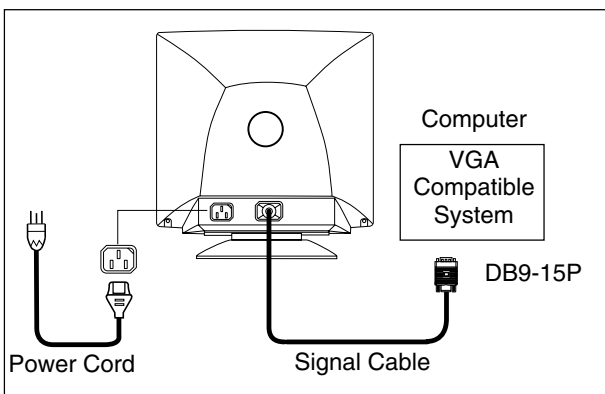

Figure 5

CAUTION

The socket-outlet shall be installed near the equipment and shall be easily accessible. During servicing, disconnect the plug from the socket-outlet.

3.2.2 Connecting to An Apple Macintosh Computer

Figure 6 shows the signal cable and Adapter (option) to the video port in an Apple Macintosh.

The Macintosh Adapter is available that converts the 2 row D-sub video connector on legacy Macintosh computers to a 3 row D-sub(VGA) connector compatible with your Mitsubishi monitor. The Macintosh Adapter is not needed on G3 (ice and blue) and later version of the Macintosh. Macintosh Adapters are available from Mitsubishi Electric Australia. Should your system require an Adapter, please contact your computer dealer.

1. Power off, both the monitor and the computer.
2. Set the DIP switches of Macintosh Adapter according to the setting chart.
3. Connect the 15-pin (DB-15P) end of the Adapter to the straight 15-pin connector on the Macintosh video port on the computer or on the video board.
4. Connect the sub-miniature 15-pin (DB9-15P) end of the Adapter to the signal cable.
5. Power on the monitor, then the Macintosh.
6. After using the system, power off the monitor, then the Macintosh.

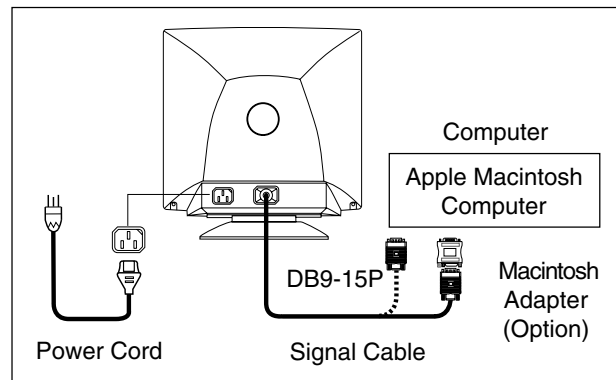

Figure 6

NOTE

- For the Apple Macintosh Computers having a VGA compatible port, steps 2 through 4 are not necessary. Connect the end of the signal cable to the port directly.
- If you have an Apple Macintosh G3 series, use the Control Panel in the Apple Menu to select a resolution. If the resolution is selected from the Control Strip, the screen may go blank and the computer may freeze.

4 OSD (On Screen Display) FUNCTIONS

4.1 How to adjust the screen

The monitor has an OSD(On Screen Display) function.

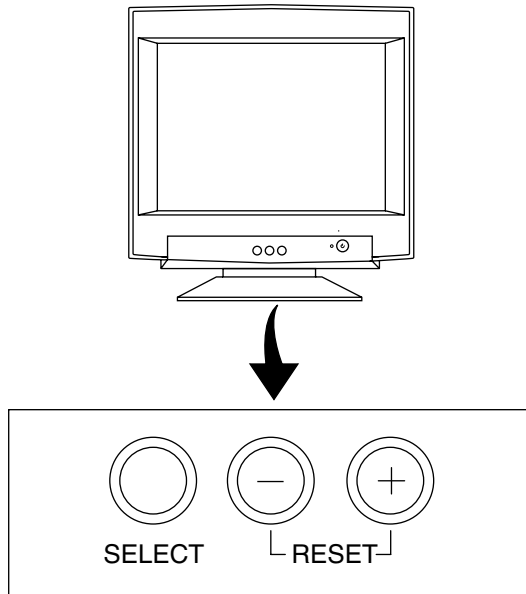

The following procedure shows how to adjust the screen using the OSD function.



(1) Turn on the monitor by pressing 



(2) Display the OSD screen by pressing  SELECT

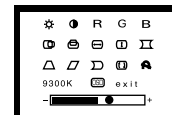

(3) Select the item icon on item select screen by pressing  

(4) Display the item adjustment screen by pressing  SELECT





















(5) Adjust by pressing  

(6) To turn the OSD screen off, select "exit" and press button  SELECT



If you don't press a button during 10 seconds, the OSD will turn off automatically.

4.2 Adjustment Items

X: Available

Item Icon	Item	Press the Minus Button 	Press the Plus Button 	A	B
	Brightness	To decrease the brightness.	To increase the brightness.	X	X
	Contrast	To decrease the contrast. NOTE Without OSD screen, push to adjust the contrast.	To increase the contrast.	X	X
	Red Color Control	To decrease the red contrast.	To increase the red contrast.	X	X
	Green Color Control	To decrease the green contrast.	To increase the green contrast.	X	X
	Blue Color Control	To decrease the blue contrast.	To increase the blue contrast.	X	X
	Horizontal position	To move the image on the screen to the left.	To move the image on the screen to the right.	X	
	Vertical position	To move the image down.	To move the image up.	X	
	Horizontal size	To narrow the width of the image on the screen.	To expand the width of the image on the screen.	X	
	Vertical size	To narrow the height of the image on the screen.	To expand the height of the image on the screen.	X	
	Pincushion / Barrel	To contract the center of the image.	To expand the center of the image.	X	
	Trapezoid	To decrease the width at the top of the screen image and to increase the width at the bottom.	To increase the width at the top of the screen image and to decrease the width at the bottom.	X	
	Parallelogram	To make the screen slant to the left.	To make the screen slant to the right.	X	X
	Bow (Pincushion Balance)	To move the top and bottom of the screen image to the right.	To move the top and bottom of the screen image to the left.	X	X
	Rotates	To rotate the image counterclockwise.	To rotate the image clockwise.	X	X
	Degauss	Select the degauss icon on "Item select screen" and push "SELECT" button. It will eliminate the stray magnetic field and correct the scan of the electron beam, which affect the purity, focus and convergence. NOTE Allow a minimum interval of 20 minutes to elapse between uses of the degauss function.		-	-
9300K	Color Temperature	Select the Color Temperature icon on "Item select screen" and push "SELECT" button.		-	X
	OSD	There are 3 background colors (Blue, Black, and White). These can be selected by "SELECT" button after the selection of "OSD" on "Item select screen"		-	X
e x i t	EXIT	To exit OSD screen. Select EXIT on "Item select screen", then push "SELECT" button.		-	-

NOTE

- A. Press  and  button together, to restore to the factory preset.
B. Set data does not change by the change of the signal timing.

5 TROUBLESHOOTING

Before calling your Authorized Product Support, please check that the items below are properly connected or set. In case of using a non-standard signal, please check the pin assignments and the signal timing of your computer with the specification outlined in Section 6. SPECIFICATIONS.

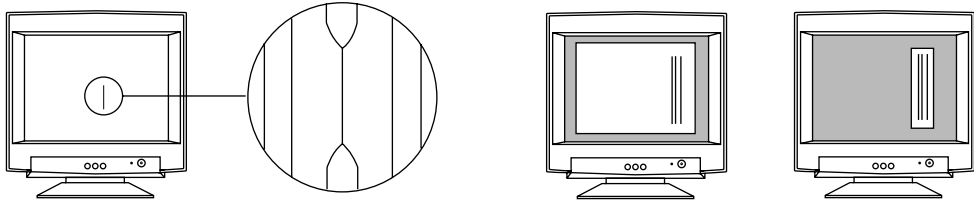
PROBLEM		ITEMS TO CHECK	LOCATION
No picture	LED On (Green)	<ul style="list-style-type: none"> • Contrast and brightness controls 	<ul style="list-style-type: none"> • Front (OSD)
	LED Off	<ul style="list-style-type: none"> • Power switch • AC power cord disconnected 	<ul style="list-style-type: none"> • Front • Rear
	LED On (Orange)	<ul style="list-style-type: none"> • Signal cable disconnected • Computer power switch • Power management function is active. 	<ul style="list-style-type: none"> • Rear • Computer • Press any key on the keyboard or move the mouse.
	LED Blinking (Orange)	<ul style="list-style-type: none"> • Power switch <p>NOTE Due to fine dusts existing in the inside of CRT, a discharge may occur at the CRT. When the discharge occur, the monitor may turn off automatically. This is by an internal protection circuit operated and it is to avoid electrical components broken.</p>	<ul style="list-style-type: none"> • Front
Abnormal picture	Display is missing, center shifts, or too small or too large of a display size	<ul style="list-style-type: none"> • Press "-" and "+" button together, to restore to the factory preset. • Adjust Horizontal size, Vertical size, Horizontal position, and Vertical position with non - standard signals. • Monitor may not be able to get full-screen image depend on signal. In this case, please select other resolution, or other vertical refresh timing. • Make sure you wait a few seconds after adjusting the size of the image before changing or disconnecting the signal. 	<ul style="list-style-type: none"> • Front (OSD) • Front (OSD)
	Black vertical lines are visible on the screen.	<ul style="list-style-type: none"> • Thin vertical black lines on one or both sides of the screen. This minor condition is caused by grille element overlap which can occur during shipping. • Position an open white window over the affected area of the screen and maximize the brightness and contrast controls. This will cause localized heating of the overlap which will clear in a few minutes. Be sure to readjust the brightness and contrast controls back to the normal viewing levels after this procedure. 	

PROBLEM	ITEMS TO CHECK	LOCATION
<p>Two fine horizontal lines are visible on the screen.</p>	<ul style="list-style-type: none"> The 2 very faint thin lines across the screen are normal. They are caused by the aperture grille stabilization filaments(Damper Wires) which are required for all aperture grille CRTs'. 	
<p>A buzzing sound when power on.</p>	<ul style="list-style-type: none"> A brief vibration or hum sound that is heard just after power up is normal. This is caused by the automatic degaussing function. This sound will be heard each time the monitor is powered up from a cold start and each time the manual degauss button is used. 	

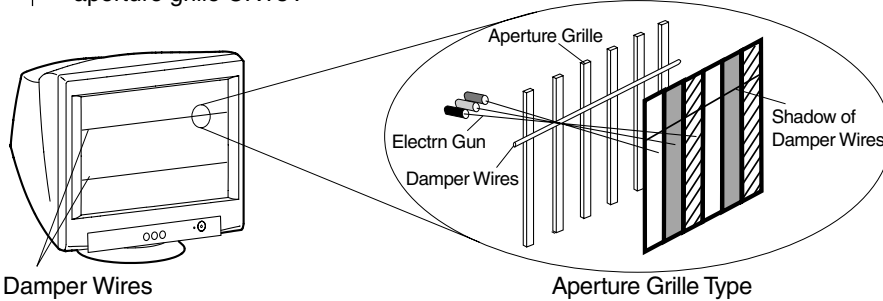

6 SPECIFICATIONS

CRT	Size	43cm/17" (41cm/16" Viewable Image Size)	
	Mask type	Aperture grille	
	Gun	In-line	
	Deflection angle	90°	
	Phosphors	Red, Green, Blue EBU (medium short persistence)	
	Aperture grille pitch	0.25mm	
	Face Plate	Anti-glare, Anti-reflection and Anti-static film	
	Focusing method	Dynamic Beam Forming (DBF)	
INPUT SIGNAL	Video	0.7V analog RGB	
	Sync	Separate H, V sync., or Composite sync	
SIGNAL INTERFACE	Input Connectors	DB9-15P	
	Input Impedance	75Ω (video), 2.2kΩ(sync.)	
SCANNING FREQUENCY	Horizontal	31 - 70kHz	
	Vertical	55 - 120Hz	
RESOLUTION (HxV)	1280 dots x 1024 lines Non-Interlaced maximum addressable resolution format at 75Hz		
WARM-UP TIME	30 minutes to reach optimum performance level		
BRIGHTNESS	100cd/m ² , standard full white video signal at 9300K (+ 8MPCD)		
BLANKING TIME	Horizontal	≥ 3.6 μsec (typ.)	
	Vertical	≥ 530 μsec (typ.)	
DISPLAY SIZE	310mm x 232mm(typ.)	ratio 4:3	
COLOUR	5000K~9300K		
POWER SOURCE	AC100-240V±10% 50/60Hz 73W (typ.)		
OPERATING ENVIRONMENT	Temperature	10 - 35°C	
	Humidity	30 - 80%RH (without condensation)	
DIMENSIONS	(W)15.9inch x (H)16.5inch x (D)16.5inch / (W) 403mm x (H) 420mm x (D) 420mm		
WEIGHT	Approx. 16.4kg / 36.2lbs.		
TILT/SWIVEL BASE	Tilt Angle	-5° - +10°	
REGULATIONS	Safety	UL1950 (UL), CSA C22.2 No.950 (C-UL) EN60950 (TÜV-GS)	
	EMC	FCC Class-B, DOC Class-B EN55022 Class-B, AS/NZS 3548 Class-B EN50082-1, EN61000-3-2, EN61000-3-3, EN55024	
	X-Ray	DHHS, HWC, Röv vom 8.1, 1987	
	Other	CE-Marking, MPR-II/TCO'91 ISO9241-3, ISO9241-7, ISO9241-8 (TÜV-GS) TCO '99 International ENERGY STAR Program	

* This monitor is registered / certified with Model No. N0701.

7 WARRANTY

IMPORTANT

Please keep this Warranty in a safe place.
It is valuable.

The benefits conferred by this Warranty are in addition to all other rights and remedies in respect of the product which the consumer has under the Trade Practices Act and similar State and Territory Laws.



PC and GRAPHIC
MONITORS

3 YEAR WARRANTY

Please complete and keep with original purchase docket.

OWNER'S NAME:

ADDRESS:

CITY: STATE: POSTCODE:

MODEL No: SERIAL No:

DATE OF PURCHASE:

INVOICE/SALES DOCKET No:

RETAILER'S NAME:

ADDRESS:

CITY: STATE: POSTCODE:

OWNER RESPONSIBILITY

Before you request repair to the product under this Warranty please check the following to save you unnecessary expense. You will have to pay for attention to and correction of all faults or problems not related to the product.

POWER: Check that the power plug is pushed in and the power is switched on. If there is still no power check whether there is power at the power point by using another appliance.

USER CONTROLS: Ensure that they are set in accordance with the instructions in the Owner's Instruction Manual.

INSTALLATION: Make sure your product is correctly installed.

INPUT SIGNAL: Check that the input signal is connected and is the correct type for this product.

RELOCATION: This Warranty does not cover relocation or re-installation and set up of the product.

BATTERIES: This Warranty does not apply if the product is damaged by the use of exhausted, leaking or used batteries or fails to function correctly as a result of the use of such batteries.

1. This Warranty:

- a) covers the product described above against labour and faulty materials for a period of **three (3) years** from the date of purchase.
- b) covers replacement parts and repair labour provided under this Warranty for the remainder of the period of warranty for the product into which they are incorporated or applied.
- c) only covers the product if purchased in Australia and operated in Australia or its Territories.
- d) does not cover any consumable including accessories supplied with the product unless such item is shown to be defective when the product is first purchased by the consumer.
- e) does not cover relocation or re-installation and set up of the product.

2. This Warranty will not apply if:

- a) the product is damaged by the use of an accessory which is not supplied by Mitsubishi Electric Australia.

- b) the product is damaged by the use of a consumable which is not supplied by Mitsubishi Electric Australia or its recognised retailer and which consumable is not of an equivalent standard and quality.
- c) the product is damaged by exhausted, leaking or used batteries or fails to function correctly as a result of the use of such batteries.
- d) the product case is opened by a person other than Mitsubishi Electric Australia's recognised retailer or repairer, or the recognised retailer's repair agent.
- e) the cathode ray tube exhibits a burned-in image due to continued use without an effective PC screen saver.

3. Under this Warranty:

- a) product defects covered by this Warranty will be repaired, during normal business hours, at the premises of Mitsubishi Electric Australia's recognised retailer or repairer, or the recognised retailer's repair agent without cost to the owner for parts and repair labour or, at the option of Mitsubishi Electric Australia, the product will be replaced. (Contact the Mitsubishi Electric Australia office in your State for details of recognised repairers).
- b) the owner is responsible for all transport costs and intransit insurance costs if the product or part has to be returned for repair to Mitsubishi Electric Australia's recognised retailer or repairer, or the recognised retailer's repair agent. Whenever possible, the product should be returned in its original carton and packing or alternatively in packing suitable to prevent damage to the product. Mitsubishi Electric Australia will not accept responsibility for damage to the product caused by unsuitable or inadequate packing.
- c) the owner is at all times responsible for the repair of defects caused by accidental or intentional damage, improper voltage, fire, misuse, abuse, neglect, alterations by or negligence of the consumer, incorrect or incomplete installation or operation by the consumer, Acts of God, vermin or foreign matter entering the product, e.g. dirt and moisture. The OWNER RESPONSIBILITY list is provided to help in this regard. Refer to the Owner's Instruction Manual for operation and other information.

4. For repair of the product under this Warranty:

- a) the retailer or repairer should be contacted within thirty (30) days of the fault developing.
- b) this Warranty with the original purchase docket must be presented to Mitsubishi Electric Australia's recognised retailer or repairer or the recognised retailer's repair agent.

5. Various warranties or conditions may be implied or obligations may be imposed on Mitsubishi Electric Australia by provisions of the Trade Practices Act 1974 and other laws in force in Australia. If any such provision applies, then to the extent permitted by law and to the extent that this Warranty is given in addition to such warranties or conditions, any liability under this Warranty is expressly limited to:

- a) in the case of products, the replacement of the product, the payment of the cost of replacing the product or of acquiring an equivalent product, at the discretion of Mitsubishi Electric Australia; and
- b) in the case of services, supplying the services again or the payment of the cost of having the services supplied again, at the discretion of Mitsubishi Electric Australia.

6. This is the only Warranty given by Mitsubishi Electric Australia on this product. No other person or non-statutory organisation is authorised by Mitsubishi Electric Australia to vary the provisions and conditions of this Warranty.

IMPORTANT NOTICE

This recycle symbol may appear on packaging material or components of this product.

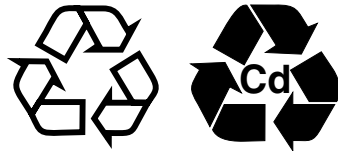

This symbol is a mandatory requirement in some countries and does not necessarily indicate that the material can be recycled in Australia. The Plastic Identification Code (numbers 1 to 7 in a “chasing arrows triangle”) may also appear on packaging material or components for this product.



This symbol is designed to identify the resin type used in the manufacture of the material on which it appears. It does not indicate that the material is recyclable.

If you have any questions on the recyclability of any materials please contact the Mitsubishi Electric Australia office in your state.

MITSUBISHI ELECTRIC AUSTRALIA PTY. LTD.

(INCORPORATED IN NEW SOUTH WALES)

A.B.N. 58 001 215 792

New South Wales

348 Victoria Road,
Rydalmere NSW 2116
Phone: (02) 9684 7777

Queensland

Unit 1, 104 Newmarket Road,
Windsor QLD 4030
Phone: (07) 3357 8877

Western Australia

Unit 5, 329 Collier Road,
Bassendean WA 6054
Phone: (08) 9377 3400

**South Australia/
Northern Territory**

77 Port Road,
Hindmarsh SA 5007
Phone: (08) 8340 2000

**Victoria/
Tasmania**

Unit 4, 303 Burwood Highway,
East Burwood VIC 3151
Phone: (03) 9262 9855

www.mitsubishi-electric.com.au

15500991

Declaration of Conformity - United States only

Product Name: 17 in. (43cm) Color Display Monitor
Type: N0701
Brand Name: MITSUBISHI

This device complies with Part 15 of the FCC Rules. Operation is subject to the following two conditions: (1) this device may not cause harmful interference, and (2) this device must accept any interference received, including interference that may cause undesired operation.

For questions regarding this declaration, contact:
NEC-Mitsubishi Electronics Display of America, Inc.
1250 North Arlington Heights Road,
Itasca, Illinois 60143-1248

or, call
(630) 467-3000

To identify this product, refer to the model number found on the product.

As an ENERGY STAR Partner, NEC-Mitsubishi Electric Visual Systems Corporation has determined that this product meets the ENERGY STAR guidelines for energy efficiency.