MultiSync FE1250+

User's Manual

NEC

For the Customer to use in U.S.A. or Canada

Canadian Department of Communications Compliance Statement

DOC: This Class B digital apparatus meets all requirements of the Canadian Interference-Causing Equipment Regulations.

C-UL: Bears the C-UL Mark and is in compliance with Canadian Safety Regulations according to CSA C22.2 #950.

FCC Information

1. Use the attached specified cables with the MultiSync NSV1117STTKW colour monitor so as not to interfere with radio and television reception.
 - (1) Please use the supplied power cable or equivalent to ensure FCC compliance.
 - (2) Shielded captive type signal cable.
Use of other cables and adapters may cause interference with radio and television reception.
2. This equipment has been tested and found to comply with the limits for a Class B digital device, pursuant to part 15 of the FCC Rules. These limits are designed to provide reasonable protection against harmful interference in a residential installation. This equipment generates, uses, and can radiate radio frequency energy, and, if not installed and used in accordance with the instructions, may cause harmful interference to radio communications. However, there is no guarantee that interference will not occur in a particular installation. If this equipment does cause harmful interference to radio or television reception, which can be determined by turning the equipment off and on, the user is encouraged to try to correct the interference by one or more of the following measures:
 - Reorient or relocate the receiving antenna.
 - Increase the separation between the equipment and receiver.
 - Connect the equipment into an outlet on a circuit different from that to which the receiver is connected.
 - Consult your dealer or an experienced radio/TV technician for help.

If necessary, the user should contact the dealer or an experienced radio/television technician for additional suggestions. The user may find the following booklet, prepared by the Federal Communications Commission, helpful: "How to Identify and Resolve Radio-TV Interference Problems." This booklet is available from the U.S. Government Printing Office, Washington, D.C., 20402, Stock No. 004-000-00345-4.

No user serviceable parts inside. Do not attempt to modify this equipment. If modified, your authority to operate this equipment might be voided by FCC.

VCCI Statement

この装置は、情報処理装置等電波障害自主規制協議会(VCCI)の基準に基づくクラスB情報技術装置です。この装置は、家庭環境で使用することを目的としていますが、この装置がラジオやテレビジョン受信機に近接して使用されると、受信障害を引き起こすことがあります。

取扱説明書に従って正しい取り扱いをしてください。

Declaration

Declaration of the Manufacturer

We hereby certify that the color monitor
MultiSync FE1250+ (NSV1117STTKW) is in
compliance with Council Directive 73/23/EEC:

- EN 60950

Council Directive 89/336/EEC:

- EN 55022

- EN 61000-3-2

- EN 61000-3-3

- EN 55024

and marked with



NEC-Mitsubishi Electric Visual Systems Corporation
4-13-23, Shibaura,
Minato-Ku
Tokyo 108-0023, JAPAN

Safety Instruction



WARNING



TO PREVENT FIRE OR SHOCK HAZARDS, DO NOT EXPOSE THIS UNIT TO RAIN OR MOISTURE. ALSO, DO NOT USE THIS UNIT'S POLARIZED PLUG WITH AN EXTENSION CORD RECEPTACLE OR OTHER OUTLETS UNLESS THE PRONGS CAN BE FULLY INSERTED. REFRAIN FROM OPENING THE CABINET AS THERE ARE HIGH VOLTAGE COMPONENTS INSIDE. REFER SERVICING TO QUALIFIED SERVICE PERSONNEL.

CAUTION



RISK OF ELECTRIC SHOCK • DO NOT OPEN



CAUTION

TO REDUCE THE RISK OF ELECTRIC SHOCK, MAKE SURE POWER CORD IS UNPLUGGED FROM WALL SOCKET. TO FULLY DISENGAGE THE POWER TO THE UNIT, PLEASE DISCONNECT THE POWER CORD FROM THE AC OUTLET. DO NOT REMOVE COVER (OR BACK). NO USER SERVICEABLE PARTS INSIDE. REFER SERVICING TO QUALIFIED SERVICE PERSONNEL.



This symbol warns user that uninsulated voltage within the unit may have sufficient magnitude to cause electric shock. Therefore, it is dangerous to make any kind of contact with any part inside this unit.



This symbol alerts the user that important literature concerning the operation and maintenance of this unit has been included. Therefore, it should be read carefully in order to avoid any problems.

ENERGY STAR® is a U.S. registered trademark. All other brands and product names are trademarks or registered trademarks of their respective owners.

As an ENERGY STAR Partner, NEC-Mitsubishi Electric Visual Systems Corporation has determined that this product meets the ENERGY STAR guidelines for energy efficiency.

The ENERGY STAR emblem does not represent EPA endorsement of any product or service.

All other trademarks mentioned in this manual are the property of their respective owners.

TCO'99

Congratulations! You have just purchased a TCO'99 approved and labeled product! Your choice has provided you with a product developed for professional use. Your purchase has also contributed to reducing the burden on the environment and also to the further development of environmentally adapted electronics products.



Why do we have environmentally labelled computers?

In many countries, environmental labelling has become an established method for encouraging the adaptation of goods and services to the environment. The main problem, as far as computers and other electronics equipment are concerned, is that environmentally harmful substances are used both in the products and during their manufacture. Since it is not so far possible to satisfactorily recycle the majority of electronics equipment, most of these potentially damaging substances sooner or later enter nature.

There are also other characteristics of a computer, such as energy consumption levels, that are important from the viewpoints of both the work (internal) and natural (external) environments. Since all methods of electricity generation have a negative effect on the environment (e.g. acidic and climate-influencing emissions, radioactive waste), it is vital to save energy. Electronics equipment in offices is often left running continuously and thereby consumes a lot of energy.

What does labelling involve?

This product meets the requirements for the TCO'99 scheme which provides for international and environmental labelling of personal computers. The labelling scheme was developed as a joint effort by the TCO (The Swedish Confederation of Professional Employees), Svenska Naturskyddsforeningen (The Swedish Society for Nature Conservation) and Statens Energimyndighet (The Swedish National Energy Administration).

Approval requirements cover a wide range of issues: environment, ergonomics, usability, emission of electric and magnetic fields, energy consumption and electrical and fire safety.

The environmental demands impose restrictions on the presence and use of heavy metals, brominated and chlorinated flame retardants, CFCs (freons) and chlorinated solvents, among other things. The product must be prepared for recycling and the manufacturer is obliged to have an environmental policy which must be adhered to in each country where the company implements its operational policy.

The energy requirements include a demand that the computer and/or display, after a certain period of inactivity, shall reduce its power consumption to a lower level in one or more stages. The length of time to reactivate the computer shall be reasonable for the user.

Labelled products must meet strict environmental demands, for example, in respect of the reduction of electric and magnetic fields, physical and visual ergonomics and good usability.

Below you will find a brief summary of the environmental requirements met by this product. The complete environmental criteria document may be ordered from:

TCO Development

SE-114 94 Stockholm, Sweden

Fax: +46 8 782 92 07

Email (Internet): development@tco.se

Current information regarding TCO'99 approved and labelled products may also be obtained via the Internet, using the address:

<http://www.tco-info.com/>

Environmental requirements

Flame retardants

Flame retardants are present in printed circuit boards, cables, wires, casings and housings. Their purpose is to prevent, or at least to delay the spread of fire. Up to 30% of the plastic in a computer casing can consist of flame retardant substances. Most flame retardants contain bromine or chloride, and those flame retardants are chemically related to another group of environmental toxins, PCBs. Both the flame retardants containing bromine or chloride and the PCBs are suspected of giving rise to severe health effects, including reproductive damage in fish-eating birds and mammals, due to the bio-accumulative* processes. Flame retardants have been found in human blood and researchers fear that disturbances in foetus development may occur.

The relevant TCO'99 demand requires that plastic components weighing more than 25 grams must not contain flame retardants with organically bound bromine or chlorine. Flame retardants are allowed in the printed circuit boards since no substitutes are available.

Cadmium**

Cadmium is present in rechargeable batteries and in the colour-generating layers of certain computer displays. Cadmium damages the nervous system and is toxic in high doses. The relevant TCO'99 requirement states that batteries, the colour-generating layers of display screens and the electrical or electronics components must not contain any cadmium.

Mercury**

Mercury is sometimes found in batteries, relays and switches. It damages the nervous system and is toxic in high doses. The relevant TCO'99 requirement states that batteries may not contain any Mercury. It also demands that no mercury is present in any of the electrical or electronics components associated with the labelled unit.

CFCs (freons)

The relevant TCO'99 requirement states that neither CFCs nor HCFCs may be used during the manufacturing and assembly of the product. CFCs (freons) are sometimes used for washing printed circuit boards. CFCs break down ozone and thereby damage the ozone layer in the stratosphere, causing increased reception on Earth of ultraviolet light with e. g. increased risks of skin cancer (malignant melanoma) as a consequence.

Lead**

Lead can be found in picture tubes, display screens, solders and capacitors. Lead damages the nervous system and in higher doses, causes lead poisoning. The relevant TCO'99 requirement permits the inclusion of lead since no replacement has yet been developed.

*Bio-accumulative is defined as substances which accumulate within living organisms.

**Lead, Cadmium and Mercury are heavy metals which are Bio-accumulative.

Contents

Your new MultiSync FE1250+ monitor box* should contain the following:

- MultiSync FE1250+ Monitor with tilt/swivel base
- Power cord
- Captive Signal Cable
- User's Manual
- CD-ROM:
Includes complete User's Manual in PDF format and Windows related files (Inf file and color profile). To see the complete User's Manual, Acrobat Reader 4.0 must be installed at your PC.

User's Manual



Power Cord

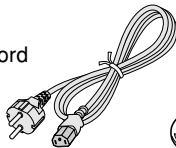

CD-ROM

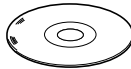

Captive Signal Cable

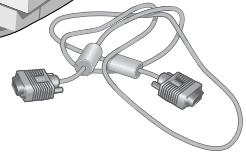

- * Remember to save your original box and packing material to transport or ship the monitor.

Quick Start

To attach the MultiSync FE1250+ monitor to your system, follow these instructions:

1. Turn off the power to your computer.
2. If necessary, install the display card into your system. For more information, refer to the display card manual.
3. **For the PC:** Connect the 15-pin mini D-SUB of the captive signal cable to the connector of the display card in your system (**Figure A.1**). Tighten all screws.

For the Mac: Connect the Macintosh cable adapter (not included) to the monitor connector on the Macintosh (**Figure B.1**). Attach the 15-pin mini D-SUB end of the captive signal cable to the Macintosh cable adapter on the computer (**Figure B.1**). Tighten all screws.

4. The Windows® 95/98/2000 INF file for your MultiSync monitor can be found on the CD-ROM, delivered with the monitor.
5. Connect one end of the power cord to the MultiSync FE1250+ monitor and the other end to the power outlet (**Figure C.1**).
6. Turn on the monitor (**Figure D.1**) and the computer.

NOTE: If you have any problems, please refer to the **Troubleshooting** section of this User's Manual.

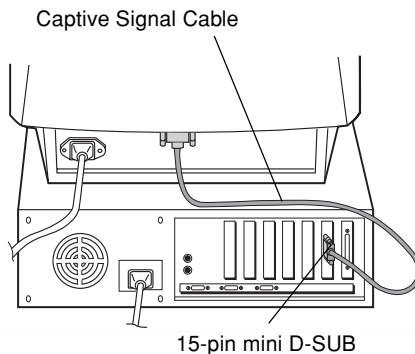

Figure A.1

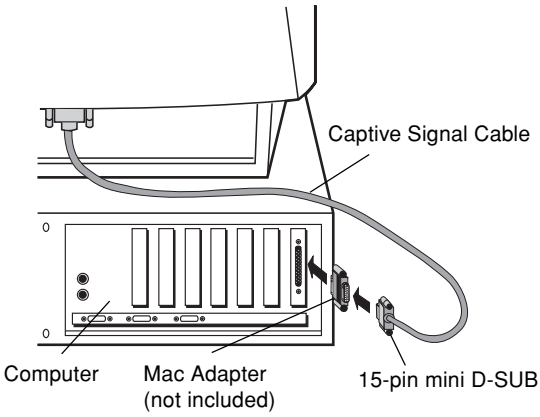

Figure B.1

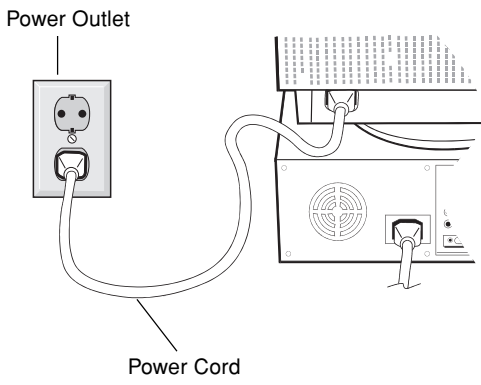

Figure C.1

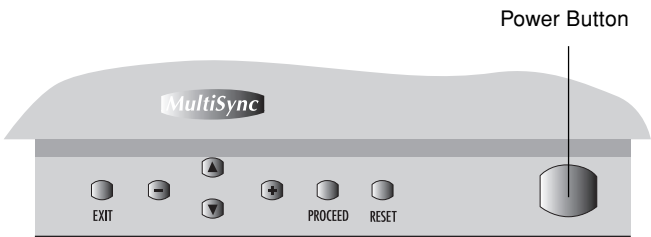

Figure D.1

Controls

OSM (On-Screen Manager) control buttons on the front of the monitor function as follows:

	Main Menu	Sub-Menu
EXIT	Exits the OSM menu.	Exits to the OSM main menu.
CONTROL ▲/▼	Moves the highlighted area up/down to select one of the controls.	Moves the highlighted area up/down to select one of the controls.
CONTROL -/+	Moves highlighted area left/right to select one of the controls.	Moves the bar in the - or + direction to decrease or increase the adjustment.
PROCEED	Has no function.	Only executes control or enters sub-menu.
RESET	Resets all the controls within the highlighted menu to the factory setting.	Resets the highlighted control to the factory setting.

NOTE: When **RESET** is pressed in the main and sub-menu, a warning window will appear allowing you to cancel the reset function.

When OSM controls are activated, icons are displayed at the top of the menu. If an arrow (→) is displayed in a sub-menu, it indicates further choices are available. To enter a sub-menu, press **PROCEED**.

Brightness/Contrast Controls

Brightness: Adjusts the overall image and background screen brightness.

Contrast: Adjusts the image brightness in relation to the background.

Degauss: Eliminates the build-up of stray magnetic fields which alter the correct scan of the electron beams and affect the purity of the screen colours, focus, and convergence. When activated, your screen image will jump and waver a bit as the screen is demagnetised.

Caution: Please allow a minimum of 20 minutes to elapse between uses of the Degauss function.



Size and Position Controls

Left/Right: Moves the image horizontally (left or right).

Down/Up: Moves the image vertically (up or down).

Narrow/Wide: Decreases or increases the horizontal size of the image.

Short/Tall: Decreases or increases the vertical size of the image.



Color Control/Color Control System

Color presets 1 through 5 selects the desired color setting. The bar is replaced by the color setting choice. Each color setting is adjusted at the factory to the stated Kelvin. If a setting is adjusted, the name of the setting will change from Kelvin to Custom.

Red, Green, Blue: AccuColor Control System decreases or increases the monitor's red, green or blue color guns depending upon which is selected. The change in color will appear on screen and the direction (decrease or increase) will be shown by the bars.

sRGB Mode: sRGB mode provides the suitable color managed picture image. You can not change Contrast, Brightness, Red, Green and Blue colors individually.



Geometry Controls

Geometry Controls Menu

The **Geometry** controls allow you to adjust the curvature or angle of the sides of your display.

Sides In/Out (pincushion): Decreases or increases the curvature of the sides either inward or outward.

Sides Left/Right (pincushion balance): Decreases or increases the curvature of the sides either to the left or right.

Sides Tilt (parallelogram): Decreases or increases the tilt of the sides either to the left or right.

Sides Align (trapezoidal): Decreases or increases the bottom of the screen to be the same as the top.

Rotate (raster rotation): Rotates the entire display clockwise or counterclockwise.



Size and Position Controls

Left/Right: Moves the image horizontally (left or right).

Down/Up: Moves the image vertically (up or down).

Narrow/Wide: Decreases or increases the horizontal size of the image.

Short/Tall: Decreases or increases the vertical size of the image.



Color Control/Color Control System

Color presets 1 through 5 selects the desired color setting. The bar is replaced by the color setting choice. Each color setting is adjusted at the factory to the stated Kelvin. If a setting is adjusted, the name of the setting will change from Kelvin to Custom.

Red, Green, Blue: AccuColor Control System decreases or increases the monitor's red, green or blue color guns depending upon which is selected. The change in color will appear on screen and the direction (decrease or increase) will be shown by the bars.

sRGB Mode: sRGB mode provides the suitable color managed picture image. You can not change Contrast, Brightness, Red, Green and Blue colors individually.



Geometry Controls

Geometry Controls Menu

The **Geometry** controls allow you to adjust the curvature or angle of the sides of your display.

Sides In/Out (pincushion): Decreases or increases the curvature of the sides either inward or outward.

Sides Left/Right (pincushion balance): Decreases or increases the curvature of the sides either to the left or right.

Sides Tilt (parallelogram): Decreases or increases the tilt of the sides either to the left or right.

Sides Align (trapezoidal): Decreases or increases the bottom of the screen to be the same as the top.

Rotate (raster rotation): Rotates the entire display clockwise or counterclockwise.

Auto Save: The monitor automatically saves the last settings of the user controls. You can turn this Auto Save feature off by selecting this menu and changing the off position. When the off mode is selected, you will be prompted with the option to save or return to the previous setting once you select a different control. If the save is not confirmed, the setting will go back to the previous setting when OSM is turned off.

Factory Preset: Selecting Factory Preset allows you to reset most OSM control settings back to the factory settings. A warning statement will appear to confirm that you do want to reset ALL settings. Individual settings can be reset by highlighting the control to be reset and pressing the **RESET** button.

Tools 2

Language: OSM controls menus are available in six languages.

OSM Position: You can choose where you would like the OSM controls menu to appear on your screen. Selecting OSM Position allows you to manually adjust the OSM controls menu position from among Center, Top left, Top right, Bottom left and Bottom right.

OSM Turn Off: The OSM controls menu will stay on as long as it is in use. In the OSM Turn Off sub-menu, you can select how long the monitor waits after the last touch of a button for the OSM controls menu to disappear. The preset choices are 10, 20, 30, 45, 60 and 120 seconds.

OSM Lock Out: This control completely locks out access to all OSM controls functions except Brightness and Contrast. When attempting to activate OSM controls while in the lock out mode, a screen will appear indicating that OSM controls are locked out. To activate the OSM Lock Out function, press PROCEED, then press ▲ and hold down simultaneously. To deactivate the OSM Lock Out, press PROCEED, then press ▲ and hold down simultaneously.

IPM System Off Mode:

Enable: The IPM System works normally and all stages of energy savings are utilized.

Disable: The Off Mode of the IPM System is not used.

NOTE: For standard systems and graphics boards, keep the factory setting at ENABLE.



Information

Display Mode: Indicates the current mode and frequency setting of the monitor.

Monitor Info: Indicates the model and serial numbers of your monitor.

Refresh Notifier: A message will advise you if the refresh rate of the signal being applied to the monitor by the computer is too low. For further information, please refer to your display card or system manual.

Recommended use

Safety Precautions and Maintenance:



FOR OPTIMUM PERFORMANCE, PLEASE NOTE THE FOLLOWING WHEN SETTING UP AND USING THE MULTISYNC FE1250+ COLOR MONITOR:



- **DO NOT OPEN THE MONITOR.** There are no user serviceable parts inside and opening or removing covers may expose you to dangerous shock hazards or other risks. Refer all servicing to qualified service personnel.
- Do not spill any liquids into the cabinet or use your monitor near water.
- Do not insert objects of any kind into the cabinet slots, as they may touch dangerous voltage points, which can be harmful or fatal or may cause electric shock, fire or equipment failure.
- Do not place any heavy objects on the power cord. Damage to the cord may cause shock or fire.
- Do not place this product on a sloping or unstable cart, stand or table, as the monitor may fall, causing serious damage to the monitor.
- Keep the monitor away from high capacity transformers, electric motors and other devices such as external speakers or fans, which may create strong magnetic fields.
- If possible, position the monitor so that it is facing the east to minimize the effects of the earth's magnetic field.
- Changing the direction of the monitor while it is powered on may cause image discoloration. To correct this, turn the monitor off for 20 minutes before powering it back on.
- When operating the MultiSync FE1250+ with its AC 100-120/220-240V worldwide power supply, use a power supply cord that matches the power supply voltage of the AC power outlet being used. The power supply cord you use must have been approved by and comply with the safety standards of your country. (Type H05VV-F should be used except in UK)
- In UK, use a BS-approved power cord with molded plug having a black (5A) fuse installed for use with this monitor. If a power cord is not supplied with this monitor, please contact your supplier.

Immediately unplug your monitor from the wall outlet and refer servicing to qualified service personnel under the following conditions:

- When the power supply cord or plug is damaged.
- If liquid has been spilled, or objects have fallen into the monitor.
- If the monitor has been exposed to rain or water.
- If the monitor has been dropped or the cabinet damaged.
- If the monitor does not operate normally by following operating instructions.



CAUTION

- Allow adequate ventilation around the monitor so that heat can properly dissipate. Do not block ventilated openings or place the monitor near a radiator or other heat sources. Do not put anything on top of monitor.
- The power cable connector is the primary means of detaching the system from the power supply. The monitor should be installed close to a power outlet which is easily accessible.
- Handle with care when transporting. Save packaging for transporting.



CORRECT PLACEMENT AND ADJUSTMENT OF THE MONITOR CAN REDUCE EYE, SHOULDER AND NECK FATIGUE. CHECK THE FOLLOWING WHEN YOU POSITION THE MONITOR:



- Adjust the monitor height so that the top of the screen is at or slightly below eye level. Your eyes should look slightly downward when viewing the middle of the screen.
- Position your monitor no closer than 40 cm and no further away than 60 cm from your eyes. The optimal distance is 70 cm.
- Rest your eyes periodically by focusing on an object at least 6 m away. Blink often.
- Position the monitor at a 90° angle to windows and other light sources to minimize glare and reflections. Adjust the monitor tilt so that ceiling lights do not reflect on your screen.
- If reflected light makes it hard for you to see your screen, use an anti-glare filter.
- Clean your monitor regularly. Use a lint-free, non-abrasive cloth and a non-alcohol, neutral, non-abrasive cleaning solution or glass cleaner to minimize dust.
- Adjust the monitor's brightness and contrast controls to enhance readability.
- Use a document holder placed close to the screen.
- Position whatever you are looking at most of the time (the screen or reference material) directly in front of you to minimize turning your head while you are typing.
- Get regular eye checkups.

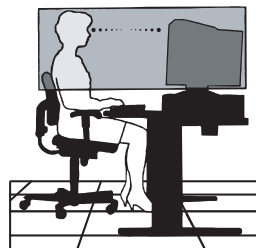

Ergonomics

To realize the maximum ergonomics benefits, we recommend the following:

- Adjust the Brightness until the background raster disappears
- Do not position the Contrast control to its maximum setting
- Use the preset Size and Position controls with standard signals
- Use the preset Color Setting and Sides Left/Right controls
- Use non-interlaced signals with a vertical refresh rate between 75-160Hz
- Do not use primary color blue on a dark background, as it is difficult to see and may produce eye fatigue due to insufficient contrast

Specifications

Monitor Specifications	MultiSync FE1250+	Notes
Picture Tube Viewable Image Size:	Diagonal: 55 cm/22 inch 50.8 cm/20 inch	90° deflection, 0.24 mm grill pitch, medium short persistence phosphor, aperture grille CRT, multi-layered, anti-static screen coating, dark-tint screen and OptiClear screen.
Input Signal	Video: ANALOG 0.7 Vp-p/75 Ohms Sync: Separate sync. TTL Level Horizontal sync. (Positive/Negative; TTL Level) Vertical sync. (Positive/Negative; TTL Level) Composite sync. (Positive/Negative; TTL Level)	
Display Colours	Analog input: Unlimited number of Colours	Depends on display card used.
Synchronization Range	Horizontal: 30 kHz to 110 kHz Vertical: 50 Hz to 160 Hz	Automatically Automatically
Resolutions Supported Resolution based on horizontal and vertical frequencies only	640 x 480 @ 60 to 160 Hz 800 x 600 @ 55 to 160 Hz 832 x 624 @ 55 to 160 Hz 1024 x 768 @ 55 to 136 Hz 1152 x 870 @ 55 to 120 Hz 1280 x 1024 @ 55 to 102 Hz 1600 x 1200 @ 55 to 88 Hz.... 1792 x 1344 @ 55 to 78 Hz 1800 x 1440 @ 55 to 73 Hz 1856 x 1392 @ 55 to 75 Hz 1920 x 1440 @ 55 to 73 Hz	Some systems may not support all modes listed. NEC cites recommended resolution at 85 Hz for optimal display performance.
Active Display Area (Factory setting)	Horizontal: 396 mm Vertical: 297 mm	Dependent upon signal timing used, and does not include border area.
Active Display Area (Full scan)	406 mm 305 mm	Dependent upon signal timing used, and does not include border area.
Power Supply	AC 100-120/220-240 V @ 50/60 Hz	
Current Rating	1.3A@100-120V, 0.6A@220-240V	
Dimensions	495 mm (W) x 493.5 mm (H) x 473 mm (D) 19.8" (W) x 19.7" (H) x 18.9" (D)	
Weight	29.7 kg/65.5 lbs	
Environmental Considerations	Operating Temperature: 10 °C to +35 °C Humidity: 30% to 80% Altitude: 0 to 3000 m Storage Temperature: -20 °C to +60 °C Humidity: 10% to 90% Altitude: 0 to 15000 m	

NOTE: Technical specifications are subject to change without notice.

Features

Flat Aperture Grille CRT: Delivers an unparalleled viewing experience with a virtually flat image, eliminating distortion and reducing glare so that what you see on-screen is what you get on your printed output. The striped phosphor alignment of the CRT delivers superior vertical definition with improved bright-ness for more uniform image contrast.

OptiClear Screen Surface: Reduces reflection and glare and increases contrast without sacrificing focus level, clarity or brightness. Along with the flat square technology CRT, a high contrast screen with 0.24 mm grille pitch delivers crisp, clean text and graphics.

Dual Dynamic Beam Focus: Provides precise, continuous focus adjustments of the electron beams and optimum image quality, even to the far edges of the screen.

Color Control System: Allows you to change between five color settings on your display to match your personal preference.

OSM (On-Screen Manager) Controls: Allows you to quickly and easily adjust all elements of your screen image via simple to use on-screen menus.

ErgoDesign Features: Enhances human ergonomics to improve the working environment, protect the health of the user and save money. Examples include OSM controls for quick and easy image adjustments, tilt/swivel base for pre-ferred angle of vision and compliance with MPRII guidelines for lower emissions.

Plug and Play: The Microsoft® solution with the Windows® 95/98/2000 operating system facilitates setup and installation by allowing the monitor to send its capabilities (such as screen size and resolutions supported) directly to your computer, automatically optimizing display performance.

IPM (Intelligent Power Manager) System: Provides innovative power-saving methods that allow the monitor to shift to a lower power consumption level when on but not in use, saving two-thirds of your monitor energy costs, reducing emissions and lowering the air conditioning costs of the workplace.

Reduced Magnetic Field Technology: Reduces magnetic and alternating electric field emissions and static electricity, addressing ergonomic concerns regarding potential risks from extended computer monitor use.

Multiple Frequency Technology: Automatically adjusts monitor to the display card's scanning frequency, thus displaying the resolution required.

FullScan Capability: Allows you to use the entire screen area in most resolutions, significantly expanding image size.

GlobalSync/Corner Purity Control: Allows you to easily adjust impurities in the four corners of your monitor.

GTF Auto Adjust: Allows you to easily and quickly adjust the suitable horizontal and vertical size and position settings.

Convergence Control: Allows you to adjust the horizontal and vertical convergence of the top and bottom area to ensure that a white line drawn on the screen is as crisp and clear as possible.

Troubleshooting

No picture

- Display card should be completely seated in its slot.
- Power Button and computer power switch should be in the ON position.
- Signal cable should be completely connected to display card/ computer.
- Check connector for bent or pushed-in pins.

Image is scrolling or unstable

- Signal cable should be completely attached to the computer.
- Check pin assignments and signal timings of the monitor and your display card with respect to recommended timings and pin assignments.
- If the Macintosh cable adapter is used, check for proper connection or make sure the display card is Macintosh compatible and that the card is properly seated in the computer.

LED on monitor is not lit (no green or orange color can be seen)

- Power Switch should be in the ON position and power cord should be connected.

Picture is fuzzy or color looks blotchy

- If the picture is fuzzy, adjust the Moire Canceler Control. If the color looks blotchy, adjust the Brightness, Contrast or GlobalSync Controls, or use the EdgeLock control to change modes.
- Access the Degauss Control through OSM controls. Activate the Degauss Control.

CAUTION: A minimum interval of 20 minutes should elapse before the Degauss Control is used a second time when not switching between modes.

Picture bounces or a wavy pattern is present in the picture

- Move electrical devices that may be causing electrical interference away from the monitor.

Edges of the display image are not square

- Use the OSM Geometry Controls to straighten the edges.
- If possible, position the front of the monitor facing east.

Display image is not centered, too small, or too large

- Use the OSM Size and Position Controls to adjust the image.

Thin horizontal lines appear on your screen

- Thin horizontal lines are normal for an aperture grille CRT and are not a malfunction. These are shadows from the damper wires used to stabilize the aperture grille and are most noticeable when the screen's background is light (usually white).

Black vertical lines are visible on the screen

- Thin vertical black lines on one or both sides of the screen. This minor condition is caused by grille element overlap which can occur during shipping.
- Position an open white window over the affected area of the screen and maximize the brightness and contrast controls. This will cause localized heating of the overlap which will clear in a few minutes. Be sure to readjust the brightness and contrast controls back to the normal viewing level after this procedure.