

TANDY LAPTOP COMPUTING

NOVEMBER 1992 -VOL. 9, NO. 8

TERRY KEPNER'S

portable 100

\$3.95/CAN \$4.95

A MONTHLY PUBLICATION (EXCEPT COMBINED JULY/AUGUST ISSUE)

Balancing Your Books

QuickBooks
to the Rescue

Teacher's Pet
The Model 100
in the Classroom

**Telemarketing
With the M100**

MS-DOS 5
Three books to keep
you on an even keel

CHAOS
Order in the Universe
(or at least the M100)



XR4 IN THE "T"

Your option: Socket to me!
 \$169 for XR4, state M100 or T102,
 T200 model available early '93
 \$15 for software disk (advised),
 State format (TPDD, dos, Mac)
 \$5 shipping UPS blue or priority.
 Same day shipping!

128K
 RAM
 ROM

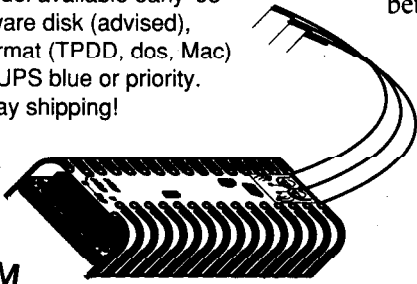

"Standard ROM" and "Option ROM" are side by side in the "basement" of the model T computer. The Tandy has a built-in switch that can flip very rapidly between them, kind of like opening a trap door at light speed into one of two basement rooms. ROM software uses this switching capability to endow the Tandy with enhanced capabilities for text processing, disk access, spreadsheet, database, programming, etc..

"ROM" stands for **Read Only Memory**. ROM software comes as chips you plug into the socket on the bottom of the computer.

Our 32k **extRAM**, introduced in 1989 and still available, offers a more flexible alternative: a RAM in the option ROM space. Being **RAM, Random Access Memory**, it can be updated and changed by software. Soft "images" of ROM chips can be loaded into the "option ROM space" from an external medium, e.g., disk or RAMPAC. The advantage is that the images can be rapidly changed. Images run from the extRAM just as they would from the original chip. It is easy using software we provide to dub images from your original chips (no pirating, please!!) and reload them as images.

You don't use ROMs? ExtRAM alternatively can serve as a **general purpose file-bank** for storing normal .BA, .DO and .CO files.

You can carry along twice as many of your utility programs or your work in progress, out on the road, 100% inside the computer.

Software we provide lets you take advantage of your unused option ROM space.

However, with extRAM, excellent as it is, you can have only one ROM image or file-bank at any given time at your fingertips inside the model T. Our customers asked us for more. They wanted to carry multiple ROM images and RAM file-banks, all hidden inside the computer, self sufficient, with nothing else to load from outside.

Enter the XR4, our proudest achievement! It is four extRAMs in one, a 128kbyte memory. Thanks to innovative packaging technology, it all fits inside the option ROM socket in less than 1/4 cubic inch, and draws less than 1 microamp from the model T's internal backup battery!

You can configure each of its **four banks** independently as **ROM-images**, or as **RAM-file-banks**. The **XR4MNU** program we provide allows you to **set the bank** of the XR4 that you need to be the Tandy's "option ROM" at any given time. With **ROM images** it allows you to **activate** or **deactivate** the images by name. With **RAM banks**, it shows you the bank's **file directory** and allows you to **load** and **save** files between XR4 and RAM (or even send files directly to a printer or to the serial port), **rename** and **kill** files, and even **swap workspaces** of files with one keystroke.

In the picture to the right, bank 4 of the **XR4** is shown active, with a ROM image installed. That ROM image works just like the chip it was dubbed from. Also shown is another ROM image in XR4 bank 3. Changing ROMs can be as simple as issuing the XR4 MNU commands to change banks. XR4 Banks 1 and 2 are shown here as general purpose RAM file banks, where you can store and retrieve ordinary .DO, .BA & .CO files.

XR4OPS is machine language code, hidden in the XR4 RAM banks, but not in the XR4 ROM banks. XR4MNU is built around "calls" to XR4 Hackers can enter XR4OPS commands directly from BASIC, and write original programs based on them. XR4OPS survives even "cold starts".

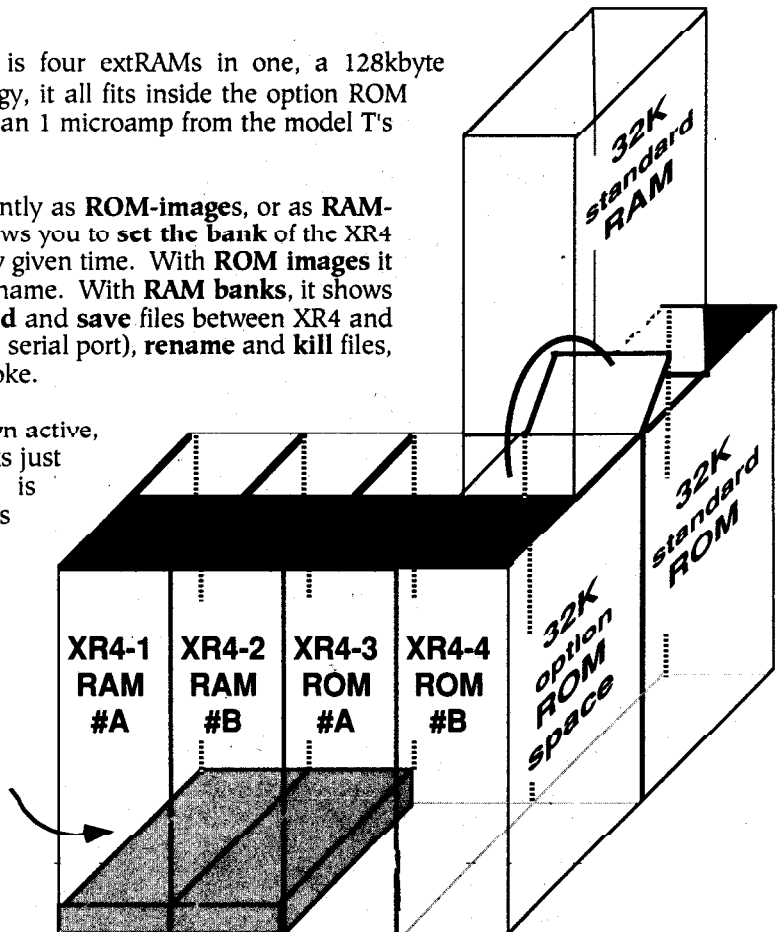

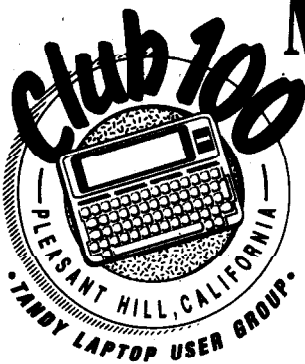

More Than Just a Laptop User Group

Supporting Tandy/Radio Shack Model 100, 102, 200 and WP-2 Computer Owners Since 1983

Lapdos II

Turn your Model 100/102/200/NEC8201 into a PC-partner. Connect your laptop computer or Tandy Portable Disk Drive directly to MS-DOS computers for file transfers at 19200 baud. Fast! Easy to use. Single or batch file transfers at the press of a button. Feature rich!

WP2DOS Plus

Turn your WP2 into a PC-partner. The only "file transfer" and "file conversion" software available or WP2 to DOS computer owners. Online utilities convert WP2 .DO files to popular DOS word processing file formats ... maintains file formatting codes. Super easy and fast.

WPduet

Turn your WP2 into a Mac-partner. Connect your laptop computer or Tandy Portable Disk Drive directly to Macintosh computers for file transfers at 19200 baud. Fast! Easy to use. Single or batch file transfers at the press of a button. Automatic file translations allow your Mac programs to use your laptop files, directly! Maintains file formatting codes.

100duet

Turn your Model 100/102 into a Mac-partner. Connect your laptop computer or Tandy Portable Disk Drive directly to Macintosh computer for file transfers at 19200 baud. Fast! Easy to use. Single or batch file transfers at the press of a button. Automatic file translations allow your Mac programs to use your laptop files, directly!

Power Pillow

Good-looking, powerful, long-lasting battery pack encased within an attractive black-vinyl holder provides hundreds of hours of battery life. Attaches to the back/bottom of your laptop with velcro (included). Hand crafted and tested. (Requires 4, "D" cell batteries, not included).

The Ultimate ROM II

Four programs in one make this more than just a "super" ROM.

T-WORD: overwrite/insert mode while editing, imbed print controls, control print output (margins, line spacing, page feeds, headers, footers, auto page numbering, bold face, underline, italics, mail merge, labels, and more), pixel-plot view of document before printing. **T-BASE:** true relational base operations, key field sorts, math, report generation, etc. **IDEAL:** outliner program for concept development. **VIEW 80:** see up to 60 characters per line while in TEXT, TELCOM and BASIC, fast processing, easy to read. **TS-DOS & SARDINE LINK:** automatically loads and runs TS-DOS and SARDINE from disk. (TS-DOS and SARDINE sold separately).

TS-DOS (ROM or Disk)

Super fast, easy access to your TPDD or TPDD2. Available for Models 100/102/200 and NEC8201. Features: file tagging, file printing direct from disk or RAM, direct access to disk drive from within BASIC or TEXT. Disk version works with the Ultimate ROM II or independently.

SARDINE (ROM or Disk)

Spell check your words. Fast, 33,000 word electronic spell check and dictionary. Corrections automatically inserted into text. ROM version includes T-word. Disk version works with the Ultimate ROM II or independently.

ROM2/Cleuseau

The very best programming tools available for Model 100/102/200 and NEC8201 laptop programmers. Two ROMs in one, and more. ROM2 is a full functioned 8085 macro assembler. Cleuseau adds much needed features to BASIC and TEXT. Call for full details.

Hard Cover

Protect the top of your 100/102/NEC8201 with a made-to-fit hard, black plastic cover. Looks good. Works great. WP2 protection cover available, too.

Keyboard Bands

Just the right size dental rubber bands necessary to almost eliminate Model 100/102/200 keyboard noise. Great for library and meeting use. Easy to install. Instructions included.

RAM, RAMPAC Storage, Multi-RAM/ROM

We have the widest selection of expansion RAM's, RAMPAC storage, and a device that can be used as extra RAM or as a multi-ROM bank. Exciting solutions!

Free BBS

Our free-2-use bulletin board computer is available 24 hours a day. Features: free public conference, free classified advertising, free laptop reference material, free newsletter, free downloads, product ordering, assistance, and more. Log on with any computer. Simple menus fit all 40 character, 8 line displays. Fast, interrupt drive, easy to use for beginners. Friendly. No online cost. Unlimited online time. PC Pursuitable! Optional online library access \$1 a month.

Program Collections

We have the largest "quality" collection of public domain, shareware and author-specific programs available for Model 100/102/200 users, i.e., text, print, telcom, business, graphics, drives, utilities, games, music, programming, education. Available online or mail order on disk. Listings available.

"Look to Club 100 for the largest selection of performance products to make you a laptop power user. Call today!"

Rick Hanson
Rick Hanson, Club 100

We're Always Adding Nifty New Stuff!
Call Today For Our FREE 1992 Catalog

(510)932-8856 voice • 937-5039 fax • 939-1246 bbs

CLUB 100 PO Box 436 Pleasant Hill, CA 94523-0436

Circle 165 on reader service card.

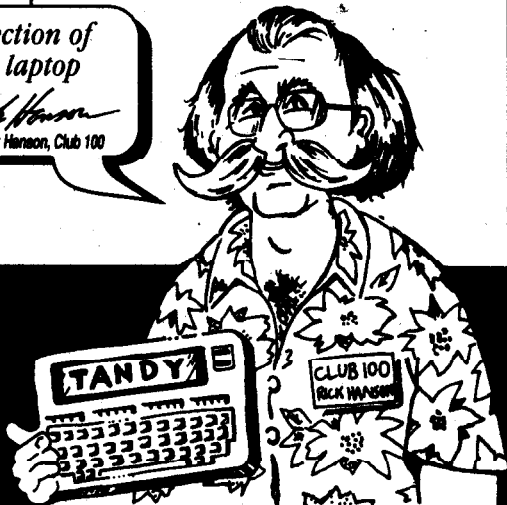

ON THE COVER:

This month's cover girl is the daughter of staff member Mary Fraser. Currently a student at the Granite State Ballet School, Joanna shows us one way to balance your books. You can follow her lead in balancing your books, but you can use your computer to help.

Photo by Bob Liddil

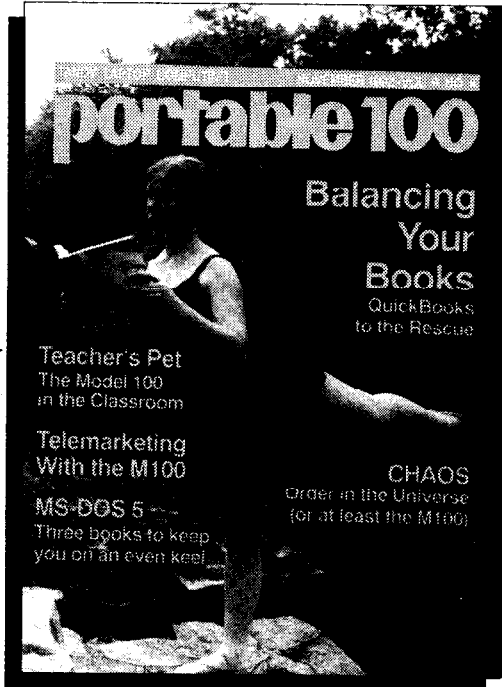

6 THREE WAYS TO EASIER MS-DOS 5
 ✓ MS-DOS
 M-102
 WP-2
 by Terry Kepner
These books fill the gaps in the MS-DOS 5 Manual.

7 QUICKBOOKS MAKES QUICK WORK
 ✓ MS-DOS
 M-102
 WP-2
 by Terry Kepner
Spend less time doing bookkeeping work.

13 TOY OR TECHNOLOGY
 ✓ MS-DOS
 M-102
 WP-2
 by Karen Robertson
The Tandy102 in the classroom.

14 THE MODEL 100--102 AND ME!
 ✓ MS-DOS
 M-102
 WP-2
 by H. Vance Orchard
The Model T in the News.

15 F10 -- THE MAGIC BUTTON
 ✓ MS-DOS
 M-102
 WP-2
 by Linda M. Tiernan
It's amazing what one key can do for you.

18 CHAOS -- DETERMINISTIC DISORDER
 ✓ MS-DOS
 M-102
 WP-2
 by William M. Lowerre, Jr.
Bringing order to disorder.

24 BROTHER, WHAT A PRINTER!
 ✓ MS-DOS
 M-102
 WP-2
 by Marc Fraser
The new Brother HJ100i from Brother International.

29 CONTACT.100
 ✓ MS-DOS
 M-102
 WP-2
 by Clyde C. Price, Jr. and George McLin
Telemarketing for the Model 100.

30 VIVA 2400 POCKET MODEM
 ✓ MS-DOS
 M-102
 WP-2
 by Ken Cheung
A light-weight, pocket sized portable modem.

31 CONTAB.BA, PART II
 ✓ MS-DOS
 M-102
 WP-2
 by R. Jim Siebert
Temperature conversions, continued.

34 BETTER LETTERHEADS, PART IV
 ✓ MS-DOS
 M-102
 WP-2
 by Mike Nugent
Beyond lines and boxes.

DEPARTMENTS

ROM WITH A VIEW

UO

NEW PRODUCTS

PORTABLE 100 CLASSIFIEDS

ADVERTISERS' INDEX

Words to make you think.

Interesting stuff.

More neat stuff.

Software, hardware, wanted.

4

5

38

43

44

BACKUP ALL OF YOUR PC COMPATIBLES WITH ONE PORTABLE TAPE SYSTEM



- **160 Megabyte Capacity**
- **Backup At Over 6 Megabytes A Minute**
- **Save Backup Time Management Time and *Drastically Decrease Media Costs***
- **Reseller Inquiries Welcome**
- **Easy to Use "Windows-Based" Menu-Driven Interface Software**
- **Small, Portable and Lightweight**
- **NO MORE LOST DATA OR FLOPPY DISKS TO MANAGE**
- **NO ADD-IN CARDS NEEDED "Plug and Go" over the Parallel Printer Port**
- **30 Day Money Back Guarantee**



ONE FOR ALL™ MODEL #PT1

*Contact ADPI For
More Information*
**Analog & Digital
Peripherals Inc.**
PO Box 499
Troy, Ohio, 45373
513/339-2241
Fax: 513/339-0070

ROM WITH A VIEW

Oops, We Skipped A Couple of Months

You have noticed, I'm sure, that the cover date on this issue is November 1992, yet the last issue you received was the July/August issue. What happened? Why no September or October? Well, unfortunately, we ran into a problem with our printer and the September issue was delayed.

We could have run the September issue as soon as the problem was cleared, but that would have meant mailing it in October, and having to try to play catch-up. And, of course, every time we have tried that in the past, we ended up just skipping the missing months. This time we decided to save the wasted effort and just skip the months outright. Hence, this November issue.

Don't worry about your subscriptions, those are being automatically updated by adding two months to the expiration dates. Everyone will receive the proper number of issues for their subscriptions (we go by number of issues, not the actual dates of the issues). You will see this change appear on your December mailing label. And speaking of December . . .

Portable 100 Transforms!

Welcome to the last issue of *Portable 100*! Next month, in its place, debuts a newspaper-style tabloid-sized publication — *Portable News*.

Now, before you all panic, let me say straight out that **the content of *Portable News* will be the same as *Portable 100***. I repeat, **the content of *Portable News* will be the same as *Portable 100***. We will still cover the Tandy portable computer series, both the proprietary Model 100/102/200, and the MS-DOS-style portables. You will still receive program listings, the BBS is still running, back issues will be available as long as the supply lasts (but look forward to a special package deal for them all), and all those great articles on how to use your computer. In addition, reviews of software, hardware and books, new product releases, and hints and tips from readers will be printed as fast as we get them.

"Why the size and format change," you ask, "if everything else remains the same?" Money. For the same cost to print 10,000 issues of *Portable 100*, we can print 30,000 issues of *Portable News*. This higher circulation makes it much easier for us to get and keep advertisers. That, in turn, pays the bills.

We've already started to see a change in the advertisers. Those loyal ones who have stayed with us all these years have responded with, "Anything that ups the circulation is fine with us." Several even increased the size of their ads. And, advertisers who used to hang up when we called are now asking for advertising rates. Several have even taken out advertisements in the new publication!

Another advantage to the new format is speed. *Portable 100* used to take two weeks for the printer to process. That includes shooting negatives, stripping, printing, cuttings, folding, stapling, and trimming. Most of the time was spent waiting for the folding, stapling, and printing. The binding process runs at about one thousand copies per hour while the press runs at ten thousand copies per hour. And the binding machine always has a waiting list of jobs stacked in front of it.

Portable News, on the other hand, will take only two days: We drop it off on Monday and pick it up on Wednesday. This means a shorter time to deadline and faster response on new products and news.

We hope you will like *Portable News* and look forward to hearing from you what you think of our first issue. Your suggestions and comments will be carefully examined and discussed.

tk

Toolbox

Manuscripts were typed into Microsoft Word 4.0 on a Tandy 1400 HD, where they were edited, spell-checked, and had basic format instructions inserted. From there they were loaded into a Tandy 4000 (80386 CPU, Tandy EGA Monitor, Tandy LP-1000 LaserPrinter) desktop computer and placed into Aldus' IBM PageMaker 3.01. Once there, design decisions on photo, figure, and listing sizes and placements were made. Here, pull quotes are placed, headlines, intros, and bylines are sized and positioned, and advertisements positioned.

Normally, the Tandy LP-1000 is capable of emulating only a Hewlett Packard Laser Printer Plus, but with the

addition of the Destiny Technology Corporation (300 Montague Expressway, Suite 150, Milpitas, CA 95035, (408) 262-9400) PageStyler 4.5MB kit, the LP-1000 is turned into a fully-compatible PostScript printer, with all 35 native fonts that are found in the Apple LaserWriter Plus printer. The Destiny PageStyler is available through the Tandy Express Order Hardware system.

Page previews were output from the Laserprinter. When everyone was satisfied with the appearance, final pages were output and artwork and line art ads were positioned. The finished magazine was then delivered to the printer, who printed it, labeled it, and mailed it to you.

TERRY KEPNER'S

portable 100

PRESIDENT/PUBLISHER
Terry Kepner

EDITORS
Terry Kepner, Mary Fraser
David Klein, David Sprague

NEW PRODUCTS EDITOR
Linda Tiernan

CONTRIBUTING EDITORS
Barbara Schwartz, Paul Globman
Mike Nugent, Stan Wong,
Tony Anderson
Gene Wilburn

CIRCULATION
Bob Liddil

ADVERTISING DIRECTOR
Bob Liddil

ADVERTISING ASSISTANT
Pauline Halvonik

BULLETIN BOARD SYOP
Chris Courson

**Portable Computing
International Corporation**
145 Grove St. Ext., #21, PO Box 428
Peterborough, NH 03458-0428
Tel: 603-924-9455 Fax: 603-924-9441



The Portable 100 Bulletin Board
603-924-9770
(300/1200/2400—8, None, 1)

Portable 100 (ISSN 0888-0131) is published by Portable Computing International Corporation, 145 Grove Street Ext., P.O. Box 428, Peterborough, NH 03458-0428. *Portable 100* is an independent journal not connected with any hardware, software, or peripheral equipment manufacturer. *Portable 100* is published monthly, except for a combined July/August issue in the summer. Entire contents Copyright © 1992 by Portable Computing International Corporation. All Rights Reserved. No part of this publication may be reproduced without written permission from the publisher. Portable Computing International Corporation makes every effort to assure the accuracy of articles published in *Portable 100*, but assumes no responsibility for damages due to errors or omissions. Subscription Service: All subscription correspondence should be addressed to *Portable 100*, Portable Computing International Corporation, 145 Grove Street Ext. P.O. Box 428, Peterborough, NH 03458-0428. U.S. subscription rates: \$19.95, one year; \$34.95 two years. Canada and Mexico: US\$24.95, one year; US\$44.95 two years. All other foreign (surface mail): US\$39.95, one year; US\$74.95 two years. Foreign Air Mail, add US\$50 per subscription year. All payment, except Canada, U.S. funds drawn on U.S. Bank. Second-class postage paid at Peterborough, NH 03458, and at additional mailing offices.

POSTMASTER: Send address changes to: *Portable 100*, Portable Computing International Corporation, 145 Grove Street Ext., PO Box 428, Peterborough, NH 03458-0428.

Used Computers And Technology

Ed Juge, Senior Director of Marketing Relations for Radio Shack, answers some common questions:

Why doesn't Radio Shack or Tandy initiate a trade-in program?

First, Radio Shack has never accepted trade-ins on any of its products. Our business isn't structured to be able to do that. We and others have from time to time run promotions where we accepted trades on one computers "in any condition," allowing about \$100 on them if you traded on an upscale new model.

Frankly, you can sell almost any working PC in the classifieds ads of your local paper for several times that amount. It just wasn't an attractive offer, or a very popular one.

Trade-ins, in most fields, require that the dealer wither 1) pad his new price or 2) give you a very low trade. At the current price of new PCs — ours and

others — you aren't likely to get any trades at all. Prices have never been lower, and neither have profit margins. While it would be a great PR move, and welcomed by everyone who ever wanted to trade up, it's just not economically possible.

Why do you change models so often? I can't keep up!

It's not us. . . it's technology. Our strategy does call for keeping us with the latest changes as technology and pricing permit.

It would be far more economical (and profitable) for use to "lock in" a product for a year or two. But, we can't do that and bring you the latest in technology, or the benefit of price reductions as they come available for us.

Unfortunately, change is a fact of life in this industry.

Ed Juge
Tandy/Radio Shack

Several readers have complained to me about how the "new" computer they bought last year is now obsolete, or that the price has dropped by fifty percent in the last six months. While I can sympathize with their plight, it's not fair to blame Radio Shack. The same thing has happened to Compaq, IBM, Dell and others. They all march to the tune of competition. If Tandy didn't introduce new and better models while dropping the price of current items to match competitors, they would quickly lose all their customers.

The only solution is to buy today what you can afford and know that twelve months from now something better will be along. either that, or never buy a computer because you're afraid it will become obsolete before you finish paying for it.

Back in 1977, you spent \$1,000 and got a 16K RAM computer with a keyboard and black-and-white monitor. Look what that buys you today!

-tk

New Price Reductions!

USED TANDY LAPTOPS!

Tandy 1500 HD 20 meg	\$ 795.00
Tandy 1400 HD 20MEG	\$ 695.00
Tandy 1400 LT — 2 dr.	\$ 395.00
Tandy 1100 FD - 1DR.	\$ 395.00
Model 100 — 24K	\$ 195.00
MODEL 102 — 32K	\$ 255.00
MODEL 200	\$ 325.00
TANDY WP-2	\$ 165.00
NEC 8201 - 16K	\$ 85.00
NEC MULTISPEED - 2 DR	\$ 295.00
PORTABLE DISK DRIVE I 100K	\$ 95.00
PORTABLE DISK DRIVE II 200K	\$ 125.00
TANDY DMP 105 OR 106	\$ 55.00
TANDY TRP 100 THRM PORT. PTR.	\$ 65.00
DICONIX INK JET PORT. PTR.	\$ 95.00
BROTHER HR-5 THERMAL	\$ 45.00
TTX THERMAL PORTABLE	\$ 75.00
128K & 256K MEMORY FOR 102	\$ CALL
MEM. SOFT, MODEMS & BOOKS	\$ CALL

**We Buy & Sell MD 4's - 6000's
1000, 2000's, 3000's, & 4000's**

503 236-2949

Pacific Computer Exchange
1031 S.E. Mill St. Suite # B,
Portland, OR 97214

THE ONE SOURCE FOR USED
TANDY EQUIPMENT

Circle 45 on reader service card.

**USED NEC LAPTOP SALE
HUGE SAVINGS ON THIS PACKAGE DEAL!!!**

The package includes: NEC 8201 laptop personal computer, 16K Memory, A/C adapter, printer cable & Tandy DMP-105 9-pin printer with tractor feed and ribbon.

UNBELIEVABLE SALE PRICE ON THIS COMPLETE PACKAGE. \$99 plus shipping

Built-in software includes: Word processor, Microsoft TM's N82-BASIC programming language, & telecommunications

Almost identical to a Model 100!

- Great for students
- Writers
- People on to go
- Just for fun, too!

Manuals not included

(503) 236-2949

Quantities limited, don't delay

Pacific Computer Exchange
1031 S.E. Mill St. Suite # B,
Portland, OR 97214

We accept Visa, Mastercard, prepay, or C.O.D. for cash.

Circle 172 on reader service card.

Wanted

Tandy Model 102's



in new or near New Condition.

NOW OVERSTOCKED!

GeoKon Inc.
48 Spencer St
Lebanon, NH 03766
603-448-1562 Voice
603-448-3216 Fax

Circle 35 on reader service card.

COMPATIBILITY: MS-DOS computers.

Three Ways To Easier MS-DOS 5

Three books trying to help you live with DOS.

by Terry Kepner

Learning MS-DOS 5 is not an easy. The manual is more than a little bit intimidating, and while it does start off with instructions for the novice, the information is overwhelming.

These three books try to fill the gap between what you need to know and what the MS-DOS manual explains, but the books are very different in approach. As an example of these differences I will use a problem I ran into several weeks ago. I wanted to send a printout of my display to my printer. It wasn't anything fancy, just the opening menu of a program. The screen-print key, marked on the computer's keyboard as `PRTSCR`, will only send the standard keyboard characters to your printer. To get the graphics characters requires a special printer driver in MS-DOS that you must load into memory first, specifying the appropriate printer information when you do so.

10 MINUTE GUIDE TO MS-DOS 5

This book takes a bit more than ten minutes to read. Actually, the ten minutes in the title refers to each chapter and it is definitely designed for the novice who wants to learn MS-DOS for regular use. It assumes more familiarity with computers than either of the two books reviewed last issue.

Unfortunately, the book focuses exclusively on the `DOSSHELL` program. While this program is much easier to use than MS-DOS directly, there are many things that you must go to DOS to do them.

The book begins with starting and running the DOS Shell program, using either the keyboard or a mouse (it is much easier to use with a mouse, but one isn't required). The next three chapters deal with using the DOS Shell program and disk basics. Following these are chapters on formatting a disk, specifying format parameters, displaying disk information, creating directories, removing a directory, working with files and file listings, organizing file listings, copying and renaming files, moving files, searching for files with similar names, deleting and undeleting files, viewing and changing the contents of a file, creating pro-

gram groups, running multiple programs in the DOS Shell, backing up a hard disk, and a final chapter (ten pages) on doing all of the above from the DOS prompt.

If you read this book cover to cover, using their examples, you will be able to use MS-DOS 5 from the shell program quickly and efficiently. On the down side, you will not know anything about the other MS-DOS programs and utilities.

Now, back to my example. 10 Minute Guide to MS-DOS 5 does not even mention printing of any kind. For that information, you must refer to the MS-DOS 5 manual.

PC LEARNING LABS TEACHES DOS 5

This book is not only bigger and has more pages, it includes a practice disk with a hundred files on it. Thus, as you go through the various lessons, the disk, a 5.25-inch one, provides a play area where you need not fear making mistakes.

The book covers both the DOS prompt commands and DOS Shell operations in thirteen chapters. The first chapter is an overview of DOS and gets you started. Chapter two covers the DOS filing system: subdirectories, changing disks, and formatting disks. Chapter three goes into running programs, copying, renaming, moving, deleting, and undeleting files, and removing directories. Common Command-line errors are also discussed. Chapter four goes into using wildcard symbols for multiple file selection and manipulation, using `DOSKEY` to recall and edit commands, and the `DOS HELP` utility. Chapter five covers changing the destination or order of data being generated (piping, redirection, and sorting), backing up files using `COPY`, `XCOPY`, `DISKCOPY`, `BACKUP`, and `RESTORE`.

Chapters six, seven, and eight cover the DOS Shell program (manipulating files, directories, and disks, essentially the same information the other books cover on the DOS Shell program).

Chapters ten, eleven, twelve, and thirteen cover the advanced topics of memory management; virtual memory; Terminate-and-Stay-

Resident programs; file attributes; editing ASCII text files; the `FIND`, `FC`, `CHKDSK` utilities, and `SMARTDRV.SYS`; and working with batch files.

PC Learning Labs Teaches DOS 5 does give information on printing files, but restricts itself to printing from the `EDIT` program and as printing applies to redirecting output. Nothing that was of help to me.

Continued on page 12.

PRODUCT SPECIFICATIONS & SUPPLIERS

10 Minute Guide to MS-DOS 5 — \$9.95

by Jack Nimersheim, ISBN 0-672-22807-6

Softbound 5.5-inch by 8.4-inch book, 148 pages.

Sams

11711 North College
Carmel, IN 46032

PC Learning Labs Teaches DOS 5 — \$22.95

by PC Learning Labs Staff, ISBN 1-56276-042-4

Softbound 7.25-inch by 9-inch book, 346 pages, includes one 5.25-inch disk.

Ziff-Davis Press

5903 Christie Avenue
Emeryville, CA 94608
(510) 601-2000
(510) 601-2099 — FAX

PC World DOS 5 Complete Handbook — \$29.95

by John Socha and Clint Hicks, ISBN 1-878058-13-4

Softbound 7.25-inch by 9.25-inch book, 588 pages, includes 3.25-inch disk.

IDG Books Worldwide
155 Bovet Road, Ste. 610
San Mateo, CA 94402
(415) 358-1250

COMPATIBILITY: MS-DOS computers.

QuickBooks Makes Quick Work

Bookkeeping is tedious work that steals precious time away from your business with pointless, complicated, and repetitive details . . . until now!

by Terry Kepner

I searched for ten years for a "computerized" bookkeeping system I could use for my various businesses. One after another, each system I experimented with either buried me with accounting tools I didn't understand, or required that I type in everything related to my business from day one before I could begin using them.

But not anymore.

They always seemed to start by asking me to type in my chart of accounts. Once I discovered what a chart of accounts was, as listing of the different expense and income areas of my business, I couldn't create one that would include every possible account I might ever need. Each time I made a chart and typed it in, I always discovered something later that I had left out, forcing me to start over. Then there was the problem of entering all that back data. No way was I going to type in everything from January to September before I could start using the system in October. By the time I finished, it would be December. Not to mention the problem of being unable to run the business because I was too busy playing with the financial records.

But not anymore.

QUICKBOOKS TO THE RESCUE

QuickBooks won my heart with the first few pages. It suggested that, because my main concern in business was with day to day bookkeeping, I simply start using the system immediately, putting in received payments and written checks as they occurred. While the first end-of-month report would not be cor-

A ♦ means the field has an associated list from which you can select. The payee field has a payee list that includes customers, vendors, and employees. Or you can just type a payee's name.

The check face is this top part of the check.

The voucher area is this bottom part of the check. If you have a monitor that can display more lines on the screen, you can customize QuickBooks so you see more lines in this area. See "43 line register/reports" on page 419.

QuickBooks displays the name of the account you're using.

The menu bar at the top of the screen lists menu titles and function keys to press to display the menu. Choose from the pulldown menu the same way you choose from any other menu.

Checking
Esc-Leave Ctrl-Record

Checks to Print: \$ 4,871.99
Current Balance: \$289,629.39
Ending Balance: \$285,557.48

The Checks to Print balance tells you the current total for checks you've written and not yet printed.

Current Balance appears if you have postdated transactions. It's the balance of all transactions through today.

QuickBooks calculates your new ending balance every time you record a check, based on all transactions that have been entered.

Figure 1. The check entry screen. Notice all the details provided.

rect, the next month all the outstanding receivables and my checks would come in and the computer would have an accurate balance from that point forward.

If I wanted, I could add the previous months, at my leisure. Doing so would provide year-to-date accuracy, but was not really required. The answer to my time restricted schedule!

Next, it suggested that I load in, from their list of twenty-two samples, the chart of expense and income accounts that most closely matched my business.

These cover most businesses, from manufacturing and agriculture to consulting and retail. Adding more accounts and deleting unused accounts is easy, simple, and painless

GETTING STARTED

With that kind of friendly approach, I dove right in. Installation was a snap. I followed the easy instructions on the "For A Quick Start" card included in the package: Turn on the computer, put the disk in my drive, type *INSTALL*, answer

TANDY LIQUIDATION

TANDY MODEL 100 \$ 199

with 32K RAM & 160K BUBBLE MEMORY (Used)
160K Bubble Memory Expansion \$ 89
 For TANDY Model 100 or 102 Computer (Used)
 Mgr. Sight Sound includes Power Supply

DMP - 105 Printer (Used) \$ 59

Blue Cloth Carrying Case (New) \$ 29

Multiplan ROM SpreadSheet \$ 19

(Without Instruction Manual)

HUGE LIQUIDATION

TRS-DOS HARDWARE & SOFTWARE

**CALL - WRITE - FAX - Dial BBS
FOR LIQUIDATION LIST**

BEFORE IT IS TOO LATE



(214) 276-8072

P.O. Box 461782
 Garland, TX 75046-1782
 FAX & BBS (214) 272-7920

**TERMS: COD or Prepaid, No Credit Cards
Shipping Not Included - LIQUIDATION ITEMS SOLD AS IS**

Circle 154 on reader service card.

a few simple prompts, and that was it.

Immediately after installation, I started working. First came the demonstration. I highly recommend that you run the tutorials. They take about half an hour (if you are a slow reader), and are well worth the time. And not only do you get a guided tour of the program, but you can load a dummy company and experiment with the program. You can start training on the system without worrying about wasting time with mistakes that might require rekeying data you already entered.

Next, I selected my printer type from a list of around eighty. One of my printers was listed (the laserjet) while the other was not.

This led to the first of my problems, all of which I lay at the feet of the printer manufacturers. In a nutshell, my so-called IBM-compatible dot-matrix printer wasn't, and the emulation on the Tandy LP-1000 laserjet was clearly lacking. The dot-matrix was easiest to fix: I told it I had a generic printer that supported IBM graphic characters, and then typed in the control codes for compressed printing in the appropriate places. Technical support at Intuit was always pleasant, accurate, and quick to answer the phone.

The laserjet problem had no good solutions. The difficulty was that when

in HP Laserjet emulation, the lines printed for forms (invoices, statements, and so forth) were spaced out and looked like they were done on a typewriter. When I selected the dot-matrix emulation (DMP-2110) on the laserjet printer, it printed the lines perfectly (made the forms look like they came with the lines

Adding and deleting accounts is easy, simple, and painless.

preprinted), but skipped a page between every form printed. Printing 100 statements required 200 pieces of paper (I have seen this with other laser printers that pretend to be dot-matrix printers). Not very efficient of time (someone had to separate the papers), or paper.

After that, I needed to load the program with the important information about my company, like my checking

account number and related information. All I had to do was type in the ending balance from my last bank statement and enter the deposits and checks since then. I could immediately write checks (either by hand or have the computer do it), and generate invoices for my clients and customers.

The wonderful thing about *Quick-Books* is that it makes copious use of lists. Every spot where more than one response is possible (like payees for checks, billers for invoices, terms on statements, product descriptions, and so forth), a diamond character is displayed. Pressing CTRL L at any area where a diamond appears instantly brings that list up. The arrow keys let you scroll through the names/items displayed. For very long lists, pressing the first letter of the name/item will advance you to the position in the list where that letter begins appearing. Very convenient and fast.

Should the name or item you want not be on the list, pressing F7 lets you instantly add the new one. For clients and vendors, you add the entire address entry with contact names and phone numbers. Again, diamonds will display in the places where appropriate (like the name of the salesperson responsible for this client). Editing and deleting is just as

T-200 Enhancement

XOS (Cross bank Operating System) will enhance your Tandy 200 and allow the three banks to share programs and data. XOS will bring a new level of computer functionality at the MENU, from BASIC, TEXT, and TELCOM.

From the Tandy 200 MENU you will be able to enter memos, rename files, set alarms, display and run programs that are in other banks, and much more.

Cut TEXT from one bank and PASTE it to a file in another bank. Open a "window" while editing in bank #1, and view other files from bank #2. Disable "word wrap" while editing for another perspective of your TEXT file.

While on-line with TELCOM, display FILES and Bytes Free, enter and edit TEXT files, or jump to another RAM bank without losing the host computer connection.

BASIC programs can read/write to files in other banks. Jump to programs in other banks or bring the program into the current bank and run it.

XOS provides fundamental database entry and retrieval functions with user defined fields, prompts, and display parameters. A bargain at **\$24.95**

Node Datapac Users Replace your ROM!!

RAMDSK.CO will replace the Node ROM and allow you to use one of those other ROMs you've always wanted. Retain all of the Node menu functions, plus the ability to move, kill, and name Datapac files under program control. A MUST for Node Datapac owners who have other option ROMs. RAMDSK.CO is available for the M100/M102 and T200... only **\$24.95**

N-READ.CO will allow a BASIC program to read a TEXT file stored in the Datapac without moving the file into RAM. An absolute necessity for multi-file database projects where the datafiles are kept in the Datapac. N-READ.CO is only \$9.95 but is yours for \$5 when ordering RAMDSK.CO.

For Your Amusement...

A beguiling PUZZLE/GAME program for your Tandy 200. A logical challenge that will keep you busy for many hours. Only \$10.00 for PUZZLE #3. Order with XOS or RAMDSK.CO and I'll send three additional puzzle/game/maze programs for your Tandy 200, at NO EXTRA CHARGE.

Software shipped on PDD1 (100K) diskette. All prices include shipping. Send your order with check or M.O. to:

Paul Globman

9406 NW 48th St., Sunrise, FL 33351

Circle 121 on reader service card.

simple.

This instant list capability extends throughout the program, and in some sections, like payments you receive or checks you write, can be used to split the money disbursement among several accounts or projects. One check from an advertiser, for example, can be applied to several invoices. One check to a vendor can be spread across several separate bills.

In addition, QuickBooks can *memo-rize* transactions. This memorization, called via the *CTRL T* command, lets you automate repetitive entries. For example, in payroll you have several split deductions for each check you write, which vary depending on the different plans you offer to your employees. QuickBooks can memorize a template check that has all the categories filled in for you, but the amounts are left blank. When you need to write a payroll check, use *CTRL T* to prepare the proper categories, then simply fill in the amounts.

You never have to worry about forgetting a category, nor making an addition mistake. QuickBooks takes the amount of the check and keeps a running total as you make your entries. At the end of the categories, everything should balance. If it doesn't, QuickBooks won't let you leave until you correct the wrongly typed entry.

It's not perfect, it won't catch a mistake that balances (say you accidentally make the deductions for a single-withholding instead of married), but it does eliminate the simple addition errors. This checking of split charges and payments extends to invoices and checks both received and generated by QuickBooks.

USING QUICKBOOKS

The program starts with a nine-item list of areas and tasks: Checkbook, Invoicing/Receivables, Accounts Payable, Chart of accounts, Reports, Company lists, Set Up/Customize, Tutorials, and exit. Exit is rather obvious and the tutorials I've already mentioned.

Set Up/Customize is the area where you select which company's files you want to work with (you can have more than one company in QuickBooks without having to duplicate the program itself), the program options you want activated, and the printer settings. This is where you can set up passwords to restrict access and control who does what when you aren't in the office.

Company options include which type of invoice to use (Service, Professional, and Product — unfortunately, you can't customize the invoices); receive pay-

The number of printed check or handwritten check appears in this column.

Account appears next to the memo text when a transaction is not highlighted. (You can control what appears on this line. See "Show Memo/Account/Both in registers" on page 411.)

The C (Cleared) field shows transactions marked as cleared when you reconcile your account.

QuickBooks calculates your new balance each time you record a transaction.

Asterisks indicate checks you've written but not yet printed. The word SPLIT indicates that information appears in the voucher area of the check.

Any Memo text appears here on the second line of the transaction.

You enter new transactions at the bottom of the register.

The Account field moves to a third line when the transaction is highlighted. (This account is a balance sheet account because this check was prepared using Accounts Payable.)

If you have project tracking turned on, the Project field appears on the third line of a highlighted transaction.

Current Balance is the balance before postdated transactions.

Ending Balance includes any postdated transactions.

This double line appears when you have postdated. All transactions dated after today are shown below it.

DATE	NUM	*PAYEE	MEMO	*ACCOUNT	PAYMENT	C	DEPOSIT	BALANCE
2/16 1992	***** SPLIT	Kevin S. Harris	Semimonthly pay=Payroll:Gross		928 45			232,507 54
2/16 1992	***** SPLIT	Miriam Kelman	Semimonthly pay=Payroll:Gross		892 85			231,614 69
2/16 1992		Bay Gas And Electric	Util:Gas & elec		127 88			231,486 81
2/16 1992		Bay Telephone	Tel		355 76			231,131 05
END								
Checking								
Exp=Leave Ctrl+J Record								
							Current Balance:	\$231,131.05
							Ending Balance:	\$230,361.05

Figure 2. The check register screen. Notice that the highlighted item shows an extra line of detail and the two diamonds displaying there that indicate lists are available via the *CTRL L* command.

ments as open item or balance forward; item codes on line items in invoices; days between date of invoice and due date of payment; sales tax payments as monthly, quarterly, or annually; project tracking (we use this for the different issues we publish), details printed on

You never have to worry about forgetting a category, nor making an addition mistake.

checks (message line, check dates as printed date, full detail on voucher checks); Show memo/account fields in registers; levels show in sub-accounts; and warn if check/invoice numbers are reused.

Program options include date format (month/day/year or day/month/

year), beep when recording data, Quicktrainer status, days in advance to remind you of scheduled bills and invoices, forty-three line display, start checks/invoices on screen at either date or payee/customer line, mouse speed, and warn to deposit received payments.

The Quicktrainer is an optional automatic help file that displays after ten seconds or twenty seconds of no typing when you move to a new screen. At first, this is helpful, but after you've used the program for a while it becomes annoying.

QuickBooks does not make assumptions about where you want the money placed when a customer pays an invoice. So, when you exit the receive payments routine receivables, you can have the program automatically warn you if you have not yet told the program where to credit the money.

QuickBooks has provisions for only two printers in its set up area. I am not sure if this limitation a problem. It isn't for my business.

Printer installation is easy, you just select your printer from the list provided. If you don't see your printer expressly listed, pick one that your printer emulates (like the Epson FX or IBM Compatible). In a worst case situation, you can choose one of the several Generic Printers. Each printer has four styles, with a complete selection of ports available (LPT1, LPT2, and all four COM

GOOD MEMORIES

We still make 'em . . . since 1983

Model 100 8K module \$29

NEC 8201 8K module \$29

Tandy 200 24K module \$59

Tandy 600 96K module \$99

NEC 8201 128K cartridge \$159

NEW SUPER SMALL DESIGN

w/4 banks of 32K RAM.

WP-2 RAM expansion \$CALL

Purple Computing

2048 Southside Rd.

Murphy, OR 97533

1-800-732-5012

Visa and MasterCard accepted.

Circle 55 on reader service card.

40Megs For Your Laptop

NOW ONLY \$345!

THE QUICKBRICK ...

connects directly to the expansion bus on your T1000SE, T1100, 1400LT, or Convertible for the best performance.

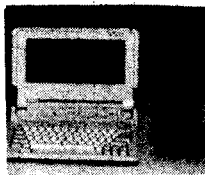

Need more than 40MB? Our portable QuarterPounder offers up to 530MB off the printer port. Low Prices! Or get a second QB40 drive for only \$225 while supplies lasts.

Systems Peripherals Consultants

7950 Silverton Ave., #107

San Diego, CA 92126

619/693-8611

Circle 20 on reader service card.

Ultra-thin Gender Changers!

Compatible connections in half the space! Drawing is ACTUAL SIZE!

25 pin Gender Changer F/F

9-pin M/M or F/F \$12.00ea

25-pin M/M or F/F \$15.00ea

Portable 100—Hardware

P.O. Box 428, 145 Grove St. Ext.

Peterborough, NH 03458-0428

(603) 924-9455

Visa, MasterCard, Amex accepted.
Please allow 6-8 weeks for delivery

Circle 117 on reader service card.

ports). The styles supported are check style (for preprinted checks), invoice style, report style one and report style two). All the report styles can be customized with specific fonts supported by your printer, and special control codes to implement things like italic and compressed printing.

My printer problem, as I mentioned, was with my printer and not with the printers listed. Once I figured out the correct control codes (from my printer manual), the printers worked correctly. Unfortunately, the laserprinter still skips a page when emulating a Tandy DMP-2110 and prints horizontal lines as dashes instead of lines when in Laser Jet Plus mode.

CHECKBOOK

Checkbook is where you generate checks for printing on your printer. The screen is similar to your actual checks, including a voucher area where you can detail disbursements. (see figure one). Associated with the check itself is the check register. Again, it looks remarkably like a real check register. (see figure two). If you handwrite your checks, this is where you will spend most of your time. Just use the arrow keys to maneuver to the bottom entry and fill it in.

The word split in NUM column means that the check is paying multiple invoices, or that deductions were made other accounts. This is also where you make direct deposits (not, though, paid invoices).

Changing, deleting, voiding, or reversing transactions is a matter of just selecting the transaction and going to work. Even I can manage to do it.

Reconciling the checkbook is so easy it defies adequate description. The program lists the outstanding deposits and

Service invoice

Printing view

For the service invoice, the printing view omits the Item Code field. However, you can press F8 to see this field and enter data.

Page 231 shows the detail view of a Service invoice.

Invoice Number *****		Date: 1/ 6/92	
Bill To		PB Num *Terms *Project <input type="text"/> <input type="text"/> <input type="text"/>	
Qty	(*)	Description	Rate Amount
			TOTAL \$ 0.00
			BALANCE \$ 0.00
Esc-Cancel Shift+ Next section F8>Show Item Detail Ctrl+ Record			

Professional invoice

Printing view

For the professional invoice, the printing view omits the Terms, Project, Item Code, Quantity, and Rate fields. However, you can press F8 to see these fields and enter data.

The ♦ here means you can press Ctrl-L in the Description field to enter an item code even in the printing view.

Invoice Number *****		Date: 1/ 6/92	
Bill To			
(*)	Description	Amount	
			TOTAL \$ 0.00
			BALANCE \$ 0.00
Esc-Cancel Shift+ Next section F8>Show Item Detail Ctrl+ Record			

Product invoice

Detail view

The product invoice header includes fields relevant only to product sales, such as Ship To, Ship, Via, and FOB.

The line item area includes Qty, Item Code, Description, Price Each, and Amount.

Invoice Number *****		Date: 1/ 6/92	
Bill To		Ship To	
PB Num	*Terms	*Ship	*Via
		1/ 6/92	
F8	Project		
Qty	*Item Code	Description...	Price Each Amount
			TOTAL \$ 0.00
			BALANCE \$ 0.00
Esc-Cancel Shift+ Next section F8>Show Item Detail Ctrl+ Record			

Figure 3. The three types of invoices. You can print on preprinted forms or have QuickBooks draw in the lines so you can use letterhead or blank paper.

QuickBooks calculates Existing credits, Total to apply, and Unapplied.

The list of invoices scrolls as you move the highlight to reveal more invoices than can be displayed at one time.

RECEIVE PAYMENTS			
Customer: Uh1, Letterell & Sone		Amount rec'd:	954.45
Date rec'd: 2/14/92		Existing Credits	325.00
Pat Method: Check		Total to Apply	1,279.45
Pat number: 2884			
Invoice	Due Date	Balance	Payment
0001000	2/13/92	65.00	0.00
0001001	2/10/92	1,214.45	0.00
TOTALS		1,279.45	0.00
Unapplied (to Credit Memo)			1,279.45
Esc-Cancel F8-Apply Discount F9-Paid in Full/Unpaid Ctrl+ Done			

F8 and F9 work only when the cursor is on an invoice line in the Payment column.

F8-Apply Discount displays a window where you can indicate an appropriate discount. The cursor must be on an invoice line in the Payment column.

With the cursor on an invoice line, press F9 to apply the payment in full to the invoice. Press F9 again to set back to unpaid.

Figure 4. Receiving payments always displays the outstanding invoices.

checks, you supply the ending balance and any service charges listed on the bank statement. Then you just check off the items listed as returned. When you finish, everything should balance.

Last month, when I did this, I discovered that my bank had charged me \$52.53 for new checks instead of the \$29.75 they had quoted me: Changing the checkbook entry to reflect the new amount was a matter of seconds. Never before have I balanced the businesses checkbook in under fifteen minutes. I was tickled pink. Especially because the statement from the bank indicated the check charge as a miscellaneous debit and ordinarily I would have wasted an hour or two trying to find that errant \$22.78. (And, boy howdy, did I ever give the bank a blast about charging more than they had told me).

INVOICING/RECEIVABLES

You can have any one of three invoice styles: Service, Professional, and Product (see figure three). Unfortunately, these forms cannot be customized in any fashion. What you see is all you can get.

Just fill in the invoice information, using **CTR L** in the areas that have the diamond displayed to select from a list of possibilities. When you finish, press **CTRL ENTER** to record the invoice. After all the invoices are entered, you print the invoices and the invoice numbers are automatically filled in by QuickBooks, based on your last previously printed invoice.

Naturally, you can also print statements that summarize your customer's invoices and payments, with multiple copies and selection criteria available.

Once the invoices are mailed, you need to make payments on them, using the screen shown in figure four. After telling QuickBooks the customer's name,

it displays all the outstanding invoices. You can selectively apply the payment to the invoices you want, including spreading the payment across several (even if it doesn't pay off any of them completely).

Next, when you need to examine the payments and invoices, you use the invoice register, which displays them in date order: It looks similar to the check register, except the column headers are date, number, customer, dues date, billings, and receipts.

Finally, you can make the deposit, which I described earlier. Deposits and checks make extensive use of your chart

**Simple enough
and easy enough
so that even I have
managed to use it
correctly.**

of income and expense accounts. Using **CTRL L** to make the list available, scroll through the list until you reach the item that pertains to the deposit (advertising income, subscription income, ext cetera) or check (postage, office supplies, and so forth). This is simple enough and easy enough so that even I have managed to use it correctly. Once you delete items that you don't need (like sales tax—there is none in New Hampshire), the list shortens and becomes quite manageable.

I do have one problem with the pro-

gram in this area: it can't handle prepayments on an ongoing basis. As an example, some of our advertisers pay three months in advance. When the invoices are run, their accounts should be automatically debited and a running balance displayed. Instead, I must remember each month to look in my prepayments income account and apply any credits to the invoices after creating them. If I forget to do one, that customer accidentally gets billed for something he prepayed. Perhaps they will fix this in a future release.

ACCOUNTS PAYABLE

This area is where you list major creditors and vendors. I use it for UPS and our printer. As I receive their bills, I enter them in this register, making the notation as to the expense account each bill goes into (such as shipping for UPS and Printing for the printer).

When I want to send money to either of them, I go in here and make a payment, telling QuickBooks exactly how much money I want to place on each bill, and which checking account I want to draw the money from. QuickBooks updates the bills' entries accordingly — marking paid those that are paid in full — and makes an entry in the checkbook register that a check was written.

CHART OF ACCOUNTS/ COMPANY LISTS

This area lets you add, change, and delete the income and expense items you require for your business, and keeps the records straight on such things as Owner Equity, depreciation, loans/loan payments, current liabilities, long term liabilities, credit card accounts, transfers between accounts, assets, retained earnings, draws, and other stuff like that (including 1099's).

Your company is built on lists. List of employees, lists of products, lists of suppliers, lists of invoice terms, lists of projects, lists of customers, and perhaps more. This is where you can access all of these lists in one place, and make corrections to them as needed.

REPORTS

This is where a computerized accounting system shines. QuickBooks comes with a complete set of reports: Profit & Loss, Sales Report, Accounts Receivable aging report, collections report, Accounts Payable aging report, Sales tax report, 1099 report, cash flow forecast report, payroll report, budget report, itemized income/expense report, Project report, and generic summary and transaction reports.



PC-PDD

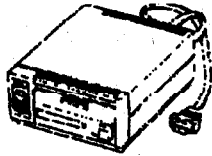

PC <---> Tandy Portable Disk Drive

Tandy WP-2 and Model 100/102/200 owners! Do you have an IBM PC or compatible? Are you tired of squirting your files through a null modem cable? Tired of setting communications parameters? Of turning your PC into a Portable Disk Drive (PDD) emulator?

PC-PDD is the first program which lets you attach your Tandy PDD to your PC and support the WP-2 and Models 100/102/200 as well as both PDD models (original 100K and the current 200K Model 2!)

- o Copy files to/from the PDD
- o Two bank support for PDD-2
- o Format, kill, rename files
- o "Point-and-shoot" interface & directory navigator
- o DOS file editor & browser
- o and much more!

PC-PDD requires an IBM PC or 100% compatible, 512K memory and a serial port. Send check or money order for \$49 + \$3 S&H (CA residents add 7.75%) or circle the reader service number below. A F-F gender adapter is required. Add \$7 if you need one.. Specify if your PC has a 25-pin or 9-pin port.



MicroMime
P.O. Box 28181
Santa Ana, CA 92799



CIS 70346,1267 Fax/Phone (714) 545-1765 MCI 200-3496

Circle 149 on reader service card.

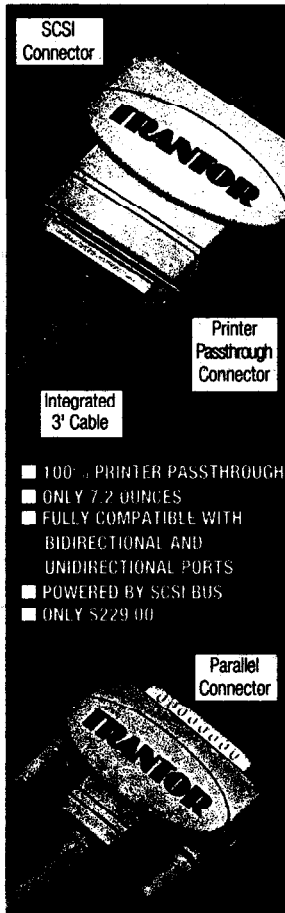

SCSI Connector

Printer Passthrough Connector

Integrated 3' Cable

- 100% PRINTER PASSTHROUGH
- ONLY 7.2 OUNCES
- FULLY COMPATIBLE WITH BIDIRECTIONAL AND UNIDIRECTIONAL PORTS
- POWERED BY SCSI BUS
- ONLY \$229.00

Parallel Connector

MiniSCSI^{plus}
HIGH PERFORMANCE
PARALLEL-TO-SCSI ADAPTER

Transform Your Parallel Port - Connect up to 7 SCSI devices to your parallel port and still use your printer!

Up to twice as fast as our original MiniSCSI, the MiniSCSI Plus lets you run a CD-ROM, tape drive, SCSI hard disk, SyQuest, Bernoulli or other SCSI device from almost any parallel port. For most notebook users, it's the only way to use SCSI CD-ROMs and tape drives. Plus, its integrated cable makes it a snap to move and share SCSI devices between desktops and notebooks.

Call For Details!
(800) 872-6867



Trantor Systems, Ltd.
5415 Randall Place
Fremont, CA 94538-3151
TEL: (510) 770-1400
FAX: (510) 770-9910

© 1992 Trantor Systems Ltd. MiniSCSI and MiniSCSI Plus are trademarks of Trantor Systems Ltd. All other product names are trademarks of their respective companies.

Circle 133 on reader service card.

These reports can be customized to set conditions and times. For example, you can make monthly, quarterly or annually customized reports for all of the above reports. Letting you create a set for your employees that requires no more than a few button pushes instead of filling dates to print report titles, row headings, and so forth each time you want a monthly profit/loss report.

Filters can be applied to restrict the reports to certain customers or requirements.

SUMMARY

I can't say enough good things about *QuickBooks*. It works quickly, it works efficiently, and it works well. I've tried to give a feeling for how the program works, and how easy it is use, but it's hard to compress 577+ pages of documentation and months of program use into a few pages.

All I can say is that it has greatly decreased the time I spend with finances, and gives me the information and reports I've always wanted but couldn't, or didn't, have the time to do.

The problems I have with the program (no prepayments, inability to add payees in check register) are small prices to pay for the ease of use and accurate

record keeping I now have.

For any small businessperson who isn't a financial wiz or professional bookkeeper, *QuickBooks* will make you life easier and let you devote more time and energy to actually running your business.

By the way, I use the program on a Tandy 1400HD, and they have worked flawlessly together (and the nice thing about a portable is should the power fail, I have plenty of time to exit the program without endangering my data).

PRODUCT SPECIFICATIONS & SUPPLIERS

QuickBooks — \$99.95

An accounting system for the MS-DOS computers, supplied on both 3.5-inch and 5.25-inch disks, with a comprehensive 577 page instruction book.

Intuit
P.O. Box 3014
Menlo Park, CA 94026
(415) 322-0573

Continued from page 6.

PC World DOS 5 Complete Handbook

This book comes with Norton Commander, a utility that rivals the DOS Shell program included with MS-DOS 5. In addition, it really is a complete reference to MS-DOS 5. Trying to list everything it covers would literally triple the size of this review.

While the book has a section for beginners, few beginners I know would be willing to buy a book this size, it is simply too intimidating in size and volume of information. It also has a chapter for experienced DOS users, detailing the differences between this version and previous versions. The instructions are clear and concise.

Not only did I find all the information I needed for printing graphics in this book, I also found several options listed that do not exist in MS-DOS 5! Specifically, the book says that the GRAPHICS command supports the /C, /F, and /pn options. It doesn't. Using them gets you an error warning.

SUMMARY

The handbook is the only one of the three books designed for random access from the index or table of contents. The other two are designed to be completely read.

If I were a beginner, I would get *PC Learning Labs Teaches DOS 5*, and once I had finished that, buy the *PC World DOS 5 Complete Handbook* for reference. While the handbook may have a few errors in facts, it provides so much else that that can be overlooked. □

COMPATIBILITY:

Tandy 102, WP-2.

Toy or Technology?



The Tandy 102 in the classroom.

by Karen Robertson

When I first saw the Tandy 102, I thought it was a child's toy. With twenty-five years as an elementary school teacher, I could think of a hundred creative ways laptop computers could motivate students to learn, toy or not. I could hardly wait to get the Tandys into my classroom, so I wrote a grant proposal for ten 102's, ten power adapters, ten sets of batteries, two battery chargers and an inexpensive printer. The grant was funded and for less than \$5000, I purchased a million dollars worth of educational value.

With ten laptops I could divide the class into groups of threes. Each group had their own computer. They named it and attached name tags to the computers and the carrying cases. A Battery Charging Monitor was selected in each group. Their job was to make sure batteries were charged every few days.

The computers, adapters, chargers and printers were all kept in a two-drawer file cabinet. The custodian weighted the bottom of the cabinet so it wouldn't tip over. He also attached rollers on the bottom and a handle on the top so it could be moved easily from classroom to classroom.

During class students could work collaboratively, inputting ideas as they were formulated. They wrote definitions, collected data and created stories. After school, one student in each group could check out the computer if his/her parent came to the classroom and signed a sheet. Brothers, sisters, Moms and Dads all took part in writing stories at home. Many parents had their first chance to use a computer, and their enthusiasm was evident upon return.

About the same time, I was contracted to teach an evening computer class for teachers for the University of California. I rolled the portable mini-lab into the media center. Each group of

three students was given one of the Tandy 102's. During the class the groups were asked to share reactions to videos and student presentations. They formulated their reactions and entered them into a file on the laptops. At the end of the evening, each computer was docked to the printer via a parallel cable and hard copies were produced. I took the printouts home and was able to evaluate the comments at my own convenience.

I was beginning to see that the Tandy 102 was no toy. The college students were just as motivated as the fourth graders. They, too, discovered that they were not restricted to what they could see on the liquid crystal display. With the SCROLL feature, they could add and edit ideas freely.

As a freelance writer, I began to see that the 102 could offer even more than motivation. I queried a national magazine with an idea for an article. It was a travel article on a resort in Nevada. The magazine responded affirmatively. I tucked a Tandy 102 in my suitcase and set off to the resort.

At the resort I interviewed the Public Relations director, with the featherweight computer on my lap. In the evenings, I turned my notes into fluid text. On the way home, my husband drove, and I produced my finished article. The hard copy was printed out and in the mail the first day home.

The Tandy 102 laptops, and my enthusiasm for them, was part of the reason Murrieta Valley Unified School District asked me to leave the classroom and become the District Technology Coordinator.

One of my computer friends developed a project using the Tandy 102's with his class. Students could check the computers out and take them home. As a partnership with parents, they wrote stories. By using the built-in modem,

they sent their stories to an Author Emeritus. He read and critiqued their stories and sent back his comments. Students improved their writing, keyboarding, word processing and telecommunication skills with parents taking an active part.

I have invested in my own Tandy Portable word processor WP-2. With the use of the WP Duet software, I can dump my stories and articles right into my Macintosh. There, it can be formatted, integrated with graphics and polished up as a completed manuscript.

Now I can sit in front of the TV, in the car, or anywhere else and work on articles as they come to me. The memory in the WP-2 holds about seventeen pages and that's more than most magazine articles require.

The Tandy 102 and the Tandy Portable Word Processor may look like toys, but they are both valuable technological tools. They allow the operator to work or create anywhere, any time.

Karen Robertson wrote a full page letter to the Murrieta School Board in 1986, telling them that she did not want a computer in her classroom. She told them computers were just a fad, a waste of money and that she was too old to learn something new.

When a writing colleague told her about all the editing capabilities of a computer, she went back to college to take a beginning computer course. In two weeks, she was hopelessly hooked on Technology. Within two years she had earned a certificate in Educational Technology, a certificate as Computer Resource Specialist, and was hired as District Technology Coordinator. She has taught computer courses for the University of California, and has been published in Electronic Educator, ComputerEdge and many other magazines.



The Model 100-102 and Me!

The Model T in the News.

by H. Vance Orchard



When I retired Dec. 31, 1983, after 32 years as a reporter for a daily newspaper, I was introduced to the TRS 80-Model 100.

It was to serve as my PC/word processor for two years as I continued to do a weekly column from home for the Walla Walla *Union-Bulletin*.

I continued to write a column until 1989 for the paper I had been employed by since 1951. Then, cut adrift due to a "change of format" by the paper's editors, I also lost the M100, loaned to me when I retired.

The M100, with its built-in modem and other goodies, was ideal for the purposes for which the *U-B* had purchased it—and for several others. The *U-B* found, as did many U.S. newspapers, that the M100 was a heckuva reporting tool! Sports writers took them to games away from home and got their stories into the office faster and with more dispatch.

Stringers for the paper, working from their homes and reporting on events of the communities peripheral to Walla Walla, used the M100, then "modem-ed" their stories to the Walla Walla newsroom.

Other reporters, such as those covering the courthouse, found the M100 an especially useful tool that dramatically changed their way of doing their job. These reporters simply typed into the M100 the mass of details on court cases, police reports, etc. Then, back at the office, they downloaded to the desktop PC or main system. Neat!

And, covering a trial in a distant city, then getting the story phoned in was no longer the tedious, time-consuming affair of the old telephone-and-rewrite days.

Now, with the handy-dandy M100 or T102, the story was written, or composed (except for some closing paragraphs), then sent by modem to the office.

Even at the near tortoise-like speed of 300 baud, the job was done in five or 10 minutes. This compares with 30 minutes to an hour—and often more!—on the telephone in the "good old days!"

When I had to give up the *U-B*'s M100, I turned to a desktop PC to continue my retirement career of freelance writer. But, I couldn't forsake the charm and utility of the M100. Besides, I needed one in my new, retirement volunteer job. I soon was unpacking a brand-new T102 and putting it in my brief case.

My volunteer chores each Wednesday consist of doing archive research at Whitman College's Penrose Memorial

I couldn't forsake the charm and utility of the M100

Library. Here, the T102 has proven a versatile tool for what I do there. And, its light weight sure has an appeal that no other laptop can boast. It fits in my brief case, leaving ample room for files and other material I work with. Using most of the laptops of today, I would have to pack two carrying cases to Whitman on Wednesdays!

At the library, a major assignment from my boss, the library's Northwest Section archivist, Lawrence L. Dodd, is to write the history of newspapering in Walla Walla County. Much of my research is in the old newspapers and magazines and books found in the ample

library. There are methods of transferring this information to my desktop PC but I do the chore real adequately and with ease with my T102!

The information is typed into the T102, then, when I go home, I download to the PC, using the good old "Transfer" software I got from Club 100 a few years back.

Gathering up the various pieces of information, now on my PC's hard drive, I then put the story (or chapter) together and add to the diskette which holds the current story or project on which I'm working for Dodd.

My T102 and I share other writing fun times as well as the Wednesday stint at Whitman College.

When I travel, I always toss the little PC into my luggage. Then, be it at Reno, Nevada, or Lincoln City, Oregon, I compose stories (or make notes for later composition) of what I am doing, seeing and the people from whom I am learning. I guess my having been a reporter for more than 50 years is a style not easily shed, even if I am retired.

And, I don't see how I can as long as I have my M102! Since leaving the daily newspaper field at the *U-B* after 38 years (32 on the staff and 6 when retired) I continued writing my column of general interest (people, places and things) for *The Times* of Waitsburg, Wash., a weekly newspaper.

While my stories are in the main composed on the desktop PC at home, and modem-ed at 2400 baud the 20 miles to *The Times*, I still use my T102. Often, the stories I do for Whitman College wind up being transferred from the T102 to *The Times*.

As do the stories written from a room over the casino action at Reno or from a motel overlooking the Pacific and its wave-pounding action on the nearby beach.

COMPATIBILITY:

Tandy MS-DOS portable computers.

F10 — the Magic Button

It's amazing what one key can do for you.

by Linda M. Tiernan

Having owned a Tandy computer with *DeskMate* for about a year now, I have come to appreciate the convenience of some of the unique *DeskMate* programs. This article, for instance, is written and proofread using *Text*. I cut and paste, merge and save, copy and center, search and replace, using this simple word processing program. *Text* also "strains through" the article, removing all non-ASCII characters, so I can send a "pure ASCII" file to the main editorial computers of *Portable 100 Magazine*—a timesaver for them and for me. I know I don't have to worry about incomprehensible, invisible control codes messing up my article. (The mistakes you see here are natural and organic.)

Likewise, the *Address* program, while it probably couldn't handle a business, responds well to my needs. It can find part of a name for me (text-searching) and print just the labels I need for my Christmas card list. It can even merge a selected list with form letters written in *Text* to let me write all my fellow E.C. alumni that I've changed addresses.

DeskMate's Calendar program (not to be confused with *Month*, the little desktop calendar you see occupying two spaces on the opening *Desktop* screen) allows you to log in appointments of the day and annual events of a particular day. You can also log in Reminders which will show up every day until you delete them. Your computer can even set off an appointment alarm, if you leave the power on.

Crisscrossing these programs—available from all of them at any time, giving access to "quickie versions" of the other programs—are the *DeskMate Accessories*. These are activated by pushing the *DeskMate Accessories* button, F10. The nine accessories available when you push this button are: Setup, Spell

Checker, Calculator, Phone List, Corkboard, Month, Alarm, To Do List, Clipboard, and Task Switch. Upon closer inspection, you will see that they look mighty familiar—most of them are integral parts of the regular *DeskMate* programs.

You have probably used Setup at least once in your life, more if you've changed printers or communication equipment or adjusted your computer for Daylight Savings Time. After choosing Setup, you have only one active function button, F2.

The program will remind you that you need to save the changes you have made.

From here you can choose your communications port, connection, modem type and dial timeout; the palette, permanency, and intensity of your display; to mouse or not to mouse, and how fast to click it; the proper date and time; which printer you'll be using (lots of IBM and Tandy choices, but you can choose to get a new list of printers from a floppy disk if you need it); and whether or how soon you wish the screen to blacken after a period of inactivity, to save your screen. In all of *DeskMate*, this is the only screen where you won't see F10 as an option . . . because you're in it.

To find *Spell Checker* at home, just go

to the *Text* program and hit F3(Edit)/Proof. But here in F10-Land, you can still call up any ".DOC" file on this drive to be proofread. In either *TEXT* or *SpellChecker*, you can add words to your own personal spellchecking dictionary, but in F10/*SpellChecker*, you can also edit or remove them. You can check a single word, too. In either case, the program will remind you that you need to save the changes you have made to the proofreading dictionary. (Note: Do not confuse the proofreading dictionary with the *Dictionary* program available separately from Radio Shack. The *Dictionary* program acts like a "real dictionary," definitions and all, and is activated in *TEXT* by using F4 (Text)/*Dictionary*.)

Calculator is one of the three *Accessories* which is not linked to another *DeskMate* program. It is exactly what it appears to be, a little mock-calculator in the middle of the screen. On the right is a little yellow "register tape." Like any calculator, it has Memory, Clear Entry, Clear All, and Cancel (ESC) buttons. It's handy for that quick calculation in the middle of your letter, or an estimate while using *Filer*. It accepts both * and X for multiplication.

The *Phone List* is drawn straight from your *Address* file. It looks like a mock steno book—name on the left, "W" or "H" phone on the right. You can print this phone list, dial automatically from it (if you have your modem connected, of course), and choose whether Work or Home phone numbers will be listed. It's a quick way to get your complete phone list printed to post on the wall, all in one fell swoop. No matter which list or sublist you have selected in *Address*, it is the full list which will be displayed in the F10 *Phone List*.

The *Corkboard* is a memo pad. It is the second *Accessory* not tied to a *Desk-*

USE YOUR DESKTOP COMPUTER AS A DISK DRIVE FOR YOUR M-100.

New
IBM, MS-DOS
version works
over the phone!

Disk+

on Snap-In™ ROM

NOW
AVAILABLE
ON
M-100

Try *Disk+* for 30 days. If you aren't as excited as we are, return it for a full refund.

When we designed *Disk+* we did it out of necessity. We wanted a way that we could just connect a Model 100 to our desktop computer with a cable and save files onto the desktop's disk drive. We wanted it to be so simple to use it would be self-explanatory.

Picture this. *Disk+* comes to you on a Snap-in ROM and a diskette for your desktop. You take a quarter and open the little compartment on the back of your Model 100. Then you just press the ROM into the socket. *Disk+* appears on your main menu just like a built-in.

You connect your Model 100 to your other computer using an RS232 cable (available from TMNE for only \$20).

You just place the *Disk+* diskette into the desktop's drive and turn on the computer. It powers up automatically and says "awaiting command" on your desktop's screen. Then you just put the widebar cursor on the Model 100 main menu on *Disk+* and press ENTER. You are shown your RAM files arranged just like the main menu.

To save a file to your other system's disk drive, you just move the widebar cursor to the file you want to save and press ENTER. It is saved instantly with no further action.

To look at the disk directory, you just press a function key on your Model 100. You see immediately the disk directory on your Model 100 screen, and it is arranged just like your Model 100's main menu.

To load a file from the diskette to your Model 100, you just move the widebar cursor to the file and press ENTER. The file is transferred to your Model 100's RAM instantly. You can press F8 and go back to the main menu, and the file you loaded from diskette is there, ready to use.

It is so nice to be able to keep your documents, programs (both BASIC and machine code) and *Lucid* spreadsheet files on the diskette, and bring them back when you need them. All files are ready to run or use with no changes or protocol by you.

If you have access to a desktop computer and don't have *Disk+*, then evidently we have done a poor job telling you about it.

All files and programs that you load or save, go over and come back exactly as they are supposed to be because of full error checking. This guaranteed integrity is really a comfort. *Disk+* is wonderful in so many other ways. For example, you can do a "save all" of all your RAM files with just a touch of a function key. That group of files is saved on the diskette under a single filename with a .SD (for subdirectory) extension. Any time you want, you can bring back all those files at once, or just one or two if you like, again with one-button ease.

Disk+ takes up no RAM. That's zero bytes either for storing the program or for operating overhead.

What really excites most *Disk+* users is text file cross compatibility. Your Model 100's text files are useable on your desktop computer, and your desktop's text files become Model 100 text files.

This means you can write something on your Model 100, and with *Disk+* transfer it

instantly to your desktop and start using it right away on your bigger computer. Or the way we like to work is to type in a document on the desktop computer and then transfer it to our Model 100 with *Disk+*. Then we print out the document, beautifully formatted, using WRITE ROM.

Disk+ works with just about every micro sold, from IBM PC and its clones, to all Radio Shack computers (yes, all), to Apple II, Kaypro, Epson and most CPM. Just ask us. More than likely, your computer is supported.

Incidentally, hundreds of Model 100 owners have gone to their Radio Shack stores and bought a color computer because it is so low priced, and with *Disk+* they have an inexpensive disk drive.

And if that weren't enough, how about this: *Disk+* also provides cross-compatibility between different computers like IBM, Apple or the Model 4 using the Model 100 as the intermediary device. Quite a feature!

The snap-in ROM is really great because you can use other ROMs like *Lucid* or WRITE ROM. They snap in and out as easily as an Atari game cartridge and you never lose your files in RAM.

Anyone who ever uses *Disk+* simply can't do without it. But so many times we have had new users call us and say, "Wow! I had no idea when I ordered it that *Disk+* would be so fantastic. I just couldn't believe that I could use my desktop computer's disk drive with my Model 100 just like it is another main menu."

That's why we sell *Disk+* on a thirty-day trial. If you aren't completely satisfied, return it within thirty days for a full refund. Priced at \$149.95 on Snap-in ROM. MasterCard, Visa or COD.

Distributed by:

Tri-Mike Network East

P.O. Box 372, Peterborough, NH 03158

Please add \$5.00
shipping and handling
charge to your order.

Circle 73 on reader service card.

Another fine product from the innovative people at PCSG!

Mate program Wherever you are, you can call up the **Corkboard** to jot down an idea before it gets away. If you cancel the **Corkboard** (Esc), the idea stays there. It won't vanish until you choose to Clear it. You can also print your **Corkboard** memo, on the spot, even though you're knee-deep in another program at the time. There's no excuse for letting those sudden bursts of inspiration get away.

Month is the little calendar that you normally see in the regular **Desktop** layout—not the (appointments) **Calendar** program. Use **Month** to answer quick questions of date determination: On what day of the week is New Year's Day next year? What's the first Monday in October? What day of the week is my birthday in the year 2000? Like the **Calculator**, **Month** is good for an on-the-spot estimation while you're in the middle of something else. Only five choices are used in **Month**: P for the past month, N for next month, Ctrl-P for this month, a year ago, Ctrl-N for this month, a year from now—and, of course, the Escape key to cancel.

Alarm is where you set the alarm to go off in BOTH this application AND the **Calendar** programs. If you don't turn on this alarm at this location, your **Calendar** program alarms will NOT go off! You can set a single reminder alarm for yourself at this location. When it goes off, it beeps, and logs a message that you can read by pressing F9, the **Message** function button. F9 flashes at the top of the screen until you press it. Then you choose the Alarm 1 (or "Alarm [whatever]") message to see what it is you were reminding yourself to do. Once you've read the message, F9 returns to normal, and the Quick Alarm Time is erased from F10/Alarm. You get just one beep, then a flashing F9 light, with this alarm function. Remember, you must leave your computer on for the alarms to go off! A turned-off computer is like an unplugged alarm clock... nothing happens.

The **To Do List** comes straight from the **Reminders** in the **Calendar** program. The **Reminders** are not attached to any particular day, and stay visible in **Calendar** until you remove them. The **To Do List** gives you an opportunity to review them, but not to edit or delete. For that, you must go to the **Calendar** program.

Clipboard is actually the paste buffer from **Text**. When you cut or copy text or pictures from **Text** or **Draw**, this is the place where that material is "set aside" for you to paste or copy somewhere else. You cannot view the **Clipboard's** contents, but from F10, you can save perma-

nently whatever you have stored in there, and see the filename listed on the mock clipboard. **Clipboard** works in any program that has an **Edit** button—it is the cut-and-paste receptacle for **DeskMate** applications—and it is never cleared until you clear it, either via a program's **Edit** functions or by direct file deletion using F10/**Clipboard**. Sometimes (or so I've read, although I have not tested it) even programs without **Edit** boxes can still make use of cut-and-paste functions (and therefore **Clipboard**).

The third accessory not related to another **DeskMate** program is **Task Switch**. Learning how to use **Task Switch** properly is one of my future projects. What this accessory allows you

If you don't turn on this alarm at this location, your Calendar program alarms will NOT go off!

to do is switch between programs, almost in such a fashion as to appear to be using them simultaneously. A very good example of how **Task Switch** is used is described in *DeskMate 3 Made Easy*, by Ramon Zamora and Bob Albrecht (Osborne McGraw-Hill, 1990, \$19.95). This example shows how to incorporate pictures made in **DeskMate Draw** with a memorandum written in **DeskMate Text**, and printing it out and saving it as a single item.

That brings us to the bottom of the F10 box and the bottom of my allotted space. Although I still recommend Michael Banks's *Getting the Most Out of DeskMate 3*. I understand that it's now out of print. Don't panic; the *DeskMate 3 Made Easy* book mentioned above is as full of helpful hints and tips.



he OWL..



"On-site Weather Logger", M100/T102-based outdoor & indoor environmental monitoring & control. Systems or a-la-carte.

OWL Analog/digital converter \$185.
7 inputs, 8 bits, 0->1.28 vdc.
5 outputs, poweroff, resume timer.

HOOT program ROM \$65.
Spreadsheet-ready data, or direct view.
Powerful remark and command entry.

NEMA gasketed case & backplane.

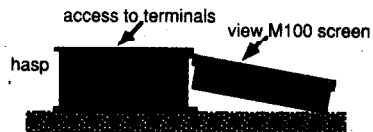

7 channel input multiplexer \$75.
32 channel output multiplexer \$95.
Up to 49 inputs in 7-channel "pods".

Fahrenheit temperature probe \$55.
Zero to 127, $\pm 0.3^\circ\text{F}$; sealed on a cable.
Our proprietary, rugged design.

Thermocouple multiplexer \$95.
Tiny probes, rapid response.
4 standard type T per OWL channel.

New solid state humidity probe \$225.
Zero to 94% RH, $\pm 3\%$. Our own design!
Latest switched capacitor technology.

Anemometer/vane/tachometer \$185.
Zero to 127 mph using Digital cups.
Tachometer available separately too.

Tipping bucket rain counter \$130.
Counts each 0.01 inch of rain.
Event counter available separately too.

Barometer/pressure sensor \$115.
Any 128 mb range for barometry.
Other absolute or diff. ranges, too.

Please circle reader service number 85



eme systems

voice: (510) 848-5725
fax: (510) 848-5748
2229 5th St., Berkeley, CA 94710

COMPATIBILITY: Tandy Model 100, 102, and 200 (untested).

CHAOS - Deterministic Disorder

Bringing order to disorder.

by William M. Lowerre, Jr.

Dynamical systems such as populations, the human heart, or a water wheel sometimes behave, or seemingly misbehave, in a chaotic manner. Chaos in such systems, sometimes called deterministic disorder, shows a sensitive dependence on initial conditions. Two of these programs demonstrate the chaos encountered when a dynamical systems process is described by a relatively simple equation from high school algebra or geometry. The third benefits from, but does not require, an understanding of imaginary numbers.

POPULATION GROWTH AS A DYNAMIC SYSTEM

In the first case, Listing 1, the equation in line 130, $Y=R*X*(1-X)$

**In real life, populations
sometimes behaved
erratically.**

X), where the * represents multiplication, forms a parabola when the values of Y are plotted for all possible values of X . It is sometimes called the *logistic difference equation*. The portion we are concerned with is in the first quadrant with the apex at

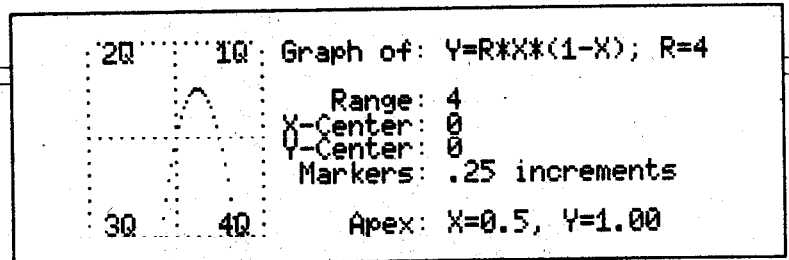

Figure 1. A normal plot of the logistic difference equation (Y VS X), as produced by the program in listing one.

$X=.5, Y=.25R$, and passing downward across the ordinate ($Y=0$) at both the origin, $X=0$, and at 1. (Figure 1 illustrates.) As surprising as it may seem, this equation has been used to describe population growth under a limiting constraint.

The earlier Malthusian population growth equation was of the form $Y=R*X$, where X equals population at the beginning of the reproduction period, Y equals population at the end of the reproduction period, and R equals the periodic reproduction rate, e.g. 1.2 creatures per creature per period. The equation represents a straight line through the origin when Y is plotted continuously for all values of X . However, when processed dynamically, where each value of X , except the first, equals the previous value of Y , a plot of Y versus number of periods or iterations, J , not versus X , shows Y to be exponential with respect to J , continuing to infinity. In banking, growth of initial principal, X , with interest compounding at rate R per period for J periods, may also be described by the same straight line equation when processed dynamically, i.e. treated as a dynamical system. You can satisfy yourself that this is so by temporarily substituting $Y=R*X$ for the parabola formula in line 130 of Listing 1, and then running the program, or by doing a couple of iterations manually. Make initial $X=\$1$ and $R=1.05$, for example.

The Club of Rome, and many population experts, noted that the number of fish in a pond does not increase to infinity, but is instead limited by food, oxygen, space, etc., and that when some upper limit is reached the population then stabilizes. Based on this sort of research, they proposed a revised equation, such that the population increases, but at a steadily decreasing rate, in accord with the parabolic

Run No	X-Midpoint	jY-Midpoint	Scale
1	0	0	1
2,3,4,5,6,7	-0.740625	0.150592	2,3,4,5,6,7

Table 1. Suggested Mandelbrot Experimental values to use with the program given in listing 3.

```

100 'LISTING 1 - CAOSPB P70 8/7/91 Copyr
ight 1991 by Wm. M. Lowerre Jr.
101 DEFINTJ,K,M:DIMY,J,K,X,R,M'DEFDBLR,X
,Y
102 PRINT"Plots the logistic difference
equation:":PRINT:PRINT"          Y=R*X*(1-X
).":PRINT:PRINT"      Equation is solved
dynamically.":PRINT" (i.e. iteratively
with X = Y Prior.):":PRINT" Solved static
ally it forms a parabola."
103 PRINT" (Tap any key to continue.)";
104 A$=INKEY$:IFA$=""THEN104
105 CLS:PRINT@1,;:INPUT"Initial 0=<X<1 =
";XI:X=XI:IFX<0ORX=>1THENCLS:GOTO105
106 PRINT@41,;:INPUT" Ratio 0=<R<4 = ";R
:IFR<0ORR=>4THENPRINT@59,"      ":GOTO106
108 J=0:M=0
110 CLS:PRINT@281,"XI=";XI;" R=";R;:IFM=
0THENY=X:GOTO131ELSE130
125 J=J+1
130 X=Y:Y=R*X*(1-X):IFINKEY$=CHR$(27)THE
N165
131 K=Y*64
132 IFK>63THENPRINT@21,"OFF SCALE!! M=";
M;:GOTO165ELSEIFY=<0THENPRINT@301,"CRASH
!!! M=";M;:GOTO165
150 PSET(J,63-K):M=M+1
151 IFJ=239THEN160
152 GOTO125
160 PRINT@1,"Xtend (y/n)?"
161 A$=INKEY$:IFA$=""THEN161
162 IFINSTR("Yy",A$)THENJ=0:GOTO110
165 PRINT@1,"RUN (y/n)? ";
166 A$=INKEY$:IFA$=""THEN166
167 IFINSTR("Nn",A$)THENMENUELSE105

```

End of listing.

Listing 1. This program plots a logistics difference equation solved dynamically.

equation defined above when processed dynamically (at least for some commonly encountered values, as we shall see). Many population experts agreed with this formulation.

In real life, populations sometimes behaved erratically, but this was presumed to be the result of random factors such as

If I had written this same program some years ago, I probably would have believed there was a bug in it.

weather, disease, etc. However, when this equation is treated dynamically, over a wide range of starting conditions, the explanation is seen to be deterministically contained within the dynamics of the process itself.

CRITICAL DEPENDENCE ON INITIAL CONDITIONS

Let's further pursue the population dynamics example. Many wild animals, with the notable exception of human beings, breed and propagate on an annual cycle, so values of J increment in years as integer units of time. Given a starting population, X , and a growth factor, R , the population at the end of the first year can be calculated or determined. Population Y at the end of the first year, then becomes the starting population X for the next or second year, and so on. Hand calculations are onerous, and until the computer made great calculating power available to investigators, the many repetitious calculations needed to identify the onslaught of chaos were beyond practicality. Now, with only a Model 100 it is easy to experiment and observe the long term results of various initial conditions on a dynamical system process.

Run Listing 1, inserting a non-negative value less than 1 for the initial value of X (XI), and a non-negative value less than 4 for R , and watch the population curve unfold. Each screen represents 240 periods (0 through 239), with a normalized vertical population scale of 1 (actually, the half open interval $\{X: 0=<X<1\}$). I suggest that, at least at first, you keep the initial value of X constant at 0.2, but vary the value of R , using values of 0.1, 1, 1.25, 2.4, 2.9, 3.2, 3.5, 3.565 and 3.8. Notice that as R increases from zero (0), the period ending population, Y :

- first decreases over time and appears to stabilize for many periods, finally crashing to zero at the end of $J=64$ periods

```

200 'LISTING 2 - CAOSIN P173 8/7/91 Copy
right 1991 by Wm. M. Lowerre Jr.
201 DEFINTJ,K,M:DIMY,J,K,X,R,M'DEFDBLR,X
,Y
202 PRINT"      Plots the equation:":PRINT:
PRINT"          Y=R*sin(2*Pi*X).":PRINT:PR
INT"      Equation is solved dynamically.
":PRINT" (i.e. iteratively with X = Y P
rior.):":PRINT" Solving continuously forms
a sine wave."
203 PRINT" (Tap any key to continue.)";
204 A$=INKEY$:IFA$=""THEN204
205 CLS:PRINT@1,;:INPUT"Initial 0=<X<1 =
";XI:X=XI:IFX<0ORX=>1THENCLS:GOTO205
206 PRINT@41,;:INPUT" Ratio 0=<R<1 = ";
R:IFR<0ORR=>1THENPRINT@61,"      ":GOTO206
208 J=0:M=0
210 CLS:PRINT@281,"XI=";XI;" R=";R;:IFM=
0THENY=X:GOTO231ELSE230
225 J=J+1
230 X=Y:Y=R*SIN(3.14159265*X):IFINKEY$=C
HR$(27)THEN265
231 K=Y*64
232 IFK>63THENPRINT@21,"OFF SCALE!! M=";
M;:GOTO265ELSEIFY=<0THENPRINT@301,"CRASH
!!! M=";M;:GOTO265
250 PSET(J,63-K):M=M+1
251 IFJ=239THEN260
252 GOTO225
260 PRINT@1,"Xtend (y/n)?"
261 A$=INKEY$:IFA$=""THEN261
262 IFINSTR("Yy",A$)THENJ=0:GOTO210
265 PRINT@1,"RUN (y/n)? ";
266 A$=INKEY$:IFA$=""THEN266
267 IFINSTR("Nn",A$)THENMENUELSE205

```

End of listing.

Listing 2. This program plots the sine equation, solved dynamically.

- (R=0.1);
- b. then decreases over time and appears to stabilize (R=1);
- c. then remains stable (R=1.25);
- d. then increases over time and appears to stabilize (R=2.4),
- e. then increases, oscillates, and stabilizes (R=2.9),
- f. then increases and oscillates between two values (R=3.2),
- g. increases and oscillates between four values (R=3.5),
- h. increases and oscillates between eight values (R=3.565),
- i. then varies chaotically as seen in Figure 2 (R=3.8).

The chaotic behavior in i. (R=3.8) is not random. It is calculable but not statistically predictable in terms of mathematical

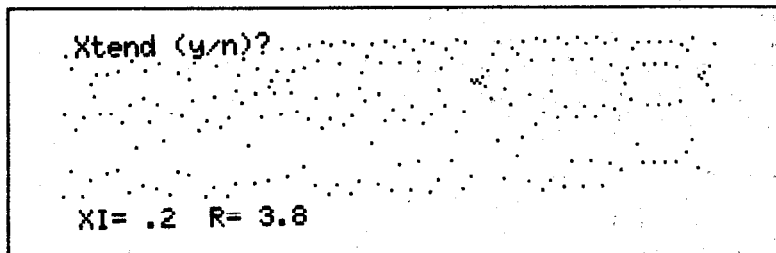

Figure 2. The logistic difference equation as a dynamical process (R=3.8), from the program in listing two.

probability. It is pre-determined by the equation and the starting conditions. Nor is any of the behavior in e. through i. expected intuitively by most persons educated in Euclidian geometry, algebra, calculus and probability theory, myself

PROGRAMMING

The three programs are structured similarly. The program to explore dynamical treatment of the logistic difference equation (Listing 1) is so similar to that for the sine wave (Listing 2) that, except for line number first digits, only four instructions are different. The program used to explore the Mandelbrot set (Listing 3) is a bit more complex than the other two. It deals with the color value of points in a plane, and is thus topographical and three dimensional, while the other programs deal with curved lines in but two dimensions. However, the added programming complexities of Listing 3 nest within the same general outline as Listings 1 and 2.

For the three programs, lines 100, 200, and 300 (I shall refer to them as line @00, because in each program these lines serve the same general purpose) names the program and identifies a reference page in Gleik's book, and the program date and author. Line @01 DEFINes the integer variables, and DIMensions those in the primary loop to speed up execution. As a REMark for reference only, the initial character of the remaining numeric variables, which are automatically treated by the M100 as double precision, are also DEFINed.

Many variable and counter symbols appear in all three listings. J counts program loops and represents pixel positions or columns from West to East, the value of 0 representing the leftmost column on the screen. K similarly counts loops representing the South to North pixel positions or rows, 0 being programmed to represent the bottom row on the screen. M counts pixels set with the PSET com-

mand, i.e. turned on or black. XI and YI represent initial user input or starting point for the experiment. Other definitions are discussed in following paragraphs under the appropriate heading.

Line @02 writes to the screen an explanation of the purpose of each program, while line @03 instructs the user how to end the pause created by line @04. Lines @05-@07 request user input, and establish limits where needed to avoid a program bomb. Line @08 initializes the other variables. Lines @10-@21 print data to the screen. Lines @25-@52, discussed in more detail in later paragraphs, increment counters and reset variables appropriately, solve the primary equations iteratively in line @30, turn screen pixels on appropriately in line @50, and branch and loop conditionally. Line @30 sets the independent variable(s) equal to the last value of the dependent variable(s) before recalculating. It also contains an ESCape capability that directs the program to lines @65-@67. They, in turn, offer the option of looping back to line @05 to run the program again from scratch - perhaps with different user input variables - or of returning to the main menu. Since the M100 counts from 0 at the top of the screen to 63 at the bottom, the value of K is subtracted from 63 in line @50 to plot 0 at the bottom of the screen.

LISTINGS 1 and 2

Line numbers @00, @02, @06 and @30 differ in the two listings in regard to title, description, input limits, and equation for study. The symbol R is used for the initial user input of a constant parameter, ratio or rate. If population is studied in Listing 1 then R represents the reproduction rate in creatures per creature per cycle. The variable Y represents the

equation solution value for cycle J while X represents the equation solution value of the previous cycle, J-1. In the study of a population with annual fecundity, a cycle would equal one year. In both listings the value of X is limited to less than 1 unit, e.g. one million persons or the sine of 90 degrees. R is also limited so that the maximum (full screen) value of Y is less than 1.0.

On the first pass through the program when M=0, Y is set equal to initial user input value, XI, in line @08 and execution jumps from line @10 to line @31. Line @31 scales the Y data for plotting by multiplying Y by 63, and converts double precision Y to single precision K. If you wish to experiment with wider user input limits in lines @05-@06, then line @32 will save either program from producing a BASIC error message. Line @32 is otherwise unneeded. However, you may wish to change the Y scale to accommodate real population numbers, in which case line 132 should probably also be changed so the population will "crash" at any value less than 1.

On subsequent loops line @30 sets independent variable X equal to the previous value of the dependent variable Y, before recalculating.

Line @50 plots initial user input, XI, in column 0. If 240 iterations (J=0 through 239) have been executed and the result plotted, line @51 routes the program to line @60. If not, line @52 loops back to line @25 for the next pass through the loop.

Lines @60-@62 offer the option of extending a parabola or sine experiment beyond 240 pixels. A "Y" or "y" user response resets J to 0, and loops back to line @10 where the screen is cleared and initial data printed to the screen. M con-

included. How about you? If I had written this same program some years ago, I probably would have believed there was a bug in it. Incidentally, the transitions to an increased number of period values that are evident at $R = 3.2, 3.5, 3.565$ and 3.8 are referred to as bifurcations by chaoticists. You may wish to experiment further and identify a more precise value of R at which these bifurcations occur.

Note, too, that increasing R can be thought of as driving the system harder. This concept seems particularly apropos where the equation represents electrical or mechanical systems, but it applies to natural systems as well.

Edward Lorenz, a meteorologist at MIT, was a seminal influence in the progress of chaos mathematics. While studying weather dynamics he discovered and wrote (in 1963) about this sensitive dependence on initial conditions. He is perhaps best known for his original work with the three difference equations

governing convection as it approaches turbulence, and the "Lorenz attractor", a fascinating part of chaos which, unfortunately, is beyond the scope of this article.

"HUMPED" EQUATIONS AND THE FEIGENBAUM CONSTANT

Mitchell Feigenbaum, who joined the Los Alamos National Laboratory in 1974, was an early chaos explorer and original thinker. He discovered that the kind of behavior we have seen with the parabola is universal for dynamical systems involving "humped" equations (1976). Run Listing 2, which substitutes the first 180 degrees of a sine wave for the parabola, and you will see very similar results. Feigenbaum discovered that bifurcations appear with the same regularity, expressed as a constant ratio, for all "humped" equations. Listing 2, which substitutes a sine wave for the parabola, demonstrates the similarity.

tinues to increment the total number of cycles as long as the program keeps running with the same user input.

LISTING 3

The symbol R in Listing 3 represents the calculated ranges of the real and imaginary (X and jY) coordinates of the points to be covered by the experiment, and for which results will be plotted and printed on screen. Variables beginning with X and Y represent the real and imaginary coordinates of various points in the imaginary plane. XI and YI are user input for real and imaginary coordinates of the midpoint of the area to be investigated. XC and YC are the coordinates of each point, C , being tested. XT and YT are temporary stand-ins for the X and Y equation solutions in loop $J-1$ that enable correct solution of the X and Y coordinates again in loop J . The variable ZM would be defined as an integer except for the fact that at the larger magnifications its value exceeds the integer limit of 32,767. Variable I counts the number of iterative solutions to the Mandelbrot equation. N counts pixels - hence points - in the experiment space that are not within the Mandelbrot set.

Line 308 initializes the counters and independent variables. Initially J and K are both 1. Column 0 and row 0 are reserved for scale markers. The first data column is thus column 1, and the first data row is row 1. Line 308 also adjusts for the desired magnification in terms of pixels per linear unit requested by the user in line 307. Magnification steps increment pixels per linear unit up or down by a factor of 8. Increasing the magnification scale by one step (e.g. from 3 to 4) will increase the pixels per linear unit and decrease linear units per

pixel by a factor of 8. Thus both the area of the plane represented by a pixel and the total area of the experiment will decrease by a factor of 64, but the screen display will remain the same size. Line 308 also calculates the minimum values of coordinates to be plotted, XN in the horizontal X or real dimension, YN in the vertical jY or imaginary dimension, so that XI and YI are centered on the marker scales. Further, the coordinates of the initial point C to be tested, and which will be plotted in the lower left hand corner of the grid, are determined as XC and YC . Also, in the first pass through the program, line 308 sets X equal to XC and Y to YC .

Line 310 sets markers around the four sides of a block of pixels at the left of the screen to bound a section of the imaginary plane. Line 311 prints the user determined constants to the screen and execution jumps to line 331. The screen has been laid out to accommodate the BASIC maximum of 14 digits, plus exponent for each of the constants P, R, XI and YI .

On all subsequent passes through the outermost loop, line 330 sets temporary variables XT and YT equal to the previous equation solution values of X and Y to be used in calculating the next values of X and Y . If the equations squaring the point values look odd, remember that the Y coordinate includes an imaginary factor, j , equal to the square root of -1.

Lines 331-332 test whether or not solving the equation dynamically has caused either the X or jY component, X or Y , to exceed a value of plus or minus 2 or the number of solution iterations, I , to reach 100, and if so to branch to another line. If solution points are on the way to infinity, and C is thus not within the

Mandelbrot set, then line 331 increments the N (pixels Not set) counter and directs the program to line 320 to print the results. If iterations have reached 100, then line 350 sets the appropriate pixel and increments the counter M to total the number of points tested that are within the Mandelbrot set. Line 352 branches back to line 320 to update the changed data on the screen before the next pass through the primary loop. The semicolons following the data elements in line 321 are needed to prevent scrolling since the data elements are printed on the last line on the screen. Although the data range of the experiment, and the pixel size, are based on 64 pixels, only 63 are actually plotted horizontally and 62 vertically. Marker rows and columns are protected to help in measuring the location of specific topographical features for subsequent magnified investigation. This is accomplished in lines 325 and 326 by incrementing J only if it is less than 63 and K if it is less than 62.

If the experiment is complete, and $J=63$ and $K=62$, then line 326 repeats continuously in order to maintain the graphic on the screen. At this point a GRPH/ESC message will call *DUMP.CO* or *CHDUMP.BA* to send the graphic to a printer. (The CAPS LOCK key must not be depressed.) BREAK is the only way to escape from this loop, but it destroys the graphic. Both these programs appeared in the May 1990 issue of P100, and may be downloaded from the P100 BBS. I found *CHDUMP.BA* very convenient to load and use.



MATHEMATICAL PROGRAMMING

THE MANDLEBROT SET

Another fascinating part of chaos is what is known as the Mandelbrot set. A Frenchman working at IBM, Benoit Mandelbrot, is generally considered the first of the important and original chaos thinkers and seminal writers. He investigated the result of dynamically treating an equation for a point in the imaginary plane, where a point $C=(X+jY)$, when j is the square root of -1 . He studied the equation $Z2=Z1^2+C$, where $Z1$ equals $Z2$ from the prior iteration and $^$ represents exponentiation. With certain starting values of C , the value of $Z2$ increases to infinity. For other values of C the value of $Z2$ either stabilizes or varies chaotically at less than infinity. Those points, C , for which $Z2$ stabilizes or varies chaotically but does not increase to infinity are said to be in the Mandelbrot set. It is as though zero and infinity both have an attraction for $Z2$ - and are thus "attractors" - and each exerts a pull on $Z2$, with one or the other winning for each value of C .

Mandelbrot plotted a multicolor topological map representing the number of cycles required for the equation to reach infinity for each point in the plane. An impatient man, unable to wait for infinity, he used a "fence" value of something less than infinity to identify those cases for which the value of $Z2$ appeared to be on the way to infinity. The lovely, lacy, colorful

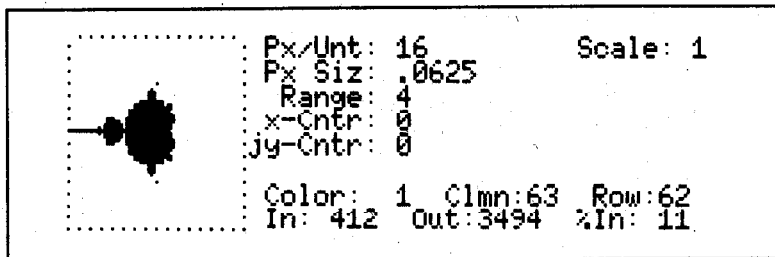

Figure 3. The plot of the Mandelbrot set at a magnification scale of one.

Mandelbrot's color map by observing the "color" reported for each location.

The program has a zoom capability. By specifying a larger and larger number of pixels per unit, and thus smaller and smaller ranges for the graphic display, you can look at a location on the boundary of the set in greater and greater detail. Even without the color, however, as you zoom in on the boundary of the set, a similar though different chaotic pattern is displayed. I found that understanding Listing 1, especially lines 330-332, and running it for the series of values shown in Table 1, provided an understanding of the Mandelbrot set and its chaotic boundary that was not clear from simply viewing the widely published color displays.

I suggest you first try the series of magnifications and locations shown in Table 1. The first magnification (16 pixels/unit) shows the Mandelbrot set plotted on a rather coarse grid, each pixel having a length and width of $1/16$, or $.0625$, and with the real and imaginary coordinates of $0,j0$ centered (approximately) in the graphic as seen in Figure 3. Subsequent magnifications zoom in on the right hand boundary of the valley formed by the two major circular segments of the set. Each pixel covers a smaller and smaller part of the boundary area. You may wish to run each magnification overnight, since processing is slow, especially for the greater magnifications where a larger proportion of the "colors" are nearer 100 than 0. The point specified by the user is always centered.

It might be interesting to expand the graphic to 64 by 64 characters on paper and print the initial letter of Red, Yellow, Green, etc, for varying numbers of iterations required to reach the "fence". Or you may wish to compile the program to run it faster or modify and move it to your PC to run it in color.

CONCLUSION

Chaos math is the mathematics of process, not of state. Many natural processes and their results can now be analyzed and explained mathematically. Turbulence in populations, in streams, in the boundary between convection and boiling, in the action of the human heart, in the formation of snow flakes, in the formation of leaves on a tree, appear to be the result of dynamical systems following mathematically deterministic though chaotic processes.

These three programs just scratch the surface. Also, we have glossed over the important chaos concepts of attractors, fractals, and self-similarity. But for me these programs provided the first clear understanding of a significant part of what is meant by the mathematical term chaos. I hope they do the same for you.

For a fascinating, non-mathematical history of the development of chaos mathematics I recommend "CHAOS; Making a New Science", by James Gleick.



You can get a feel for
Mandelbrot's color map
by observing the
"color" reported for
each location.

graphics representing a segment of the boundary of the set at different magnifications have been widely published. The boundary appears chaotic, not smooth. And as you zoom in on the boundary, you see a somewhat similar, but not identical, pattern. Since the finite boundary of the set at scale 1 contains the self similar and increasingly long boundary seen at greater scale values, i.e. increasing magnifications, the dimension of the boundary is said to be "fractal", Mandelbrot's contraction of fractional.

THE CHAOTIC BOUNDARY

Listing 3 replicates Mandelbrot's experiment, except that as yet the M100 will not display color. The program, however, increments a displayed color value, each time a point tested is found to fall inside or outside the set. The value 100 represents black, and in this case the pixel is colored appropriately. The row and column in which the pixel is located is also shown. The program uses a fence value of plus or minus 2 on either the ordinate or the abscissa, within 100 cycles, as a proxy for infinity. The number of cycles executed before reaching this fence, is reported as the color of the point. You can get a feel for

MATH PROGRAMMING

```

300 'LISTING 3 - CAOSMB P231 8/21/91 Cop
yright 1991 by Wm. M. Lowerre Jr.
301 DEFINT A,I,J,K,M,N:DIM X,Y,XT,YT,I,XC,
YC,J,N,K,M,P'DEFDBLP,R,X,Y,Z
302 CLS:PRINT"Plots the Mandelbrot set:"
:PRINT:PRINT" where Z2=Z1^2+C, (Z1 = Z2
Prior.)":PRINT:PRINT"Z1,Z2,C = Points i
n the imaginary plane.":PRINT" Plots C
if -2<Z2<+2 after 100 cycles.":PRINT" S
ame limit on ordinate and abscissa."
303 PRINT" (Tap any key to continue
.)";
304 A$=INKEY$:IFA$=""THEN304
305 CLS:PRINT"Enter mid-point of square
section of imaginary plane to test fo
r inclusion inMandelbrot set."
306 PRINT:INPUT" x component of midpoint
";XI:PRINT:INPUT"jy component of midpoin
t";YI:
307 CLS:PRINT@48,"1 - 16 pixels/u
nit":PRINT@88,"2 - 128":PRINT@128,
"3 - 1,024":PRINT@168,"4 - 8,192
":PRINT@208,"5 - 65,536":PRINT@248,"6
- 524,288":PRINT@288,"7 - 4,194,304";
:INPUT" W h i c h
scale";A:IFA<LORA>7THEN307
308 I=0:J=1:K=1:M=0:N=0:ZM=2*8^A:R=64/ZM
:P=R/64:YN=XI-R/2+P:YI=YI-R/2+P:XC=XN:YC
=YN:X=XC:Y=YC
310 CLS:PSET(0,63):PSET(64,63):FORIM=4TO
63STEP4:PSET(0,IM-1):PSET(64,IM-1):PSET(
IM,0):PSET(IM,63):NEXT
311 PRINT@12,"Px/Unt.":2*8^A:PRINT@31,"S
cale.":A:PRINT@52,"Px Siz.":P:PRINT@92,"
Range.":R:PRINT@132,"x-Cntr.":XI:PRINT@
171,"jy-Cntr.":YI:GOTO331
320 PRINT@252,"Color:"USING"###";I:PRINT
@263,"Clmn:"USING"###";J:PRINT@272,"Row:"
USING"###";K
321 PRINT@292,"In:"USING"###";M;:PRINT@
301,"Out:"USING"###";N;:PRINT@311,"%In:
"USING"###";(100*M)/(M+N);
325 I=0:X=0:Y=0:IFJ<63THENJ=J+1:XC=XC+P:
GOTO330
326 J=1:XC=XN:IFK<62THENK=K+1:YC=YC+PELS
EIFINKEY$=""THEN326ELSE326
330 XT=X:YT=Y:X=XT^2-YT^2+XC:Y=2*XT*YT+Y
C:IFINKEY$=CHR$(27)THEN365
331 IFX>2ORX<-2ORY>2ORY<-2THENN=N+1:GOTO
320
332 IFI<100THENI=I+1:GOTO330
350 PSET(J,63-K):M=M+1
352 GOTO320
365 PRINT@0,"RUN(y/n)?"
366 A$=INKEY$:IFA$=""THEN366
367 IFINSTR("Nn",A$)THENMENUELSE305

```

End of listing.

Listing 3: This program plots the Mandelbrot Set.



ULTRASOFT HAS 'EM!!! WE'VE GOT 'EM ALL!!!

The Hard-to-Find Accessories,
Software and Peripheral Solutions You Need
For Your Laptop, Notebook, and Palmtop!!!

We Support the Following Models
by Telephone, Fax, or Mail Order:

Tandy 100/102/200
Tandy WP-2
Tandy 1100 FD/1110HD
Tandy 1400 LT/FD/HD
Tandy 1500 HD
Tandy 1800 HD
Tandy 2800 HD
Tandy 2810 HD
Tandy 3820 HD
Panasonic CF-150/170/270
Panasonic CF-370/380/480
HP 95LX Palmtop
Atari Portfolio Palmtop
Poqet PC-Computer
Sharp PC3000 Palmtop

We Also Carry:

The Kodak Diconix 180 si/701
and the Canon BJ-ex/20 Portable Printers

We've got those hard-to-find:

Carrying cases for Laptop & Printer,
and overseas 220V & 240V AC Adapters
In Stock for all you globetrotters, too!!!

WE HAVE THE SOLUTIONS FOR ALL YOUR LAPTOP, NOTEBOOK AND PALM TOP NEEDS!!!

Call, Fax, or Write Today
for a FREE Catalog

Please specify the Make and Model of your Laptop, Notebook, or Palmtop.



1 Transborder Drive, PO Box 247
Champlain, NY 12919

Tel: (514) 487-9293

Fax: (514) 487-9295

9-5 EST Mon-Fri

VISA, MC, and AMEX Orders Accepted!!!

Also, Government & Educational P.O.'s!!!

Quantity Discounts Available!!!

Canadian and Dealer Orders Welcome!!!

Circle 134 on reader service card.

COMPATIBILITY: All computers

Brother, What a Printer!

The New HJ100i from Brother International.

by Marc Fraser

The Brother HJ-100i is a single-sheet bubble jet printer whose main purpose in life appears to be the "portable office". At 12.2"x8.5"x1.9" and weighing in at a mere 4 pounds (without the optional battery), it has about the same footprint as most current notebook PCs and is about 2/3 the weight. This means that a user can pack both this printer and his notebook, the power adapters, a small surge suppressor, mouse and paper in a single case weighing about fifteen pounds. When necessary, the printer's optional battery can make this combination absolutely unbeatable for the person on the go. The

The printer's optional battery make this combination unbeatable for the person on the go.

stated battery life of approximately 40 printed sheets means that your trip report can be typed, formatted and printed in near-laser quality while you wait for your connecting flight out of Pittsburgh (and no power plug in sight!).

FEATURES

The HJ-100i is factory configured with an IBM Proprinter X24e emulation as print mode 1 of three modes. Mode 2

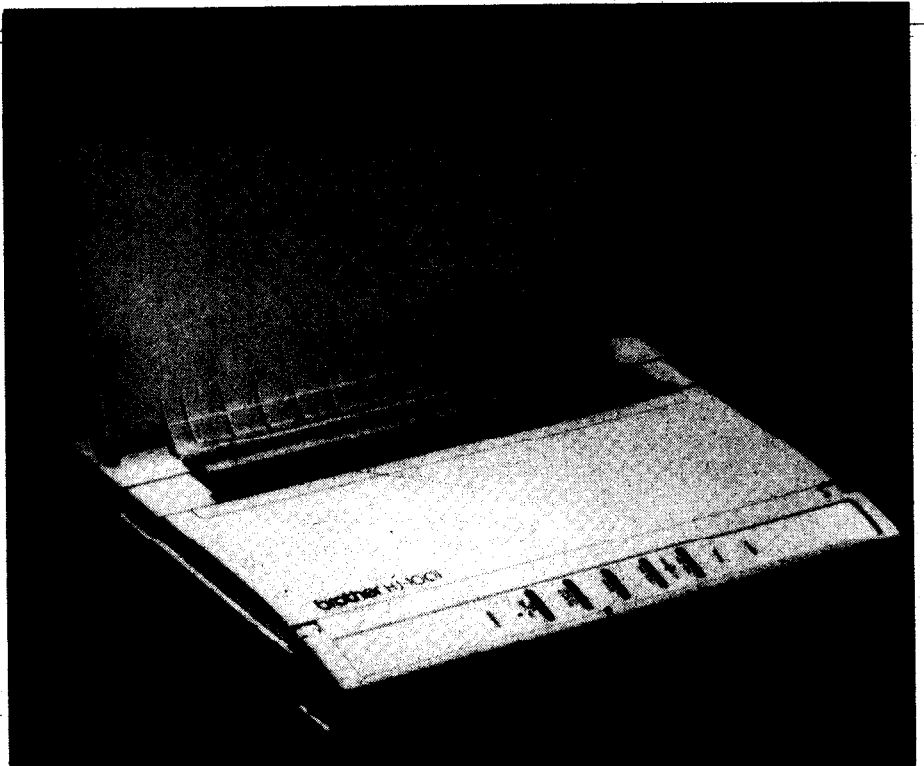

Light, compact, efficient, the Brother HJ-100i is now available.

is its native HJ-100i emulation, Mode 3 is an Epson LQ-510 emulation. The printing modes are selected by means of a bank of DIP switches located beneath the paper cover. If a change of print modes is necessary, then a simple flip of switches 10 and 11 with the tip of a pen will change from Mode 1 to Mode 2 or 3. With switch 10 ON, the printer is in Mode 2, or bubble jet emulation. Switch 11 selects the Epson LQ-510 emulation. The other DIP switches are used for setting the cut-sheet feeder, graphics density (normally high), automatic linefeed, page length, character set, automatic carriage return, alternate graphics mode, buffer size and code page. Brother sets

these options at the factory such that, for average printing needs, no changes have to be made to the default settings. I believe that most users can and will use the default mode of printing without ever having the need to investigate the other modes. A new user has to do nothing more than remove the printer from its carton and packing material, carefully install the ink cartridge (the instruction manual is very clear on this topic), connect the power adapter and printer cable and begin printing.

Speaking of the manual, it appears daunting at first at about 200 pages, until you realize that it is presented in three languages - English, French and Ger-

Portable 100 BACK ISSUES

With over 60 issues, and hundreds of articles, *Portable 100* is THE source for information, programs, and applications for your Tandy Portable Computer. But how do you find what you need among all those issues? The answer is the updated *Portable 100 Article Index*. Covering every issue from September 1983 to the combined summer 1989 issue, the index is designed to make it simple for you to find what you need. And at a cost of only \$9.00 (postage and handling included), you should buy one today! If you have last year's index, don't despair. Update your index by adding our special 1988-1989 Update Index. It's a bargain at just \$4 (P&H included).

And what do you do when you find an article you want? Easy. First check the back issue chart below for back issue availability. If the issue is available, just order it using the handy order form (\$5.00 each, postage and handling included). If it isn't, don't despair. Photocopies of any article in a sold-out issue cost just \$2.50 each. Simply list the article, or articles, by title, author, and issue, enclose payment, and in just a short time you'll have the articles in hand.

Month	83	84	85	86	87	88	89	90	91
January			Not Published						Not Published
February									
March			OUT		Not Published				
April		OUT				OUT	OUT		
May		OUT				OUT			
June		OUT							
July		OUT		OUT		combined July/Aug. issue	combined July/Aug. & Sept. (Summer 1989) issue	Not Published	combined July/Aug. issue
August		OUT							
September	Premier Issue					OUT			
October		OUT							
November									
December						OUT			

Portable 100, Back Issue Department, P.O. Box 428, Peterborough, NH 03458

- Send me the 1983-Summer 1989 *Portable 100 Article Index* for \$9.00 (Postage & Handling included).
- Send me the Sept. 1988-Summer 1989 *Portable 100 Update Article Index* for \$4.00 (P&H included).
- Please send me the back issues I've indicated (\$5.00 each; shipping & handling charges included).

PAYMENT MUST ACCOMPANY ORDER

- CHECK OR M.O. MC AMEX
- VISA TOTAL ENCLOSED _____

CARD# _____ (Be sure to include entire card number) EXP. DATE _____

NAME _____

STREET ADDRESS _____

CITY _____

STATE _____ ZIP _____

Please allow six to eight weeks for delivery



Introduction

The Brother HJ-100i is a single-sheet bubble jet printer whose main purpose in life appears to be the "portable office". At 12.2"x8.5"x1.9" and weighing in at a mere 4 pounds

Mode 2, or bubble Switch 11 selects the LQ-510 emulation. DIP switches are used for the cut-sheet feeder density (normally h automatic linefeed, character set, autor

A sample of the print and graphics from the Brother bubble-jet, reproduced here at 100%.

man. Still, the sixty or so pages of English are well-written, easy to understand and well structured so that a new user can readily find all of the necessary operating instructions. There appear to be none of the grammatical and spelling errors commonly found in so many multi-lingual user manuals. The manual is divided into eight sec-

tions - General, Installation Procedures, Operation, Function, Maintenance, Troubleshooting Guide,

For most users, the printer will work properly right out of the box.

Specifications and Appendices. General describes the do's and don't's of the printer regarding excessive temperature, top loading and other abuse issues. The next three sections are concerned with connecting, powering and printing procedures. These are the sections that will be most helpful to the new user. Brother has made this printer so easy to

set up for the general user that in most cases the printer will work properly right out of the box. As far as troubleshooting is concerned, there is one page devoted to a small number of potential problems that could crop up in operating the printer. The most common remedy for an error condition is to switch the power off, then on again to reset the printer to its default settings. Among the appendices is a handy section on document and envelope printing hints, with suggestions for border sizes and printing areas.

There are two options available for the HJ-100i; a Ni-Cd battery pack and a sheet feeder mechanism. The battery pack will prove useful to those who need to be truly portable, while the sheet feeder will allow uninterrupted printing of multiple-page documents. Neither of these reasonably-priced options is reviewed here.

COMPATIBILITY

The HJ-100i was put through its paces on a suite of applications including *Lotus 1-2-3 Rel. 2.3*, *DesignCAD 2D*, *Avango Publishing System* and multiple *Microsoft Windows 3.1* applications (*Quicken*, *Works for Windows*, *MathCAD*, *Write and Notepad*).

We will begin with the *Windows* applications. *Windows 3.1* contains five



Options for your
100/102/200!

extRAM:

a 32K byte read/write memory expansion that fits into the option ROM socket inside the "T" 100, 102 or 200. Multi-talented...

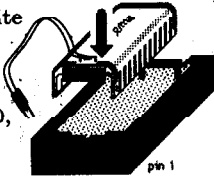

• **RAM-file-bank:** Double your space for .DO, .BA and .CQ files. Put them in the extRAM and call them back instantly when you need them. The ever-evolving EXTRAS software has great capabilities for "T" enthusiasts, too, to create custom program loaders.

• **ROM-emulator:** No more single-ROM limitation! Swap ROM images on command from disk, or from your NODE rampac or data-pac, or from RS232. Fast and easy. Works with most ROMware.

(Circle 83 on reader service card)

The software comes with each extRAM in the form of listings and instructions in a 40+ page manual. Optionally, to save typing, you can order a disk with all the programs in machine-readable form. We accept Visa/Mastercard, check, money order (© U.S.) or qualified P. O. © 1989 by Paul Globman. Software R2D2X © 1990 by Wilson Van Alst.

extRAM—new low price...

See also our new XR4 Ad,
This issue!!

extRAM.....	\$69ea	_____
for? M100 T102 T200		_____
software disk.....	\$15ea	_____
for? tpdd ms-dos Mac		_____
ROMBO...\$9ea or \$96/12		_____
EPROM 27C256	\$6ea	_____
subtotal		_____
+ (CA res. only tax 7.25%)		_____
+ UPS shipping		3.00
Total.....		_____

Rombo:

our tried and true adapter that allows rom developers and enthusiasts to use stock EPROMs (27C256) in the option ROM socket in the 100/102/200.

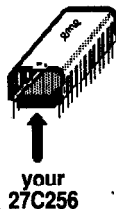

(Circle 81 on reader service card)



eme systems

voice: (510) 848-5725
fax: (510) 848-5748
2229 5th St., Berkeley, CA 94710

HARDWARE REVIEW

TrueType fonts which can be exclusively enabled in all *Windows* applications. This is accomplished through the Control Panel under Fonts. Release 3.1 has printer drivers for the Proprinter X24e, the Canon BJ-10e (which I have reason to believe is the same printer as the HJ-100i) and the Epson LQ-510 among its default set of drivers. These are installed from the Control Panel under Printers. Once this is done, any *Windows* program will print gorgeously to the HJ-100i in any of the available emulations.

Avagio also has a driver for the Proprinter X24 and a Canon bubble jet, and its output quality truly shines on the HJ-100i.

Finally, neither *DesignCAD 2D* nor *Lotus 1-2-3 Release 2.3* has a driver for the X24e or a bubble jet printer. These programs must be set to use a driver for an IBM Graphics Printer. This driver will provide more than adequate output quality for either program.

As may be apparent from this discussion, the user will have to experiment with the drivers available in the applications to be used with the HJ-100i in order

afford the wait, the line quality of the CAD output will amaze you! "Jaggies" are almost non-existent and text is completely readable, even when reduced in size.

SUMMARY

The Brother HJ-100i printer is a high-quality, quiet (45dB) printer that is easy to set up and use. I found it capable of producing high density characters and graphics in the applications tested with a minimum of fuss in determining the proper software setup.

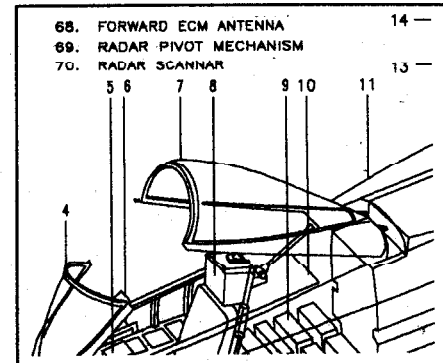

A sample of the HJ-100i's CAD/CAM abilities.

PRODUCT SUPPLIERS AND SPECIFICATIONS

Brother HJ100i Ink Jet Computer Printer — \$495.00

Physical Dimensions: 12.2"(W) x 8.5" (L) x 1.9" (H)

Weight: About 4.0 lbs.

Acoustic Noise Level: Under 45 dB(A)

Printing Method: Serial Inkjet printing

Printing Speed: 83 cps in 10 cpi LQ mode; 83cps in 10cpi NLQ mode

Printing Direction: Bidirectional in text mode; Unidirectional in image mode

Character Set: Mode1/Mode2: IBM character set 1, 2 and 3; Mode 3: Italics character set and graphics character set

Print Width: Max. 203 mm (8")

Input Buffer: 37 KB(Mode1/Mode2) or 20 KB(Mode 3)

Download Buffer: Max. 34 KB(Mode1/Mode 2) or 18 KB(Mode 3)

Power Supply: AC adapter or optional NiCd battery pack

Power Source: USA/Canada: AC 120 V60 Hz 30 W

Brother International Corporation
200 Cottontail Lane, Vantage Court,
Somerset, NJ 08875.
(908)356-8880, fax (908) 469-7636.

It is as close to
noiseless as any
mechanism can be.

to achieve the print quality that is possible with this printer.

Another of the truly welcome features of this printer is its noise level. Stated in the manual as "Under 45 dB(A)", I can say that it is as close to noiseless as any mechanism can be. The printer can be running in one room and it will very likely not be heard from an adjacent room. This is perfect for those late-night sessions with your check-balancing software or CAD work.

With all of these strong points, there must be at least one weak area of performance, and there is. The stated print speed is 83 cps in character mode. This is slow in comparison to current-technology 24-pin dot matrix printers, but the high output quality of the bubble jet system more than compensates for its speed. For example, a two-page letter in *Microsoft Works* may take a minute per page, and a *DesignCAD* drawing at high print density can take up to twenty minutes for an "A" size sheet. If you can

COMPATIBILITY: Models 100/102

CONTaCT.100

Telemarketing for the Model 100.

By Clyde C. Price, Jr. and George McLin

CONTaCT.100 is a telemarketing program for the Model 100/102 outlined by Clyde C. Price, Jr. [CIS# 76616,3452] and programmed in BASIC by George McLin [73607,1255] in less than 4K, and is a copyrighted commercial program.

CONTaCT.BA starts dialing with a given number and dials sequentially, like the much more expensive "Surveyor" computers, covering EVERY number in an exchange if you wish, and recording the operator's notes. For personal (voice) contacts, CONTaCT.BA provides a template to record a name, address and notes about the interview under the heading of the number called. This record-template could be rewritten for other specific formats without too much difficulty.

We recommend that you conserve memory by keeping your script and/or survey questions on a separate printed sheet, and only enter responses.

This record-template could be rewritten for other specific formats.

Equipment needed for this telemarketing system includes the program, a TRS-80 Model 100 or Tandy Model 102 with modem cable, disk or cassette storage, and (optional) a printer, and of course, your own sales or survey script. (The program could also be adapted easily for the Model 200.)

After loading the program, connect the Radio Shack direct connect modem cable (Cat. No. 26-1410) to the computer, then connect the beige wire to the outlet or phone line, and the grey end to the telephone or headset. The built-in modem will dial the numbers (pulse, not tone). If a number is in the RSUME#.DO, you may answer "Start with a new number?" with "N", and the program will dial the last number you dialed-1. Otherwise, start with your target exchange, for example,

```
0 CLS:PRINTCHR$(27);CHR$(112);"
  CONTACT.100 (C)1989           ";CHR$(27)
);CHR$(113);"                George McLin & Clyde
  Price                        [73607,1255] [7661
6,3452]                         TeleMarketing program for
  the TRS-80                    Model 100/102 & a live
operator.                        ";
```

```
1 PRINTCHR$(27);CHR$(112);" <B>usy <O>u
  t of service <N>o answer    <D>at
  a <V>oice session          ";CHR$(27);CH
R$(113);" ";CHR$(27);CHR$(112);"    (c
  lose NOTES with ";CHR$(34);"END";CHR$(34
);".)                               ";PRINT#1,"";
2 GOSUB125:CLS:MAXFILES=5:CLEAR256:PRINT
  CHR$(27);CHR$(113);:INPUT"Start with a n
  ew number";GG$:IFGG$="N"THENRUNSEIFGG
  $="THENMENU
3 CLS:INPUT"Starting number";Q:IFQ=0THEN
  44
4 CLOSE:CLS:OPEN"CALIST.DO"FOROUTPUTAS1:
  GOTO6
5 CLOSE:CLS:OPEN"CALIST.DO"FOROUTPUTAS1:
  OPEN"RSUME#.DO"FORINPUTAS3:Q=VAL(INPUT$(
  9,3))
6 FORJJJ=1TO8
7 PRINT#1,Q;
8 Q=Q+1:NEXTJJJ
9 CLEAR500:CLOSE:OPEN"CALLED.DO"FORAPPEN
  DAS1:OPEN"CALIST.DO"FORINPUTAS2:MMMM=0
10 DEFINTA-Z
11 DIMML(3)
12 CLS
13 PMS="7I1E"+CHR$(0)
14 PH$=INPUT$(9,2)
15 ONERRORGOTO40
16 IFLEN(PH$)=0THEN44
17 PH$=PH$+CHR$(0)
18 V=VARPTR(PMS)
19 AD!-PEEK(V+1)+PEEK(V+2)*256
20 CALL6118,0,AD!
21 FORN=0TO-1STEP-1
22 READA,B
23 A1=A+B*256
```

Continued.

Listing 1. The CTC.BA file for automatic speed dialing.

COMMUNICATIONS

```

24 ML(X)=A1+65536*(A1>32767):X=X+1
25 N=(B=0):NEXT
26 V=VARPTR(PH$)
27 AD1=PEEK(V+1)+PEEK(V+2)*256
28 CLS:PRINT"Dialing...";
29 CALL21200
30 CALL21293,0,AD1
31 CALL21172
32 X=0:CD=0
33 V=VARPTR(ML(0))
34 Y=VARPTR(X)
35 CALLV,0,Y
36 CD=(X=0)
37 GOTO45
38 RESTORE39:GOTO14
39 DATA205,239,110,119,201,0
40 IFMMM-11THEN42ELSEMMM-MMM+1
41 RESUME25
42 OPEN"RSUME#.DO"FOROUTPUTAS3
43 PRINT#3,(VAL(PH$)+1):IFTAG$="Q"THEN74
  ELSERUN5
44 CLOSE:MAXFILES=1:KILL"CALIST.DO":MENU
45 TAG$=INKEY$:IFTAG$=""THEN45
46 IFTAG$="B"THEN53
47 IFTAG$="N"THEN54
48 IFTAG$="O"THEN55
49 IFTAG$="V"THEN56
50 IFTAG$="D"THEN68
51 GOTO45
52 PRINT#1,"1Data: ";PH$;": ";TIME$:GOSUB
  119:GOTO38
53 PRINT#1,"1Busy: ";PH$;": ";TIME$:GOSUB
  115:GOSUB119:GOTO38
54 PRINT#1,"1No answer: ";PH$;": ";TIME$:
  GOSUB115:GOSUB119:GOTO38
55 PRINT#1,"1Out of service: ";PH$;": ";T
  IME$:GOSUB115:GOSUB119:GOTO38
56 CLS:OPEN"INFO.DO"FORAPPENDAS4
57 INPUT"First name";FNAM$:INPUT"Last na
  me";LNAM$:INPUT"St. number or P.O.Box";A
  DR$:INPUT"City";CTY$:INPUT"State";STT$:I
  NPUT"Zip";ZIPS
58 PRINT#4,PH$;"- ";DATE$;" - ";TIME$:PR
  INT#4,LNAM$;",";FNAM$:PRINT#4,ADR$:PRIN
  T#4,CTY$;",";STT$:PRINT#4,ZIP$
59 CLS:PRINT"Notes:"
60 INPUTNTS$:IFNTS$="END"THEN62
61 PRINT#4,NTS$:GOTO60
62 GOSUB115
63 IFQITS$="1"THEN66
64 IFQITS$="2"THEN67
65 GOSUB117:GOTO63
66 PRINT#4,"":CLOSE4:GOTO38
67 PRINT#4,"":CLOSE4:TAG$="Q":PH$=STR$(V
  AL(PH$)+1):GOTO42
68 CLS:PRINT"1...Continue calling":PRINT
  "2...Quit":PRINT"3...Go into TERM mode"
69 DAT$=INKEY$:IFDAT$=""THEN69
70 IFDAT$="3"THEN72ELSEIFDAT$="1"THEN123
  ELSEIFDAT$="2"THEN124
71 GOTO69
72 CLS:PRINT#1,"Data(tried): ";PH$;": ";T

```

```

IME$:KILL"CALIST.DO"
73 OPEN"RSUME#.DO"FOROUTPUTAS3:PRINT#3,(
  VAL(PH$)+1):CALL21589
74 CLEAR2000:CLOSE:F$="CALLED.DO"
75 OPENF$FORINPUTAS1
76 LINEINPUT#1,Z$
77 CLS:PRINT"Sorting CALLED file..."
78 B=1
79 E=4
80 N=1
81 N=N+1
82 LINEINPUT#1,Z$
83 IFEOF(1)THEN85
84 GOTO81
85 CLOSE
86 DIMD$(N)
87 OPENF$FORINPUTAS1
88 FORI=1TON
89 LINEINPUT#1,D$(I)
90 NEXTI
91 CLOSE1
92 GOSUB100
93 KILLF$
94 OPENF$FOROUTPUTAS1
95 FORI=1TON
96 PRINT#1,D$(I)
97 NEXTI
98 CLOSE
99 GOTO44
100 Z5=N
101 Z5=INT(Z5/2)
102 IFZ5=0THEN114
103 Z2=1:Z3=N-Z5
104 Z1=Z2
105 Z4=Z1+Z5
106 IF(MID$(D$(Z1),B,(E-B)+1))<(MID$(D$(
  Z4),B,(E-B)+1))THEN111ELSE107
107 Z6$=D$(Z1):D$(Z1)=D$(Z4):D$(Z4)=Z6$
108 Z1=Z1-Z5
109 IFZ1<1THEN111
110 GOTO105
111 Z2=Z2+1
112 IFZ2>Z3THEN101
113 GOTO104
114 RETURN
115 CALL21179:FORWT=1TO2000:NEXTWT
116 CLS:PRINT"1...Continue calling":PRIN
  T#2...Quit"
117 QITS=INKEY$:IFQITS=""THEN117
118 RETURN
119 IFQITS$="1"THEN121ELSEIFQITS$="2"THEN1
  22
120 IFQITS$="Q"THEN122
121 RETURN
122 TAG$="Q":GOTO42
123 CALL21179:FORWT=1TO2000:NEXTWT:QITS=
  "1":GOTO52
124 CALL21179:FORWT=1TO2000:NEXTWT:QITS=
  "2":GOTO52
125 IFINKEY$=""THEN125
126 RETURN

```

End of listing.

8750000 (no dashes or commas). You can cover EVERY number in the exchange, including all unlisted, new, and data numbers. The effort of calling the out of service numbers will probably be less than that of coding a(n incomplete? outdated?) list of numbers into an ADRS.DO, which was the reason for writing the program.

There are several things the operator must do manually:

You code whether the line is usy, <N>oanswer, <D>ata, <O>ut of service, or <V>oice. Use only caps.

Make your own notes on voice calls, concluding with "END" at the beginning of a line to resume the program.

(Very important!) You must "hang up" the line yourself, since the M100 hardware cannot do this. Then code <1> to resume calling or <2> to quit the program.

The CALLED.DO (record of Out, No-answer, Busy, and Data numbers) is sorted on exit from a session, and a "1" heads each entry, so the operator may use the PD program RENUM to number this file sequentially. In a "total saturation" effort, you

may later rename *CALLED.DO* as *ADRS.DO*, and use *TELCOM* to Find the remaining numbers in order, and take your remaining notes on paper or in a "*TRYAGN.DO*."

Without *RENUM*, you could print the *CALLED.DO*, use the hardcopy as a checkoff list, and use *Find* in *TELCOM* to locate the last 4 numbers.

Of course all the resulting *DO*document files can be printed out for follow-up. If your printer is set to supply its own linefeeds, you can use the *PRINT (SCREEN)* command to create hardcopy notes during the interview.

We encourage all who use this program for surveying or telemarketing to be courteous and considerate. The door-to-door salesman is almost dead. ("He was shot by a drug-dealer.") Tele-

You can cover every number in the exchange, including all unlisted, new, and data numbers.

marketing is much safer for the salesperson and less threatening to the prospect. *Sales need prospects*, and "cold calling" is one sure way to get started in any area. Instead of paying for prospect lists, or using the local "street directory" which is outdated as soon as it's published, or using a dedicated "Surveyor"-type computer that is now *illegal* in many areas, a salesperson can employ his/her multi-use laptop to do the number-generating, dialing and record-keeping that a *computer* should do, and lets the salesperson do what a *human* should do. The savings might entice a salesperson to acquire a laptop just for this use.



Your own Program on a Rom

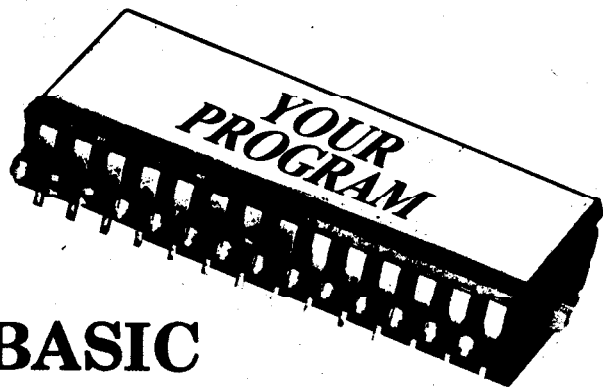

8K or 32K

Your BASIC or machine code program on a custom ROM ready to snap into your Model 100 or Tandy 200.

You can't tell your program from a built-in. Starting at \$50.00 each. Minimum order of 10.

Quantity pricing as low

as \$15.00

Distributed by

Another fine product from the innovative people at PCSG

Tri-Mike Network East

Post Office Box 372 Peterborough, NH 03458

1-603-588-2010

VISA MASTERCARD C.O.D

COMPATIBILITY: All computers.

ViVa 2400 Pocket Modem

A lightweight, pocket-sized portable modem.



by Ken Cheung

Today's laptop and notebook computers are getting smaller, more powerful, and less costly; so are the peripherals. A classic example is the ViVa 2400 baud pocket modem. Having the size and weight of a pocket calculator, this modem is truly portable.

The modem supports 300, 1200 and 2400 bps and is fully Hayes Smart-modem compatible, so you shouldn't have software incompatibility problems. The modem offers half or full duplex operation, auto-dial/auto-answer, tone or pulse dial, and self-test diagnostics.

There is also nonvolatile memory. This enables you to store configuration profiles, and allows storage of up to four telephone numbers. The absence of switches and jumpers also makes modem configuration less cumbersome.

One of the positive things about the ViVa pocket modem, besides its compact size, is the presence of LED indicator lights on the front panel. Because the modem plugs into the back of your computer's serial port, you may not be able to see the LEDs. However, it's still a good idea. Having indicator lights enables you to see the status of your modem and monitor the connection. There are four indicator lights in the Viva pocket modem: modem ready, carrier detect, high speed and low battery. Respectively, these lights indicate if your modem is on and working, if a proper connection is made, and whether the modem is operating at 2400 bps. Since the modem runs on a 9-volt battery, having the battery low light is an asset.

Despite what some critics say, a modem that is powered by battery is as good as one that is telephone line powered. The only disadvantage I see, besides the extra weight, is that you have to worry about the battery running down.

For a laptop computer user this is nothing new, since she/he should already be used to monitoring the computer's battery pack. I highly recommend a rechargeable NiCd 9-volt battery. They last longer and save money over time.

Besides, most pocket modems that get their power through the telephone line also get power from your serial port. As a consequence, you may get a shorter battery life from your computer. Also, the WP-2, the Model 102, and other computers do not supply power to the RS 232 port and so the line-powered modem will not work.

The modem comes with a rugged, beige-colored case. On its side is the telephone line input jack, an on/off switch, and the DC input jack. There are also 2 knobs up front that allow you to secure the modem to the serial port of your computer.

A significant drawback is the lack of a quality speaker. Even though I turned up the volume as high as possible using the "AT" commands, and could hear the modem dialing, I could barely hear the ringing. This means that you'll have to rely heavily on the communications software you are using, by noting the connection status message on the screen. Another detraction is the absence of data compression and error checking protocols. Although not a common option on most 2400 baud modems, it would be beneficial to have.

The package comes with everything you need to get started: a telephone cable, 9-Volt battery, DC adapter if you choose not to use a battery, a gender changer (25 to 9 pin), a comprehensive manual, and a shareware version of *Pro-comm* communications software. The manufacturer has made sure that even the novice and the unprepared can start telecommunicating as quickly as possible. Installation and setup took me only

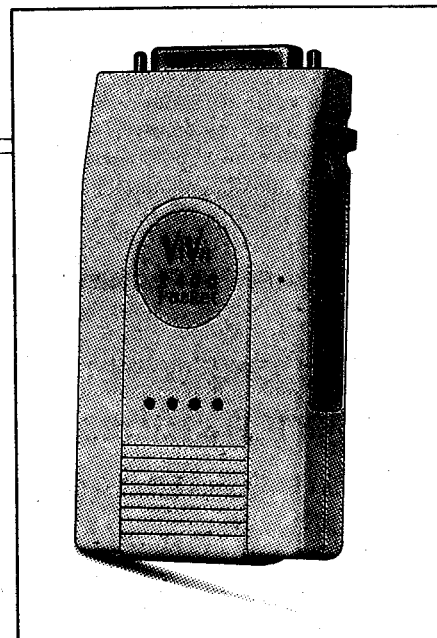

The battery-operated ViVa 2400 pocket modem.

a few minutes, and the manual has a quick-installation section.

How much does the modem cost? Surprisingly less than what you might expect — \$149, a price you don't see on pocket modems.

The ViVa pocket modem is a definite must for people who use a portable computer and want to telecommunicate. With its compact size and lightness, it's ideal for any laptop/notebook user. Although it may lack some features, you won't find a price this low for a pocket modem with such exceptional performance.

PRODUCT SPECIFICATIONS & SUPPLIERS

Computer Peripherals Inc.
667 Rancho Conejo Blvd
Newbury Park, California 91320
(805) 499-5751 . (800) 854-7600

ViVa 2400 bps Pocket Modem — \$149.

COMPATIBILITY: Tandy 100, 102, 200's.

Contab.BA, Part Two

Temperature conversions, continued.

by R. Jim Siebert

Last month we introduced *CONTAB* as the program that just grew - as all programs do. They are supposed to grow in usefulness and compactness, but they usually also grow in size and complexity.

It would be very poor planning that would not allow nine related, but independent programs to take up less space if packaged and run on a common menu — besides taking up far less directory space. But, it is bigger — 8159 Bytes.

Really, it's too big for long-term practical use, but I display it because it very nicely shows off how to integrate number and function keys in a menu using single keystroke - that is, without having to use the *ENTER*. It allows more than nine selections to be listed on a menu without using letters. Although using letters works well, it just takes a little different planning and usually many more program lines.

To use the function keys in a *BASIC* program, they first must be "turned on." Line 2 is the one that turns on function keys 7

It shows off how to integrate number and function keys

and 8. The menu tells you that key 7 is then programmed to return to the menu of the program, and key 8 is to return to the main menu of the computer (lines 1000 and 1001). Naturally, these keys could be whatever you want them to be. For instance, you could program key 3 to hold the value of *PI*. Incidentally, the value of *PI* can be obtained to a greater accuracy by using $2*ATN(3d13)$ instead of $4*ATN(1)$. The difference will be noted out in the eleventh place. This difference will not be seen on the Model 102, only on the Model 100.

Note that line 85 has exactly 6 commas, one for each of the undefined function keys. You can turn "on" as many of the function keys as you wish to define, as in line 2, but a comma must be included for those not used as in line 85.

Lines 80, 85, and 90 are the selectors for the menu. The process won't work if line 80 and 85 are combined with a colon.

```

1 'CONTAB conversion tables RJS 2/88:'
  O$=Formula identifier, O=numerical input
  t - reset at each subdivision
2 KEY(7)ON: KEY(8)ON:U$="####.##":D$="##
  .####":GOTO9
3 O=VAL(LEFT$(A$,LEN(A$)-1)):' isolates
  & evaluates the numerical part of the
  input$
4 O$=RIGHT$(A$,1):RETURN:.' picks off
  the letter used to select the proper conversion
  formula
5 Q$=INKEY$:C$=A$:IF Q$>CHR$(42)ANDQ$<CHR$(58)ORQ$>CHR$(64)ANDQ$<CHR$(91)ORQ$>CHR$(96)ANDQ$<CHR$(123)THENA$=A$+Q$:PRINTQ$;:IFQ$=CHR$(44)THENA$=C$
6 IFQ$>CHR$(57)THENGOSUB3:RETURN:.' L5 restricts
  input to letters & characters - and accumulates
  the numbers until a letter is input then drops thru
  to L6 where it is sent to SubL3 for evaluation.
7 GOTO5:.' Prevents a crash in case some other than
  a number or letter is input - resets
9 CLS
15 PRINT"           Measurement Converter  R
  JS ":PRINT
17 LINE(20,0)-(220,7),1,B
20 PRINT"  1)Temperatures           6)Velocities"
30 PRINT"  2)Lineal                   7)Power"
40 PRINT"  3)Areas                     8)Torque"
50 PRINT"  4)Volume                   9)Pressure"
60 PRINT"  5)Wt (mass & den) [7]ret f8 )menu"
70 PRINT"Select desired measure";
80 Q$=INKEY$
85 ONKEYGOSUB,,,,,1000,1001:IFQ$=""THEN
80
90 CLS:PRINT:ONVAL(Q$)GOTO100,200,300,400,500,600,700,800,900
99 ' L80,85,90 allow mixing number and function
  keys in the same menu for one key action
100 PRINT:PRINT" Enter temperature follo

```

Continued.

CONTAB.100 converts metric measurements to English.

TANDY WP-2 MEMORY

128K \$54
32K \$12

Improve your memory! Add a 32K or 128K ram disk to your WP-2. The 32K part is exactly the same as Tandy's at a significantly lower price. The 128K part has the same low-power characteristics of the 32K part. Battery life is not a problem! Prices include S&H, installation instructions, 90-day warranty. CA residents add 7.75% tax. Send check or money order to:



MicroMime

P.O. Box 28181
Santa Ana, CA 92799

CIS 70346,1267 Phone/Fax (714) 545-1765

WEETAX

The Weekly Tax Program
For periodic maintenance of input to your personal income tax return.

- table-driven panel fields
- your labels and default data
- optional, prompted annotation
- year-to-date summary printout
- resets to start next year
- only 377 bytes reside in RAM
- standardizes format
- promotes time management
- provides current accounting
- avoids the year-end crisis
- keeps you in control

DVI: \$44.95 ppd PDD: \$49.95 ppd for Ultrasoft Disk Power™ 100

Reviewed March 1989, Portable 100
Software Versand, Points West No. 158
3131 W. Cochise Dr., Phoenix, AZ 85041
Phone: 602-997-1533 1989 TMO

*50% OFF EPROM DEVELOPMENT SOFTWARE

Now it's cheaper than ever to put your program on a ROM.

RBASIC (Now \$99.00) The original program enabling you to put BASIC programs on a ROM.

PRO-RBASIC (Now \$172.00) (Upgrade \$50.00) Professional version (V5.00). Put larger or multiple BASIC programs on a ROM.

SECRETS OF ROM REVEALED (Now \$25.00) All you need to know to call standard ROM routines from an Option ROM.

C100 (Now \$350.00) Put 'C' programs on a ROM.

M100/102 Technical series, Hardware Eproms, Burners, Molex, EZ-FLEX. (Call for list & prices.)

*Limited offer. 30 day money back guarantee.

To Order, call (818) 951-5240

King Computer Services, Inc.

10350 Samoa Avenue, Tujunga, CA 91042

Circle 37 on reader service card.

Circle 127 on reader service card.

Circle 116 on reader service card.

The process can be made to work as a single line but only if the function key feature is not included, somewhat as line 111, 211, etc. Line 90 must be separate because line 85 "falls thru" when the next to last part of line 85 fails to test true. Computers are truth seekers. As long as the line finds truth, it will keep going. But if a part of a line fails, then it ignores whatever else is on that line and goes directly to the next line. The ELSE and the OR commands are important exceptions to this general rule.

Line 80 tells the computer that the variable Q\$ will consist of a single keystroke, and since it is \$ then it doesn't have to be only a number. It may be anything on the keyboard. The first part of line 85 tells it to look for a function key and act on it should it find one. The last part of line 85 tells it to loop back to 80 if it finds a null (plain nothing).

These numbers in line 90 do not need to be in nice neat spacings of 100.

Line 90 clears the screen, gives us a blank line and then translates Q\$ into a number. Computers can't calculate with a number if it is defined as a \$. To the computer it might as well be a Roman Numeral. So, VAL(Q\$) translates the keystroke into a number. The ON part tells it to act on it as soon as it is translated, and the GOTO part tells it where to do the acting.

These numbers in line 90 do not need to be in nice neat spacings of 100, but can be in any spacing and can even be in any sequence. At this place in the program, if the letter "2" were typed, even without an ENTER, it would be translated immediately into the numeral "2." This tells it to go to the second number listed 200, which then tells it to go to the program line number 200. The contents of the first part of line 200 will be printed on the screen and the program will go to line 5.

Line 5 was discussed in some detail last month. If you have recovered from that huge bite, then please note that this subroutine is used twice in the 600 section. Doing this allows us to easily

```
wed by f,c,r,k (f)ahrenheit, (c)elsius,
(x)rankin, (k)elvin":GOSUB5
110 PRINT" to be changed into (f,c,r,k)
?"
111 C$=INKEY$:IFC$=""THEN111
113 CLS:PRINT
115 IFO$="f"THENO=(0-32)*5/9
117 IFO$="c"THENO=0: ' the reference
119 IFO$="k"THENO=0-273.16
121 IFO$="r"THENO=(0-459.69-32)*5/9
155 IFC$="r"THENPRINTA$;" = ";USINGU$;0*
9/5+32;:PRINT" degrees Fahrenheit"
157 IFC$="c"THENPRINTA$;" = ";USINGU$;0;
:PRINT" degrees Celsius"
159 IFC$="k"THENPRINTA$;" = ";USINGU$;0+
273.16;:PRINT" degrees Kelvin"
161 IFC$="r"THENPRINTA$;" = ";USINGU$;0*
9/5+32+459.69;:PRINT" degrees Rankin"
199 Q$="":A$="":GOTO100
200 PRINT:PRINT" Enter length then (i)nc
h,(f)oot,(y)ard,(m)il(e),(m)m,(c)m,(M)ete
r,(K)m,(k)not, fre(q)uency":GOSUB5
210 PRINT" to be changed into(i,f,y,m,c,
M,K,k,q)?
211 C$=INKEY$:IFC$=""THEN211
213 CLS:PRINT
215 IFO$="i"THENO=0*2.54
217 IFO$="f"THENO=0*12*2.54
219 IFO$="y"THENO=0*36*2.54
221 IFO$="e"THENO=0*12*5280*2.54
223 IFO$="m"THENO=0/10
225 IFO$="c"THENO=0: ' the reference
227 IFO$="M"THENO=0*100
229 IFO$="K"THENO=0*100000
231 IFO$="k"THENO=0*12*2.54*6076.11549
233 IFO$="q"THENO=30000000000/0
255 IFC$="i"THENPRINTA$;" = ";USINGU$;0/
2.54;:PRINT" inches"
257 IFC$="f"THENPRINTA$;" = ";USINGU$;0/
(2.54*12);:PRINT" feet"
259 IFC$="y"THENPRINTA$;" = ";USINGU$;0/
(2.54*36);:PRINT" yards"
261 IFC$="e"THENPRINTA$;" = ";USINGD$;0/
(2.54*12*5280);:PRINT" miles"
263 IFC$="m"THENPRINTA$;" = ";USINGU$;0*
10;:PRINT" millimeters"
265 IFC$="c"THENPRINTA$;" = ";USINGU$;0;
:PRINT" centimeters"
```

Continued

```

267 IFC$="M"THENPRINTA$;" = ";USINGU$;O/
100;:PRINT" Meters"
269 IFC$="K"THENPRINTA$;" = ";USINGD$;O/
100000;:PRINT" Kilometers"
271 IFC$="k"THENPRINTA$;" = ";USINGD$;O/
(2.54*12*6076.11549);:PRINT" knots"
273 IFC$="q"THENPRINTA$;" = ";USINGU$;30
000000000/O;:PRINT" Cycles/sec"
299 Q$="":A$="":PRINTGOTO200
300 PRINT:PRINT"Enter Area followed by s
q.(i)n.,sq.(f)t. sq.(y)d.,sq.mil(e),
sq.(c)m.,sq.(M). sq.(K)m., (a)cre, (h
)ectare":GOSUB5
310 PRINT" to be changed into(i,f,y,e,c,
M,K,a,h)?
311 C$=INKEY$:IFC$=""THEN311
313 CLS:PRINT
315 IFO$="i"THENO=O*6.4516
317 IFO$="f"THENO=O*144*6.4516
319 IFO$="y"THENO=O*1296*6.4516
321 IFO$="e"THENO=O*5280^2*144*6.4516
323 IFO$="c"THENO=O::' the reference
325 IFO$="M"THENO=O*10000
327 IFO$="K"THENO=O*10000000000
329 IFO$="a"THENO=O*144*6.4516*43560
331 IFO$="h"THENO=O*100000000
355 IFC$="i"THENPRINTA$;" = ";USINGU$;O/
6.4516;:PRINT" sq. inches"
357 IFC$="f"THENPRINTA$;" = ";USINGU$;O/
(144*6.4516);:PRINT" sq. feet"
359 IFC$="y"THENPRINTA$;" = ";USINGU$;O/
(36*36*6.4516);:PRINT" sq.yards"
361 IFC$="e"THENPRINTA$;" = ";USINGU$;O/
(5280*5280*144*6.4516);:PRINT" sq. miles"
363 IFC$="c"THENPRINTA$;" = ";USINGU$;O;
:PRINT" sq. centimeters"
365 IFC$="M"THENPRINTA$;" = ";USINGU$;O/
10000;:PRINT" sq. meters"
367 IFC$="K"THENPRINTA$;" = ";USINGU$;O/
10000000000;:PRINT" sq. Kilometers"
371 IFC$="a"THENPRINTA$;" = ";USINGU$;O/
(144*6.4516*43560);:PRINT" Acres"
373 IFC$="h"THENPRINTA$;" = ";USINGU$;O/
100000000;:PRINT" hectares"
399 Q$="":A$="":GOTO300
400 PRINT:PRINT" Enter volume then cu
.(i)n.,cu.(f)t., cu.(y)d.,(o)z.,(q)t.,
(g)al.,(b)bl., (c)c.[ml],(l)iter,cu.(M)
":GOSUB5
410 PRINT" to be changed into(i,f,y,o,q,
g,b,c,l,M ?"
411 C$=INKEY$:IFC$=""THEN411
413 CLS:PRINT
415 IFO$="i"THENO=O*(2.54^3)
417 IFO$="f"THENO=O*((2.54*12)^3)
419 IFO$="y"THENO=O*((2.54*36)^3)
421 IFO$="o"THENO=O/.338
425 IFO$="q"THENO=O*(2.54^3)*231/4
427 IFO$="g"THENO=O*(2.54^3)*231
429 IFO$="b"THENO=O*(2.54^3)*231*55
431 IFO$="c"THENO=O
433 IFO$="l"THENO=O*1000
435 IFO$="M"THENO=O*(100^3)
455 IFC$="i"THENPRINTA$;" = ";USINGU$;O/
(2.54^3);:PRINT" cu. inches"
457 IFC$="f"THENPRINTA$;" = ";USINGU$;O/
((2.54*12)^3);:PRINT" cu. feet"
459 IFC$="y"THENPRINTA$;" = ";USINGU$;O/
((2.54*36)^3);:PRINT" cu. yards"
461 IFC$="o"THENPRINTA$;" = ";USINGU$;O/
((2.54^3)*231/128);:PRINT" fluid ounces"

```

```

463 IFC$="q"THENPRINTA$;" = ";USINGU$;O/
1056.71;:PRINT" quarts"
465 IFC$="g"THENPRINTA$;" = ";USINGU$;O/
((2.54^3)*231);:PRINT" gallons"
467 IFC$="b"THENPRINTA$;" = ";USINGU$;O/
((2.54^3)*231*55);:PRINT" Barrels"
469 IFC$="c"THENPRINTA$;" = ";USINGU$;O;
:PRINT" cubic centimeters or ml"
471 IFC$="l"THENPRINTA$;" = ";USINGU$;O/
1000;:PRINT" liters"
473 IFC$="M"THENPRINTA$;" = ";USINGU$;O/
1000000;:PRINT" cu. meters"
499 Q$="":A$="":GOTO400
500 PRINT:PRINT"Enter Mass (weight) foll
owed by (G)rain, (o)z., (p)ound, (t)on,
(m)g., (g)ram, (M)etric ton;:PRINT"Fo
r Density g/(c)c, lbs/cu(f)t, lbs/(a)l":G
OSUB5
510 PRINT:PRINT" to be changed into(G,o,
p,t,m,g,M,c,f,a)
511 C$=INKEY$:IFC$=""THEN511
513 CLS:PRINT
515 IFO$="G"THENO=O*.0648
517 IFO$="o"THENO=O*28.3495
519 IFO$="p"THENO=O*453.59
521 IFO$="t"THENO=O*453.59*2000
523 IFO$="m"THENO=O/1000
525 IFO$="g"THENO=O
527 IFO$="k"THENO=O*1000
529 IFO$="M"THENO=O*1000000
531 IFO$="c"THENO=O
533 IFO$="f"THENO=O*453.59/1728/2.54^3
535 IFO$="a"THENO=O*453.59/231/2.54^3
555 IFC$="G"THENPRINTA$;" = ";USINGU$;O/
.0648;:PRINT" grains"
557 IFC$="o"THENPRINTA$;" = ";USINGU$;O*
16/453.59;:PRINT" ounces"
559 IFC$="p"THENPRINTA$;" = ";USINGU$;O/
453.59;:PRINT" pounds"
561 IFC$="t"THENPRINTA$;" = ";USINGU$;O/
(453.59*2000);:PRINT" tons"
563 IFC$="m"THENPRINTA$;" = ";USINGU$;O*
1000;:PRINT" milligrams"
565 IFC$="g"THENPRINTA$;" = ";USINGU$;O;
:PRINT" grams"
567 IFC$="M"THENPRINTA$;" = ";USINGU$;O/
1000000;:PRINT" metric tons"
569 IFC$="c"THENPRINTA$;USINGU$;O;:PRINT
" grams/cc"
571 IFC$="f"THENPRINTA$;USINGU$;O/453.59
*1728*2.54^3;:PRINT" lbs/cu.ft."
573 IFC$="a"THENPRINTA$;USINGU$;O/453.59
*2.54^3*231;:PRINT" lbs/gal"
599 Q$="":A$="":GOTO500
600 PRINT:PRINT" Enter Velocity followed
by Miles/(h)r, miles/(s)ec,(K)ilometers
/hr,(k)ilometers/sec, (F)t/min, (f)t/sec
, (M)eters/sec, k(n)ots, Re(v)/min":GOS
UB5
605 IFO$="v"THENOSUB690:O=O*Q
610 PRINT"to be changed into (h,s,K,k,F,
f,M,v)"
611 C$=INKEY$:IFC$=""THEN611
613 CLS:PRINT
615 IFO$="h"THENO=O*.44704
617 IFO$="s"THENO=O*.44704*5280/3600
619 IFO$="K"THENO=O/3.6
621 IFO$="k"THENO=O/1000
623 IFO$="F"THENO=O*.3048/60
625 IFO$="f"THENO=O*.3048
627 IFO$="M"THENO=O
629 IFO$="n"THENO=O*.5148

```

Continued.

```

655 IFC$="h"THENPRINT$;" = ";USINGU$;O/
.44704;:PRINT"Miles/hr"
657 IFC$="s"THENPRINT$;" = ";USINGU$;O/
.44704/3600;:PRINT"miles/sec"
659 IFC$="k"THENPRINT$;" = ";USINGU$;O*
3.6;:PRINT"Kilometers/hr"
661 IFC$="k"THENPRINT$;" = ";USINGU$;O/
1000;:PRINT"Kilometers/sec"
663 IFC$="F"THENPRINT$;" = ";USINGU$;O/
.3048*60;:PRINT"ft/min"
665 IFC$="f"THENPRINT$;" = ";USINGU$;O*
3.281;:PRINT"ft/sec"
667 IFC$="M"THENPRINT$;" = ";USINGU$;O;
:PRINT"Meters/sec"
671 IFC$="n"THENPRINT$;" = ";USINGU$;O/
.5148;:PRINT"knots"
673 IFC$="v"THENGOSUB690:O=Q/O:PRINT" , "
;B$;" = ";USINGU$;O;:PRINT"rev/min"
689 Q$="" :A$="" :GOTO600
690 Q=O:B$=A$:A$="" :PRINT"Enter diameter
followed by (i)nches or (c)m ";:GOSUB5
:O=O*2*ATN(3D13)
692 IFO$="i"THENO =O*2.54/100/60:RETURN
694 IFO$="c"THENO=O/100/60:RETURN
700 PRINT:PRINT" Enter power followed by
(H)orse power, (k)ilowatts, (f)t.lbs/m
in, ft.lbs/(s)ec":GOSUB5
710 PRINT" To be changed into (H,k,f,s)"
711 C$=INKEY$:IFC$=""THEN711
713 CLS:PRINT
715 IFO$="H"THENO=O
717 IFO$="k"THENO=O*745.7/1000
719 IFO$="f"THENO=O/33000
721 IFO$="s"THENO=O/550
755 IFC$="H"THENPRINT$;" = ";USINGU$;O;
:PRINT" Horsepower"
757 IFC$="k"THENPRINT$;" = ";USINGU$;O/
.7457;:PRINT"kilowatts"
759 IFC$="f"THENPRINT$;" = ";USINGU$;O*
33000;:PRINT"ft.lbs/min."
761 IFC$="s"THENPRINT$;" = ";USINGU$;O*
550;:PRINT"ft.lbs/sec."
799 Q$="" :A$="" :GOTO700
800 PRINT:PRINT" Enter Torque then (f)t

```

```

.lbs, (i)n.lbs, in.(o)z":GOSUB5
810 PRINT" To be changed into (f,i,o)
811 C$=INKEY$:IFC$=""THEN811
813 CLS:PRINT
815 IFO$="f"THENO=O
817 IFO$="i"THENO=O/12
819 IFO$="o"THENO=O/12/16
855 IFC$="f"THENPRINT$;" = ";USINGU$;O;
:PRINT"foot pounds"
857 IFC$="i"THENPRINT$;" = ";USINGU$;O*
12;:PRINT"inch pounds"
859 IFC$="o"THENPRINT$;" = ";USINGU$;O*
12*16;:PRINT"inch ounces"
899 Q$="" :A$="" :GOTO800
900 PRINT:PRINT"Enter Pressure then (p)/
sq.in.,(i)n. of Hg, (m)m of Hg, (a)tmosph
heres, (f)t. of H2O, mil(l)ibars":GOSUB5
910 PRINT" To be changed into (p,i,m,a,f
,l)
911 C$=INKEY$:IFC$=""THEN911
913 CLS:PRINT
915 IFO$="p"THENO=O/14.7
917 IFO$="i"THENO=O/31
919 IFO$="m"THENO=O/760
921 IFO$="a"THENO=O
923 IFO$="f"THENO=O/16
925 IFO$="l"THENO=O/1013
955 IFC$="p"THENPRINT$;" = ";USINGU$;O*
14.7;:PRINT"pounds/sq.in."
957 IFC$="i"THENPRINT$;" = ";USINGU$;O*
31;:PRINT"inches of Mercury"
959 IFC$="m"THENPRINT$;" = ";USINGU$;O*
760;:PRINT" millimeters of Mercury"
961 IFC$="a"THENPRINT$;" = ";USINGU$;O;
:PRINT"atmospheres"
963 IFC$="f"THENPRINT$;" = ";USINGU$;O*
16;:PRINT"feet of water"
965 IFC$="l"THENPRINT$;" = ";USINGU$;O*
1013;:PRINT" millibars"
980 IFC$="n"THENPRINT$;" = ";USINGU$;O*
550;:PRINT" newton meters"
999 Q$="" :A$="" :GOTO900
1000 GOTO9
1001 MENU

```

End of listing.

handle rotational velocity and surface speed problems. A holding variable Q did have to be added as in line 690 since O will be redefined, and that value otherwise lost. The variable Q had been used previously, but there was no point to keep the value it held, so it was redefined to serve here. (No, I guess we really didn't use Q before. There in line 80 we used Q\$, and in line 90 we asked the computer to act on the numerical translation of Q\$, but we didn't define that value as Q.)

Let's have one more look at line 2 where U\$ and D\$ are defined. If we didn't have this, the calculated answers would be nine digits or longer. That would be not only confusing and lend an air of precision not warranted by the input, but it would also mess up our screen display. The PRINT# is a powerful and flexible programming tool, but it does have some quirks that need watching. First, it merely truncates the results, it doesn't do a true "round off." If improved accuracy is needed and is available from the input data, then add one more # to either U\$ or D\$ and then do your own round off when you copy down the results. I used only two places past the decimal for U\$ because that is more than what is needed for most common work. For more precision I chose four places past the decimal as in D\$ because that is about what is needed by a high precision operation.

It is very difficult and expensive to measure most things closer than a tenth of a thousandths. Anyone who gives answers

to a greater degree of precision than this is fooling himself and displaying his mathematical naivete. There can be no more degree of precision in the result of a mathematic operation than there exists in the input to the process. To put it simply, you can't have an answer out to a tenth of a thousandth if you did the original measure with a wooden yard stick.

For more information on the problem of rounding off numbers, study the BASIC commands of INT, CINT, FIX, and backslash division. When there are so many different ways of doing a simple task, it usually means that the task isn't so simple, after all. Think about it — if the limited space available in BASIC has so many commands that do what many people consider to be the same thing, have another look. They don't do the same thing.

You will note that some important torques have been left out of section 800. I simply ran out of energy to include Newton Meters and Kilogram Meters. The same is true of the metric pressures in section 900. For the scientific purists, the metric system uses lower case for fractional value prefixes and uses upper case for multipliers, but I wasn't very consistent, was I?

The value to these programs is in the two listed features, 1)the efficient blending of Number keys and Function keys for use in a single keystroke Menu, and 2) Quick entry of numerical data and letter identifiers without use of an ENTER keystroke.

SUPER HERO

boxes made with block graphics are much bolder. To illustrate, I've replaced the line graphics in last month's Figure 7 with block graphics. Figure 2 shows the changes I made to the letterhead file, and the printed results appear in Figure 3.

The "Wide Load Inc." company name is now completely surrounded by the full block character, ASCII 219. As your computer's manual (or last month's Figure 1) shows, this is produced on the Model T by pressing CODE-J (remember, case is important—"J" and "j" are different). Unlike line graphics, with the

full block you needn't use different characters for right and left sides, top and bottom, nor corners—this single character does it all.

You can even vary the shading if you like. ASCII characters 176-178 are full blocks, but with progressively darker shading from 176 to 178, and of course, the aforementioned 219 being completely black. By experimenting with different combinations of these, you can probably come up with some interesting effects.

Further down, the company address

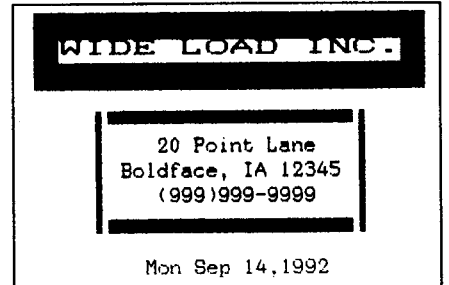

Figure 3. Here's the letterhead produced by the file in Figure 2, using block graphics for the boxes. Note the lack of corners in the box surrounding the company address and phone number.

and phone number section is now surrounded by some partial block graphic characters. These characters are more "fussy" about their positions than the full block—left, right, top, and bottom lines use different characters. The left vertical line is produced by ASCII 221 (press CODE-`<`), the right vertical line by ASCII 222 (CODE-`v`), the top horizontal line by ASCII 223 (CODE-`x`), and the bottom horizontal line by ASCII 220 (CODE-`y`).

The lack of corner characters when using partial block graphics makes the box look rather strange, as the top, bottom, and side lines don't connect. In this figure, the top and bottom lines come up a bit too short. By extending them at the expense of the right and left sides (Figure 4) we get a different effect. Top and bottom are now the "proper" length, but the sides now come up short (Figure 5). The effect isn't very pleasing in this case. In other applications such as an "open" effect may be desirable, so it's good to be

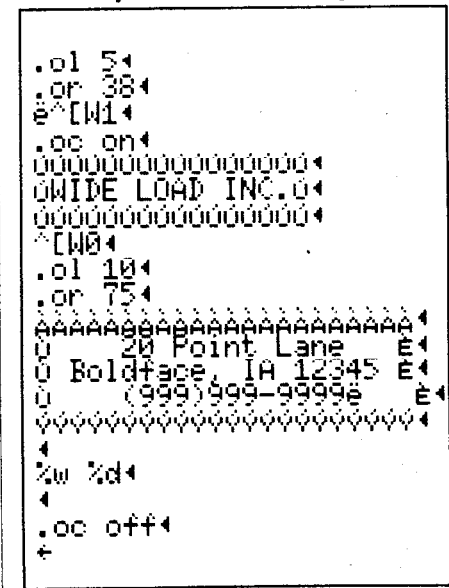

Figure 4. The partial block graphics have been slightly modified to show another variation. The corners on the lower box, however, still do not connect. Figure 5 shows the printed result.

BUILDING QUALITY CASES SINCE 1952

A.T.A. heavy-duty shipping to lightweight carrying cases

- 6 distinct product lines
- Over 20,000 standard designs

Custom measuring and designing available

CALL FOR OUR NEW CATALOG!

Call Today For More Information

ANVIL CASES

SUBSIDIARY OF ZERO CORPORATION

15650 Salt Lake Ave., City of Industry, CA 91745 • P.O. Box 1202, La Puente, CA 91744

(800) FLY-ANVIL (800) 359-2691

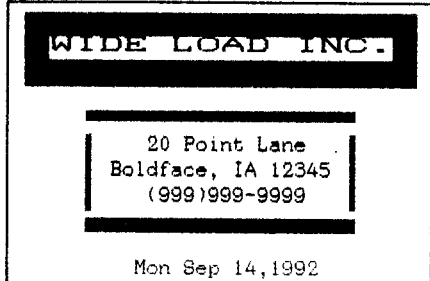

Figure 5. Here's the variation of the lower box produced by the file in Figure 4. While not suitable for this particular letterhead, the open corners in here and in Figure 3 might be effective in other situations.

familiar with the methods I've shown to produce them.

For this particular design I'd prefer the corners of the box to be closed. To achieve that, I chose to use the full block on the right and left sides, and partial blocks on the top and bottom, as shown in Figure 6. The result appears in Figure 7. (Actually, in "real life" I'd prefer the line graphics shown last month, but that wouldn't be very helpful in learning about block graphics, would it?)

There are the normal "bullet" characters, but we're trying to be creative here.

KIDS, DO TRY THIS AT HOME!

One change I'd like to have made to these figures, but didn't (being horrendously behind schedule, plagued by nicotine withdrawal, and intensely driven to take advantage of my unexpected freedom and 6,000-acre solitude) would be to adjust the spacing of the full-block box around the company name. The top line of the box smacks into the top of the text of the company name. The sides tend to crowd the text as well. I'd add another line or two above the text, a space or two on either side, and maybe another line below it, to open it up so the text isn't so cramped by the box. I'll leave that as an exercise for you, so you can play around and gain more experience through experimentation.

SPEAKING OF WHICH...

In all cases above, changing from line to block graphics was a snap. I simply replaced the existing characters in the file with the new ones. There was no need to add or rearrange spacing. So experimenting can often be very easy and well worth your while.

In my case, I simply overtyped the existing characters. While overtype mode isn't a feature of the Model T's built-in TEXT program, nor of Write ROM, it's easy to add in, using James Yi's TEXT+ utility. TEXT+ gives you the power to overtype characters, disable

```
.ol 54
.or 384
e~[w14
.oc on4
UUUUUUUUUUUUUUUUUUU4
WIDE LOAD INC.U4
UUUUUUUUUUUUUUUUUUU4
^TW04
.ol 104
.or 754
UAAAAAAAAAAAAAAAAAAAAU4
U 20 Point Lane U4
U Boldface, IA 12345 U4
U (999)999-9999e U4
UUUUUUUUUUUUUUUUUUU4
4
%w %d4
4
.oc off4
4
```

Figure 6. Mixing full blocks for the sides, with partial blocks for the top and bottom, produces the closed box shown in Figure 7, which is more suitable for this application.

word wrap, append to the paste buffer, and much, much more. It not only makes experimenting even easier, it enhances the power and flexibility to your day-to-day use of TEXT. It works very well with Super ROM and holds an exalted position on my "All-time Favorite Software" list.

You can get your own copy of TEXT+ by several methods: Type it in from the program listing in the March '91 issue of Portable 100; order the March '91 P100-To-Go disk, or download it from the Portable 100 BBS or CompuServe's Model 100 Forum.

FURTHER EXPERIMENTS

Now, why not do some more experimenting? Examine the other characters in IBM Character Set 2 (or those in your particular printer's character set) and see what other possibilities occur to you. Might the chevrons (ASCII 174 and 175) be useful? Could you use them to high-

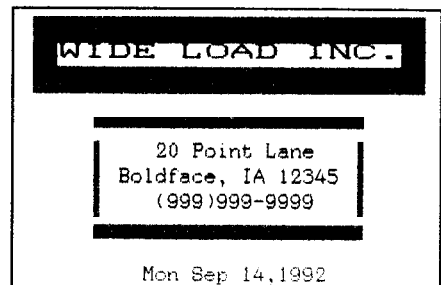

Figure 7. In this letterhead, produced by the file in Figure 6, both boxes are closed. Can you improve it by adding more space to the top box, so it doesn't crowd the text? Give it a try!

light the beginning of each of several special paragraphs, or each item in a list? (Of course, there are the normal "bullet" characters, ASCII 249 and 250, for this purpose, but we're trying to be creative here.) Could you string a bunch of them together to make a line? What would they (or any other character) look like in double-wide or double-high modes?

How about the square block, ASCII 254? Would a string of them look like a dotted line? It seems to me you could make a dotted box with those as well. You might even make another box around that one, for a double box.

Don't forget the foreign language characters, the scientific, mathematics, currency, and miscellaneous others. Next time you're writing about "three and one-half" of something, try using ASCII 171 to print the "one-half" part. ASCII 172 could be used for "one-quarter." Need to print the "cents" symbol? Try ASCII 155.

Just locate a desired character in your printer's character set, then find the Model T key combination with the same ASCII value. It's that simple!

LIONS AND TIGERS AND BEARS... OH MY!

Well, time to wrap this li'l puppy so I can go take a hike (literally). If all the proper miracles have occurred, this will appear in your November issue. One has already occurred: I've finally finished the column! And finally, it means I haven't been eaten by a bear ... nor, in a nicotine-withdrawal induced psychotic episode, vice versa.

See you next month!

Mike Nugent can be reached at Tri-Mike Network East, P.O. Box 372, Peterborough, NH 03458, tel. (603)588-2010; on CompuServe (71426,1201); on MCI Mail (1MNEAST); and on packet radio (WB8GLQ@KA1SRD.MA). If requesting a reply by postal mail, please enclose an SASE.



Ergonomic Keyboard Drawers from MicroComputer Accessories

Two of the most common keyboard problems are where to put the keyboard on a crowded work surface, and how to position it to maximize ease of use and comfort. Responding to this dilemma, MicroComputer Accessories, Inc. has introduced two new adjustable keyboard drawers with built-in padded wrist rests — one for desktop use, and one for underdesk use. Both drawers allow users to select a comfortable keying height that best suits their individual preferences and stature, and change keyboard heights instantly, even while keying.

Both drawers include a built-in padded wrist rest that helps support

the wrists for greater comfort. When opened the wrist rest provides a convenient storage compartment for small office items such as pencils, pens and paper clips. Mouse users can attach an optional Mouse Tray for right- or left-handed use.

The **Adjustable Keyboard Drawer - desktop** (#634) is \$99.95, the **Mouse Tray - desktop** (#6295) is \$19.95, and **Adjustable Keyboard Drawer - underdesk** (model #635) - \$79.95. **Underdesk Mouse Tray** (#601) is \$31.95. MicroComputer Accessories, 9920 La Cienega Blvd., P.O. Box 17032, Inglewood, CA 90308. (310) 645-9400. Or circle 61 on reader service card.

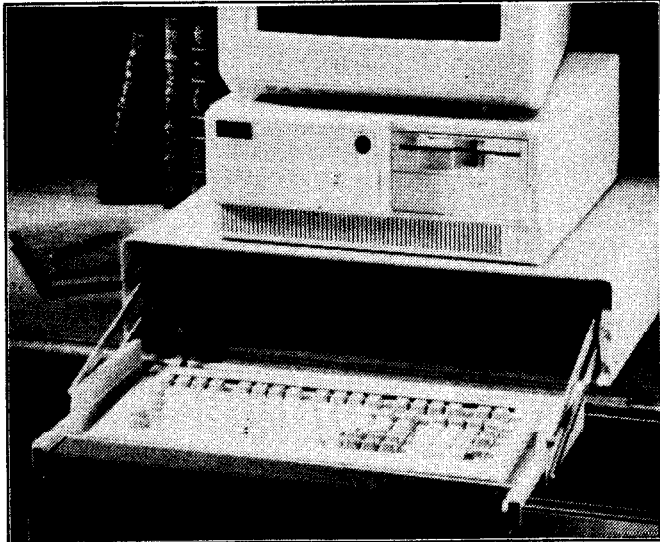

The Adjustable Keyboard Drawer desktop version with padded wrist rest/storage compartment from MicroComputer Accessories.

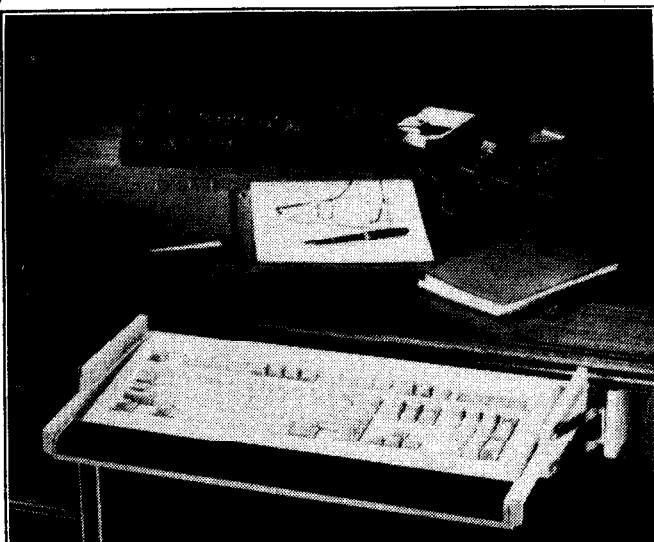

The Adjustable Keyboard Drawer - underdesk version.

Data Compression with SuperStor 2.0

The trouble with the Information Age is finding a place to put all the information. For PC users, this means a never-ending quest for increased storage capacity. Inevitably, the hard disk that seemed huge when first purchased comes to be cramped and inadequate. Owners of desktop PCs can always add disk capacity, but owners of hand-held, notebook and laptop computers don't have that option. So what do you do?

One solution lies in the technology called data compression. By downsizing data so that more can fit on an existing storage device, compression offers a simple and inexpensive alternative to buying new hardware.

SuperStor 2.0 is a simple file compression software, requiring no special commands during operation and is completely invisible during normal operation, compressing data automatically as it is stored and decompressing it when it is retrieved.

The latest version of the product, *SuperStor 2.0* introduces three unique features:

Universal Data Exchange — allows *SuperStor 2.0* users to exchange compressed data with other users via floppy disk. These other users can decompress and use the data, even if their PC's aren't equipped with *SuperStor 2.0*.

Automount — makes it simpler

to read and write compressed data on floppy disks.

Recompress — takes already-compressed data and compacts it still further.

Users have two options when installing *SuperStor 2.0* on their systems. First, they can choose the "Prepare" option, in which case *SuperStor 2.0* will automatically convert all existing hard disk files to compressed files. In the process, *SuperStor 2.0* will also defragment the disk. As an alternative, users can leave their existing files uncompressed and create a new disk partition for future, compressed files.

SuperStor 2.0 is fully compatible with *MS-DOS* (versions 3.31 and up), *Microsoft Windows* (including version 3.1) and *DR DOS* (versions 5 and 6.0). It is compatible with all hard drives, floppy disks, Bernoulli's and other removable media.

SuperStor is available through retail outlets in North America and Europe, including Egghead Discount Software, CompUSA, Electronics Boutique and Walden Software. Suggested retail price of *SuperStor 2.0* is \$139. Users of the earlier version, *SuperStor 1.3*, can upgrade to *SuperStor 2.0* for \$39.

Contact: Bob Gronski, AddStor, Inc., 3905 Bohannon Drive, Menlo Park, CA 94025. (800) 732-3133, fax (415)688-0466. Or circle 62 on the reader service card.

Quick Guide to CompuServe from Que

Getting connected to the world is easy with *Que's Quick Guide to CompuServe*. This book gives users a fluid overview of the spectrum of services and the essential system-wide commands that make each CompuServe connection a valuable one.

Designed to make information easy-to-find and easy-to-use, *Que's Quick Guide to CompuServe* defines CompuServe in simple segments. It includes how to connect to CompuServe using different phone networks and how to navigate CompuServe menus. Users get a complete look at the dozens of services and forums available, as well

as the quick-access "GO" codes.

With *Que's Quick Guide to CompuServe*, users discover the simple, smooth methods of using CompuServe's electronic mail. Plus, expert tips and strategies help users create messages and understand on-line abbreviations.

Que's Quick Guide to CompuServe is published by Que Development Group. Retail price is \$12.95. ISBN: 0-88022-825-3. Or circle 63 on the reader service card.



Changes your Model 100 into a totally different computer with capability you never thought possible.

LucidTM
on Snap-InTM ROM

Another fine product from the innovative people at PCSG!

Infoworld
rated Lucid's
performance
"excellent"

NOW
AVAILABLE
ON
M-200

TMNE says "Satisfaction Guaranteed
or your money back within 30 days!"

LUCID[®] is here now. It is on a ROM cartridge that snaps into the compartment on the back of your Model 100. It takes no memory to load and no memory for operating overhead. That means you have the full 29.6k bytes free to store your data.

First, LUCID[®] is memory conserving. It will let you build a large spreadsheet—255 row by 126 column capacity. You build huge spreadsheets in your Model 100's RAM that could consume 80 to 100K on a desktop computer.

Secondly, LUCID[®] is fast. LUCID[®] is so rapid, a 36 column corporate financial statement took less than 4 seconds to calculate.

Thirdly, LUCID[®] has features you won't find in most other spreadsheets. For example, when you type a label (text) it will cross column boundaries; in other words when you type a label or title it will appear as you type it irrespective of column or width. LUCID[®] also allows you to set column widths individually, and of course LUCID[®] has insert row and insert columns, as well as other standard features. LUCID[®] even lets your formulas refer to cells in other spreadsheet files.

Further, LUCID[®] has what no other spreadsheet has: Cut, Copy, and Paste. It uses the same keys as Cut and Paste in TEXT, but here's the difference: it takes all the formulas with it when you paste and they all automatically recalculate with the entire sheet.

And here is what is really amazing. You can copy or cut from one spreadsheet and paste into another spreadsheet or even a TEXT file.

LUCID[®] supports all BASIC math functions as well as Log, sine, cosine, tangent, exponentiation and other sophisticated math functions.

LUCID[®] has so many features that you will say "this is what I need in a spreadsheet", such as automatic prompting of an incorrectly typed-in formula showing just where the mistake was made.

LUCID[®] has expanded "go to" functions that remember and produce a windowing capability.

But perhaps most remarkable is that LUCID[®] is not only a spreadsheet but a program generator as well. First, LUCID[®] lets you protect all cells against entry or change, and then unprotect just the cells you want for someone else to use as input fields.

LUCID[®] will not only process values, but text input as well so that the facts other than numbers can be responded to. LUCID[®] has the ability for you to refer in a formula to cells containing words. This feature combines with the capacity of doing "if then" statements that work by doing table look-ups against even massive X/Y charts of text or numerical information. You can produce a program that responds to inputs with no programming knowledge whatsoever.

You can prepare a report section in your spreadsheet with instructions to your user for printout, and they can produce a personalized printout that responds to their input. All your formulas and tables that did the calculations and provided the facts are invisible to that user. LUCID[®] is useful for doctors for patient questionnaires, troubleshooting technicians, purchase clerks, people doing job quotes, stores for customer workups, insurance agents and anybody who needs to process specific facts and numbers to produce a report based on those responses.

LUCID[®] comes with a manual that explains not only the characteristics of LUCID[®], but will train you how to use a spreadsheet even if you have never seen one before. You are shown how to do budgets, forecasts, breakeven analysis amortizations and many other types of personal and business reports and calculations.

User friendly is such an over-used term in this industry, but a typical comment has been "I have never seen a spreadsheet that does so much, and yet LUCID[®] is so much

easier and faster to use."

LUCID[®] is a result of a most exhaustive developmental effort in which PCSG's objective was to develop a spreadsheet that was better than the state-of-the-art. We are so pleased because LUCID[®] provides for the Model 100 spreadsheet capability you cannot equal on a desktop computer.

LUCID[®] is, in our opinion and that of those who have examined it, a breakthrough. We sell it on a 30 day trial. If you are not completely satisfied, return it within 30 days for a full refund. Priced at \$99.95 on snap-in ROM. Please add \$5.00 for shipping and handling. Mastercard, Visa, American Express or C.O.D.
©PCSG 1984,1991

Distributed by:

**Tri-Mike
Network
East**

1 (603) 588-2010

**P.O. Box 372,
Peterborough, NH 03458**

Text processing power that no other program can equal.

NOW
AVAILABLE
ON
M-200!

Write ROM[®]

on Snap-in Cartridge \$99.95

(please add \$5.00 shipping and handling charge to your order)

TMNE says "Send it back in 30 days for a full refund if you don't agree."

WRITE ROM is the definitive word processing extension for the Model 100. PCSCG produced the first text formatter for the Model 100, now sold by Radio Shack as Scripsit 100. Now, 18 months later, PCSCG introduced WRITE ROM. Those who have experienced it say WRITE ROM literally doubles the power of the Model 100.

WRITE ROM — as its name implies — is on a snap-in ROM. You simply open the little compartment on the back of the Model 100 with a quarter and press WRITE ROM in. It's as easy as an Atari game cartridge. You can use other ROM programs like Lucid whenever you wish.

WRITE ROM lets you do every formatting function you'd expect, like setting margins, centering, right justifying and creating headers and footers. But it does them under function key control.

WRITE ROM remembers your favorite format settings so you can print a document without any setup, but you can change any formatting or printing parameter instantly with a function key.

WRITE ROM's "pixel mapping" feature shows you an instant picture on the screen of how your printout will look on paper.

In all there are 64 separate features and functions you can do with WRITE ROM, and some of these features are truly breakthroughs for the Model 100.

First, WRITE ROM lets you do search and replace. Any word or phrase in a document can be searched for and replaced with any other phrase where the search words appear.

Second, WRITE ROM lets you send any text (formatted or not) to any other computer over the phone with just a function key. What's more, it dials and handles sign-on and sign-off protocol automatically.

Third, WRITE ROM has a wonderful feature called Library that lets you record favorite phrases, words or commonly used expressions (often called boilerplate).

Any place you wish Library text to appear you just type a code. WRITE ROM automatically inserts the text just like a Xerox Memory Writer. Picture what you can do with that kind of capability.

WRITE ROM is blindingly fast. No one can claim faster operation. Because it is on ROM it uses virtually none of your precious RAM. It works with any printer, serial or parallel. You can make a duplicate copy of a document file under a new filename. Rename or delete (kill) any RAM file with function key ease.

This description only scratches the surface of this amazingly powerful piece of software. Dot commands allow control of such things as margins, centering, line spacing and other changes in the middle of a document. Most are WordStar™ compatible.

A mailmerge feature allows you to send the same document to every name on your mailing list, personalized for each recipient.

WRITE ROM enables you to do underlining, boldface and correspondence mode as well as any other font feature like superscripts that your printer supports, in a way that many users say "is worth the price of the program."

To underline you don't have to remember a complicated printer code. You just type CODE u, and to stop underline, CODE u again. The CODE key is to the right of your spacebar. Boldface? CODE b to start and stop. Easy to remember and do. Five different printer features of your choice.

We couldn't list all the features here. For example, you can select not just double space but triple or any other. You can use your TAB

key in a document. WRITE ROM allows you to indent. This means you can have paragraphs with a first line projecting to the left of the rest of the paragraph. WRITE ROM has a feature unique for any word processor on any computer. It's called FORM. FORM is an interactive mechanism that lets you create ooooon prompts so that you or someone else can answer them to fill out forms or questionnaires.

With FORM, any place that you had previously typed a GRAPH T and a prompt in a document, WRITE ROM will stop and show you that prompt on the screen. You can type in directly on the screen and when you press F8 you see the next prompt. It goes to a printer or a RAM file.

Think how you can use FORM. A doctor or nurse could use it for a patient's history with each question appearing on the screen. An insurance salesman could use it for his entire questionnaire. You could construct a series of prompts to answer correspondence, typing the answers, even using Library codes. This feature lets you answer letters in rapid-fire fashion, each with personalized or standard responses.

Before WRITE ROM you had to be a programmer to create a series of prompts. Now it's as simple as GRAPH T.

PCSCG makes the claim that WRITE ROM is the easiest, fastest and most feature-rich formatter for the Model 100. We're happy to offer WRITE ROM because it expands the 100 to a dimension of text processing you cannot equal on even larger computers.

We brashly state that WRITE ROM is the best you can buy. But put that to the test. If you aren't as excited as we are, return it for a full refund. Priced at \$99.95 on snap-in ROM. Mastercard, Visa, American Express and COD. Please add \$5.00 shipping and handling charge.

Distributed by:

Tri-Mike Network East

P.O. Box 372, Peterborough, NH 03458

1 (603)

588-2010

VISA / MASTER CARD / AM. EXP. / C.O.D.

Another fine product from the innovative people at PCSCG!

Cut the Glare with KANTEK screens

Computer users frequently complain about the difficulty in viewing their computer screens. One of the best ways to solve this problem is with an anti-glare screen. But where do you find one to fit your particular monitor? Try KANTEK, Inc., who has just introduced a new line called Spectrum-Universal.

Designed to fit most 12- to 15-inch PC monitors, Spectrum-Universal Anti-Glare screens are constructed of optically pure glass with multiple anti-reflective coating on both sides, substantially reducing glare and reflections by up to 99%. The screens improve screen resolution and contrast, install in seconds (no tools required) and lift up for

easy cleaning.

The Spectrum-Universal, Anti-Static, Anti-Radiation Screen features a conductive coating and a grounding cord, and blocks up to 98% of ELF/VLF E-field radiation, reduces UVA/UVB radiation, eliminates static, and complies with Swedish and E.C. standards.

Suggested retail price for the Anti-Glare screen is \$74; the suggested retail price for the Anti-Radiation screen is \$119.

Contact: KANTEK, Inc., 15 East Main St., East Rockaway, NY 11518. (516)593-3212, fax (516) 593-3295. Or circle 64 on the reader service card.

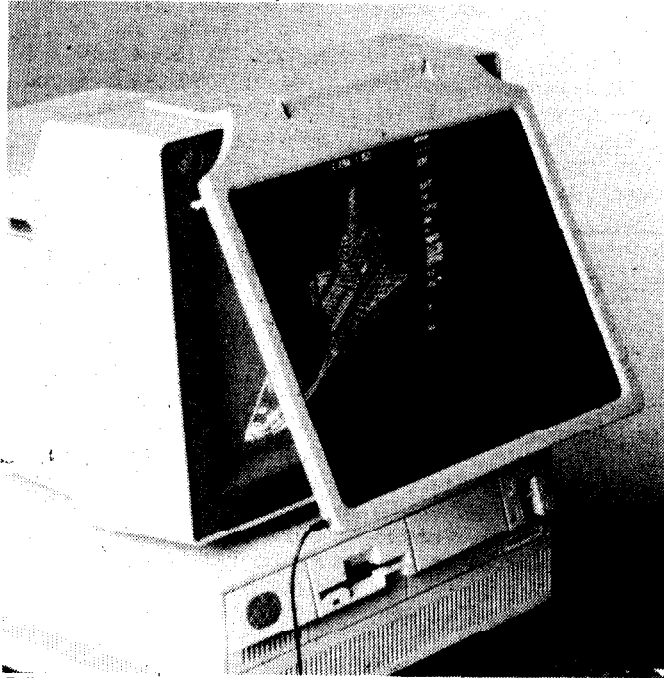

Relieve eyestrain with the Spectrum Universal Anti-Glare Screen from KANTEK.

Citibank's Global Report now on CompuServe

Current, detailed information on the global financial market is now available to individual investors through the CompuServe Information Service. Global Report, a service of Citibank, provides CompuServe members with real-time foreign exchange and fixed income rates from major worldwide markets; worldwide political and financial news; in-depth company and industry profiles; country profiles;

and information on stocks, bonds, commodities and other markets.

Updated around the clock, the information in Global Report is supplied by more than a dozen international sources and provides a comprehensive view of the global marketplace. Rate screens are updated dynamically, such as those showing foreign exchange rates, allowing the member to watch price and rate changes as they occur.

1st Act! now included with Selko's Data Directory

Buyers of Selko's hand-held Data Directory will now be able to manage their business relationships, time and information more effectively away from the office. *1st Act!*, the popular contact management and day planning software, is now being included with Selko's electronic rolodex.

1st Act! integrates a contact database and calendar manager, pre-defined report generator, and a word-processor which produces form-letters and other documents quickly and easily. Other features

include an automatically-generated history for each contact, quick search capability and an auto-dialer.

The Selko **Data Directory** is a hand-held electronic organizer that fits in the user's pocket. It's an ideal way to carry important names, addresses and phone numbers.

1st Act! and the Selko **Data Directory** will be available through Computer City and other retail channels for a suggested retail price of \$199. *1st Act!* retails for \$79.95. Or circle 65 on the reader service card.

Congratulations Laser Paper from MicroFormat

Micro Format's newest computer paper is the **Congratulations "Designer Series" Computer Paper**.

Available in either blue or brown, this unique laser paper design is suitable for letters, certificates and awards. "**Congratulations**" features an **Ambigram chain** designed by artist John Langdon.

In his book "**Word-play**," Mr. Langdon defines **Ambigrams** as "... words that can be read in more than one way or from more than a single vantage point."

Congratulations, with its unique ambigram design, can be read right-side-up and up-side-down. Thus it can also be used in either Portrait (vertical) or Landscape (horizontal) mode.

Congratulations Laser Paper is printed with special high-temperature heat resistant inks designed for

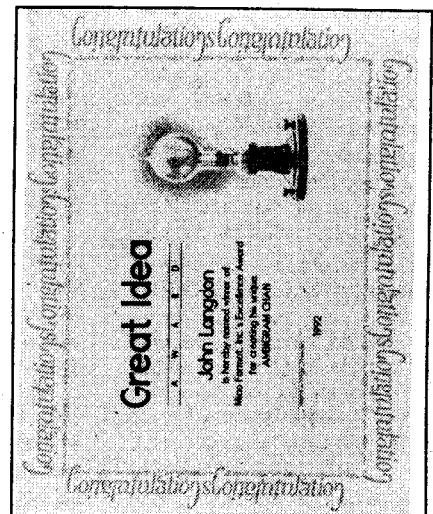

Congratulations Laser paper from BANNER BAND.

use in desk-top laser printers as well as in photo copiers.

For the name of a BANNER BAND Computer Paper Product distributor in your area, call BANNER BAND toll free at 1-800-333-0549. Or circle 66 on the reader service card.

A feature called "Autosearch" allows Global Report users to customize the way they access information by retrieving regularly-viewed pages with a single command.

Global Report carries a connect surcharge of \$35 per hour, or approximately 59 cents per minute. This is in addition to CompuServe's

standard connect charge of \$12.80 per hour for modem access at 1200 or 2400 bits per second.

Contact: Debra Young, CompuServe Incorporated, 5000 Arlington Centre Blvd., Columbus, OH 43220 (614)457-8600, CompuServe Mail: 70004.336. Or circle 67 on reader service card.

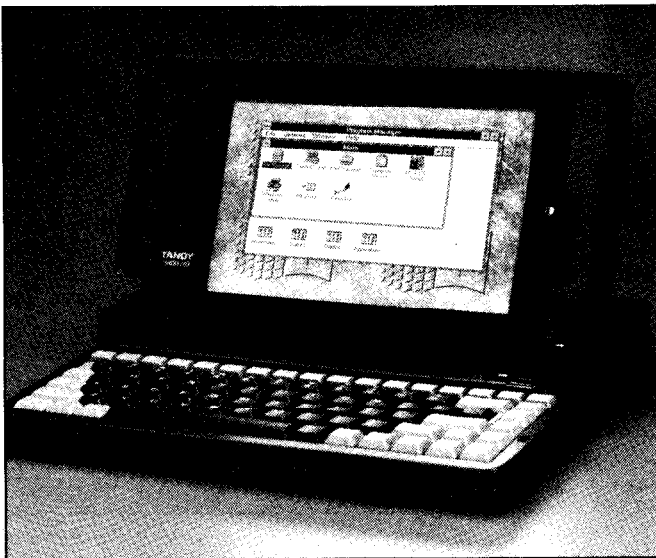

Tandy's new 3800 HD.

New Tandy 3800 Notebook PC

Tandy's new 3800 HD notebook computer is the first PC manufactured by Tandy Corporation which features a high-performance, low-power Cx486SLC microprocessor from Cyrix Corporation. The 3800 HD uses the 20 megahertz (MHz) version of the Cx486SLC chip, giving consumers high-performance portability at an affordable price of \$1,999.

The Tandy 3800 HD measures 1.7 x 12.2 x 10 inches and weighs approximately six pounds with its battery. Standard features include two megabytes of memory, one 3.5 inch 1.44 MB floppy disk drive, an internal 19-millisecond 60 MB hard drive, a full-size 84-key keyboard, 640 x 480 VGA graphics support, a 9-inch diagonal edgelit liquid crystal display with 32 gray scales, one serial port and one parallel/external floppy disk drive port.

Memory can be expanded to 4 MB. An optional math coprocessor and an optional 2400 bps/9600 send/receive fax modem can also

be installed for added performance.

The 3800 HD is powered by a rechargeable Ni-Cad battery which provides power for approximately two hours and can be fast-charged in two hours using the standard 110V AC adapter.

The MS-DOS 5.0 operating systems, Microsoft Windows 3.1, Microsoft QBasic, Microsoft Shell and America Online software programs are pre-installed for added value.

Optional accessories include a 2MB memory upgrade, internal 2400bps/9600 send/receive fax modem, replacement battery, external battery charger, and fabric or leather carrying cases.

The 3800 HD carries a one-year limited warranty and is available at Radio Shack stores and dealers nationwide.

Contact: Fran McGehee, Radio Shack, 700 One Tandy Center, Fort Worth, TX 76102. (817)390-3487. Or circle 68 on reader service card.

Bitnet for VMS users

For new and seasoned users alike, **Bitnet for VMS Users** is the first book to cover BITNET exclusively. Beginning with the history of BITNET, the text details many aspects, from electronic mail to searching remote databases to carrying on RELAY conversations with other users around the world.

Available from Digital Press,

Bitnet for VMS Users has a suggested retail price of \$25.95. ISBN number 0-13-928797-3.

Contact: Monica Broadnax, Publicist, Digital Press, One Burlington Woods Drive, Burlington, MA 01803. (617) 273-6508, fax (617)273-6522. Or circle 70 on reader service card.

Fortress UPS Protects your system

Protect your system from power fluctuations with an uninterruptible power system (UPS). *Fortress UPS* is a light, inexpensive UPS that offers true no-break power protections and programmable microprocessor control.

Fortress allows no breaks in output power, regardless of what happens to the input power. Other standby systems must break their output power whenever they switch to inverter.

Fortress includes the following features:

- **Automatic Battery Replacement Warning**
- **Lightning and Surge Protection**
- **Digital Parameter Displays** — including such features as Voltage In, Voltage Out, Battery Voltage, Percent Loading, Alarms.
- **15 Programmable Parameters and Alarms** — Low Backup Time, Overload, Replace Battery, High Temperature, Low Battery and Site Wiring Fault.

- **Smart Communications Port** — *Fortress* can communicate with your computer terminal, or remote alarm devices.

- **Shutdown Interface Kits** — *Fortress* can interface with Novell and other LANS, DOS, UNIX, XENIX, OS/2 and IBM AS/400 systems, and many others.

Fortress carries a warranty for one full year, parts and factory service and a Double Lifetime Warranty on lightning and surge suppression.

Fortress is available in several configurations, from capacities ranging from 360/220 (VA/Watts) to 2000/1500. Pricing is dependent upon configuration, and ranges from \$599 to \$2,099.

Contact: Dwight Quaschnick, Technical Sales Coordinator, BEST Power Technology, P.O. Box 11, Necedah, WI 54646. (800)356-5794, (608)565-7200, fax (608)565-2221. Or circle 69 on the reader service card.

Access your remote office host PC

Do you need to access your office PC while you're on the road but you hate to leave the power on continuously? Well, Server Technology has a product that's right for you.

Called *Remote Power On/Off*, the product works as follows:

Power On/Off sits in-line between the phone outlet and the remote host PC's modem. It monitors standard telephone line RING and ON-HOOK signals.

RING — *Power On/Off* detects this signal on incoming calls. When a selectable ring number is reached, *Power On/Off* activates power to the host PC. During the power-up process the host PC's AUTOEXEC.BAT files then loads the appropriate communication or remote control software.

ON-HOOK — *Power On/Off* detects this signal when the call

completes. After a programmable delay, it powers off all hardware devices under its control.

Power On/Off is fully compatible with all standard internal or external modems, communication software and remote control applications such as *pcANYWHERE*, *Carbon Copy*, *Commute*, *ProCOMM*, *LapLink Pro*, *Crosstalk*, and others. It can be used with any IBM/Compatible, Macintosh, or UNIX PC.

The *Remote Power On/Off* unit, complete with a companion Intelligent Power Module and cables costs \$169.95 and is available from Server Technology by calling (800)835-1515 or (408)988-0142.

Contact: Brandon Ewing, Server Technology, 2332-B Walsh Avenue, Santa Clara, CA 95051. (408)988-0142, fax (408)988-0992. Or circle 71 on reader service card.

Did you hear about the programmer who got stuck in the shower?

His shampoo's instructions read "Lather, rinse, repeat."

And do you know how many programmers it takes to change a lightbulb?

That's a hardware problem!



The Portable 100 Classifieds

SOFTWARE

FAST (tm) 3x turbo cassette LOAD/SAVE utility for Tandy M100/102, M200 (specify). See 11/89 P100 review. SASE for information. Cassette, manual \$19.95 ppd. **Zwillenberg**, 475 Richmond, Maplewood, NJ 07040

HARDWARE

Model 100 32K with Super Rom \$275.00 firm. Call (308)527-3506.

Model 200 48, Super ROM, includes all documentation, technical manual, cables; \$285.00; Chipmunk Drive; \$115.00. Both for \$360. (215)678-6972. 9/92

Tandy 102 32K, Portable Disk Drive & portable Brother printer \$350.00; Tandy 1100FD 640K and modem \$450.00. (213)828-1997.

TRS-80 Model 100 32K, Super ROM, case, legs, adapter, seven software packages.

books. Needs new LCD screen. \$199.00. Peirce, 2948 Blairstone Ct., Tallahassee FL 32301.

Portable 100 back issues, from 1983 to November 1992, 68 issues total, for only \$129.95. That's less than \$2 per issue! For those who purchased the 99.95 special package previously advertised, get the issues from Summer 1989 to November 1992 for only \$30.00! Free shipping to US addresses. Portable 100, P.O. Box 428, Peterborough, NH 03458, (603) 924-9455. MC, Visa, Amex accepted.

Record voltage or other analog parameters with your 100/102/200. DATAMITE A/D converter connects to cassette jack, software provides voltage readout and/or emulates scrolling chart recorder on your Tandy screen. \$66 + \$4 S&H: Jones Service & Design, 1842 S. Nugent Rd., Lummi Is., WA 98262. (206)758-7258.

Tandy 100, 32K,PDD, DMP-130 printer, software, cables, manuals. \$375. (312-644-0638 6/92

FOR SALE

TRS-80 Model 100, includes VDI w/TWO 5.25" drives, HARD carrying case, MOST accessories, plus Amber monitor, VGC; package only. Excellent condition. Best offer (708) 837-8741. 7/92

Tandy 200 with disk video interface, Tandy software, modem cable, cassette cable, cassette player, and computer adapter. \$250. Linda (717) 566-5411. 6/92

Olivetti PR2300 Printer, works well with Model 100, \$40. plus shipping. Robinson (413) 545-1591 9/92

Model 100 32K, Super ROM, 2 A/C adapters, printer cable, and modem adapter. Cassette, A/C adapter and two cables. Manuals, books, taped programs, program listings. \$400.00 Chris Lothian (612) 425-1340 after 18:00 CDT. 9/92

HOW TO PLACE A CLASSIFIED AD

Categorize your advertisement (Hardware, Software, Services, Wanted, Etc.) and carefully type your message. We are not responsible for correctly interpreting handwritten advertisements. Phone numbers, street numbers, dimensions, and any abbreviations count as one word. Logos, company or product, are not allowed, neither are display advertisements. Business rates are 90¢ per word; non-business rates (individuals advertising) are 60¢ per word. Add up the cost and send the advertisement copy with a check, money order, Visa, or Mastercard number to: Portable 100 Classifieds, 145 Grove St. Ext., P.O. Box 428, Peterborough, NH 03458-0428, c/o Linda Tiernan. Make checks payable to Portable 100 Classifieds. Include your complete return address and phone number (phone number is printed only if it is included in the advertisement itself). Materials due the 1st of the month, two months prior to the magazine cover date (example: materials for the February issue must be received by December 1st.) Advertisements received after the deadline will appear in the next scheduled issue. Payment must accompany order. No refunds for advertisements that miss deadlines, regardless of reason. We reserve the right to change advertisement categories, and to reject, edit, or cancel any advertisement we deem improper. There are no agency discounts for classifieds. For faster service call 603-924-9455.

102 32K, PDD2, Super ROM installed; Scripsit and Interactive Solutions (not installed); null modem; plastic hard cover; CCR-82; Kyotronic 85; cables; adapters; all manuals, many, many books; Silver Reed 500, Epson RX-80 & LQ500 printers; ribbons; Brother EP20 portable thermal typewriter; ribbons; thermal paper; Kaypro 2 (CP/M) computer. Send for price list Box G, NY, NY 10159-1056; 212 689-0772; FAX 212 481-0552 7/92

Two Model 100's with ROMS. One 100K FDD Acoustic Coupler and assorted software. Call or write for description and price.. Like new. PO Box 3104 Mankato, MN 56001 (507) 726-2704

WANTED

WANTED, NEC PC-8300's like new or good condition only. (216) 531-2185, ext. 12. 6/93

Ad Category _____ No. of words x (90¢)(60¢) _____ #Issues to run _____
 Name _____
 Address _____
 City _____ State _____ Zip _____
 Total Enclosed x (Ad Cost x Issues) _____ Phone Number _____
 Visa/Mastercard Number _____ Exp. Date _____
 Signature _____

New LOW Rates!

Businesses—90¢ per word
 Non-business --60¢ per word
 Find those items you need, sell the ones you don't. start a business inexpensively!

ADVERTISER'S INDEX

Free Information

For free information on products advertised in this issue of *Portable 100*, locate the Reader Service number corresponding to the advertisement that interests you. Circle the number on the Reader Service Card at page 23 (or on the protective mailing wrapper if you are a subscriber) and drop it into the mail. The literature you've requested will be forwarded to you without any obligation. Please allow 3-5 weeks for delivery.

ADVERTISERS

RS#		Page
09	ADPI	3
34	Anvil Cases	36
165	Club 100: A Model 100 User Group	1
178	Club 100: A Model 100 User Group	CIII
154	Computer Reset	8
88	EME Systems	CII
85	EME Systems	17
81	EME Systems	26
83	EME Systems	26
35	Geokon	6
116	King Computer Services	32
149	MicroMime	12
37	MicroMime	32
45	Pacific Computer Exchange	6
172	Pacific Computer Exchange	6
121	Paul Globman	8
117	Portable 100—Gender Changer	10
55	Purple Computing	10

ADVERTISERS

RS#		Page
127	Software Versand	32
20	System Peripheral Consultants	10
133	Trantor	12
71	Tri-Mike Network East-WR	40
73	Tri-Mike Network East-D+	16
75	Tri-Mike Network East-CR	29
74	Tri-Mike Network East-Lucid	39
72	Tri-Mike Network East-SR	CIV
134	Ultrasoft Innovations	23

New Products

62	AddStor, Inc.	38
66	Banner Band	41
69	BEST Power Technology	42
67	CompuServe	41
70	Digital Press	42
65	1st Act!	41
64	Kantek, Inc.	41
61	MicroComputer Accessories	38
63	Que	38
68	Radio Shack	42
71	Server Technology	42

44 PORTABLE 100 Back Issues for only \$99.95!

Now you can buy all 44 available back issues covering **September 1983 to Summer 1989** for the bargain basement price of only **\$99.95!**

Call **603-924-9455** and ask for the **Portable 100 Back Issue Special**. Or write to Portable 100, POB 428, Peterborough, NH 03458-0428, and enclose your payment (Check, M.O., MasterCard, Visa, or AMEX numbers). U.S. shipping and handling included. Foreign shipping is \$20 more, surface only. **Order now! Supplies are limited!**

FINGERS TIRED?

Accomplish more... in less time.
Get the P100-To-Go program disk.

Make your life easier! Save hours of time from typing in lengthy programs. Never worry again about typing errors. Have more fun with *Portable 100's* new disk-of-the-month service. Every program from the magazine is included on each month's disk. No typing. No trouble.

We make it easy and inexpensive. You deserve value. At *Portable 100* we believe in value. That's why we're not only making each month's programs available on 100K Tandy Portable Disk Drive disks (which work in 200K drives), we're also



making sure any extra room on each disk is packed with interesting and fun bonus programs. All files are in .DO format. Ready to load. Ready to go.

Not just for the Tandy 100. The P100-To-Go disks will work with any computer that uses the Tandy Portable Disk Drive, the Brother FB100, and the Purple Computing Portable Disk Drive. This means your NEC-8201/8300, Tandy 100/102, Tandy 200, Olivetti M10, and Kyotronic KC-85 can all load these programs into memory (once loaded, changes for specific computer models may be required, refer to corresponding program article for information about compatibility with particular computers).

Subscribe and save! You can order P100-To-Go disks individually at only \$9.95, but for maximum savings sign up for our **Six-pack Special**, one disk each month

- Yes!** Save me hours of typing time. Sign me up for your **Six-pack Special** (6 monthly disks of the *Portable 100* programs, plus the special bonus programs included with every disk) for only \$47.70.
- P100-To-Go 1988 disk set (Jun.-Dec. 1988) \$47.70.
- P100-To-Go 1989 disk set A (Jan.-Jun. 1989) \$47.70.
- P100-To-Go 1989 disk set B (Summer '89.-Feb. 1990) \$47.70.

Individual P100-To-Go disks at \$9.95

- Jun '88 Jan '89 Sum '89 Mar '90 Apr '91
- Jul/Aug '88 Feb '89 Oct '89 Apr '90 May '91
- Sep '88 Mar '89 Nov '89 May '90 Jun '91
- Oct '88 Apr '89 Dec '89 Nov. '90 Jul/Aug '91
- Nov '88 May '89 Jan '90 Dec. '90 Sep '91
- Dec '88 Jun '89 Feb '90 Mar. '91 Oct '91

To place your order immediately, call:

603-924-9455

Prices include postage and handling. Please allow 4-6 weeks for delivery. Foreign airmail add \$2 per disk. All foreign, US Funds drawn on US banks only.

- Payment enclosed (check or money order)
- MasterCard VISA Amex

CARD NUMBER _____ EXP. DATE _____

SIGNATURE _____

NAME _____

STREET ADDRESS _____

CITY _____

STATE _____

ZIP _____

Mail to: Portable 100, P100-To-Go,
P.O. Box 428, Peterborough, NH 03458-0428



Rick announces more nifty new stuff and some totally excellent killer deals...

RAMPAC is now manufactured by EME Systems and Club 100. 256K storage for Model 102 or 200. Light weight and small. Plugs into system bus. Access via built in software. Note: rampac combined with extRAM or XR4 allows for super fast ROM swaps. \$179 + \$5 s&h

New: Model 100 to RAMPAC cable allows Model 100 users to attach and use RAMPAC - \$20 + \$2 s&h

Alert!! Rick finds giant stash of computer-stuff in West coast warehouse: Model 102's 32K \$255 / Model 100's 32K \$195 / NEC 8201 16K \$85 / WP2's \$165 / Model 105 printers \$55 (\$10 s&h on equipment)

Booster Pak is back!!! Start at 96K and expand to 1 meg. Add ROM's for easy ROM swapping. Built in TS-DOS. Includes direct access BASIC commands for large database applications. Attaches to bottom of Model 100 or 102. \$299 + \$6 s&h

Tons Of Programs: What's in the Club 100 online public domain library? Order a "Online Library Catalog Listing Update" disk and find out. \$5 (state tpdd, tpdd2, MSDOS 5.25 or 3.5 format). New, BBS Guide/Tutorial... \$10

We've got EVERYTHING!!!
ROM's, RAM (we'll match or beat almost any RAM price - CALL), cables, information, free online classified advertising (buy, sell and wanted laptop stuff), e-mail, used stuff, books, how-to's, technical references, and just about everything you're looking for.

Facts: Nostalgic computing is alive and well as folks rediscover the value and fun of inexpensive, capable Model T computers. Each week we field over 1000 voice, e-mail and faxes from new and old laptop owners. There's over two million Model 100, 102, 200, WP2 and NEC 8201 owners in the world. The Model T's attributes (i.e., built in programs, long battery life, light weight, data compatibility) offer most of what folks want in a laptop computer, today.

More facts: Most folks use their laptop for word processing. About 20% use telcom. Very few others use spreadsheets, database, or public domain programs, but interest in expanding Model T computing is growing. Club 100 has the information and items to help you get more out of your laptop. Call Club 100 and discover what you're missing. Get on our mailing list and receive a free catalog.

HELP: Due to overwhelming interest vs. limited staffing and time, we find it almost impossible to respond to paper mail in a timely fashion; except for catalog requests. Voice, electronic, and fax mail is your best bet for feedback and assistance.

Club 100: A Model 100 User Group
Model 100/102/200/WP2 & NEC8201 Support.
P. O. Box 23438
Pleasant Hill, CA 94523

510-932-8856 voice
510-937-5039 fax
510-939-1246 bbs

Thanks... -Rick-

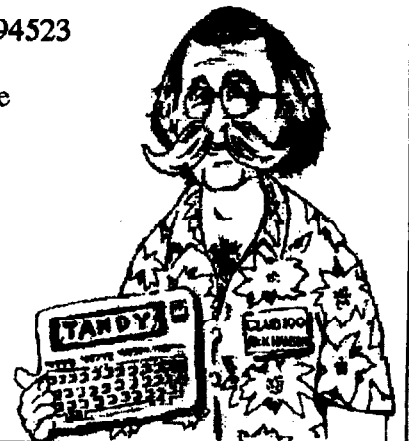

SUPER ROM

Lucid Spreadsheet Write ROM Database Outliner

Boots
the Tandy
Portable Drive
with one
button!

Now
Available
for the
Model
200!



NOW YOU CAN REALLY HAVE IT ALL!

All on one ROM. Truly the finest four programs available for the Model 100 — guaranteed. Try it for 30 days. If you aren't blown away by the excellence return it for a full refund.

\$199⁹⁵

(Please add \$5.00 shipping & handling)

The four best programs for the Model 100 all on one ROM. 32K of power without using any RAM for program storage. This is the PCSG Snap-In ROM that just presses easily into the little ROM socket in the compartment on the back. You access the four right from the main menu like built-ins.

Write ROM — the definitive word processor for the Model 100. Function key formatting or dot commands. Search and replace. Library feature — inserts words, phrases or whole documents into text from just a code. MAP lets you see a picture of your document. In all there are 60 features and functions. No one can claim faster operation. FORM lets you create interactive forms with on-screen prompts that you can answer from the keyboard. Nothing else for the Model 100 compares with the features of Write ROM. Exactly the same as the Write ROM sold as a single program. Infoworld says it "makes the Model 100 a viable writing unit ... sur-

passed our highest expectations for quality and clarity."

Lucid Spreadsheet. This is the one PICO magazine says "blows Multiplan right out of the socket" and Infoworld performance rated as "excellent" and said "makes the Model 100 compute." Gives you features you cannot get with Lotus 123. Lets you build spreadsheets in your Model 100 that would consume 140-150K on a desktop. Program generating capability with no programming knowledge required. Variable column widths. Includes find and sort with function key control. It's fast, recalculates like lightning. No feature has been taken from the original, only new ones added.

Database: This is a relational data base like no other. You can do everything from mailing lists to invoices. No complicated pseudo-coding, you create input screens as simply as typing into TEXT. You are not limited by size; you can have as large an input screen as you wish. Prints out reports or forms, getting information from as many files as

you like. Complete math between fields. Total interface with Lucid worksheets.

Outliner: Does everything that Think-tank does on a PC but a whole lot better. Includes a Sort for your headlines. Lets you have headlines of up to 240 characters. Has cloning, hoisting and sideways scroll up to 250 characters. Like Lucid, this one sets a new standard for outliners. This is the way to plan and organize your projects.

Present Lucid and Write ROM owners can upgrade for \$150. If you have both it's \$125.

As usual PCSG sells the Super ROM on a thirty day guarantee. If for any reason you are not satisfied, simply return it for a full refund.

We are excited about this product. Super ROM gives the Model 100 the true power of a desktop. No other multi-program ROM has software that compares. But don't take our word for it. We invite you to make that comparison yourself. Priced at \$199.95 on Snap-In ROM.

Another fine product
from the innovative people at PCSG!

Got stuck with somebody else's multi-ROM?
We'll upgrade it for \$150.

Distributed by:

Tri-Mike Network East

P.O. Box 372, Peterborough, NH 03458 • 1 (603) 588-2010

© PCSG

MC, Visa, American Express, Check, or C.O.D.

Circle 72 on reader service card.