HP OmniBook 4100/4150



Service Manual

Notice

In a continuing effort to improve the quality of our products, technical and environmental information in this document is subject to change without notice.

This manual and any examples contained herein are provided “as is” and are subject to change without notice. Hewlett-Packard Company makes no warranty of any kind with regard to this manual, including, but not limited to, the implied warranties of merchantability and fitness for a particular purpose. Hewlett-Packard Co. shall not be liable for any errors or for incidental or consequential damages in connection with the furnishing, performance, or use of this manual or the examples herein.

Consumer transactions in Australia and the United Kingdom: The above disclaimers and limitations shall not apply to Consumer transactions in Australia and the United Kingdom and shall not affect the statutory rights of Consumers.

© Copyright Hewlett-Packard Company 1998, 1999. All rights reserved. Reproduction, adaptation, or translation of this manual is prohibited without prior written permission of Hewlett-Packard Company, except as allowed under the copyright laws.

The programs that control this product are copyrighted and all rights are reserved. Reproduction, adaptation, or translation of those programs without prior written permission of Hewlett-Packard Co. is also prohibited.

Portions of the programs that control this product may also be copyrighted by Microsoft Corporation, SystemSoft Corp., Crystal Semiconductor Corporation, Phoenix Technologies, Ltd., ATI Technologies Inc., and NeoMagic, Inc. See the individual programs for additional copyright notices.

Microsoft, MS, MS-DOS, Windows and Windows NT are registered trademarks of Microsoft Corporation. Pentium and the Intel Inside logo are U.S. registered trademarks and MMX is a U.S. trademark of Intel Corporation. TrackPoint is a U.S. registered trademark of International Business Machines.

All certifications may not be completed at product introduction. Check with your HP reseller for certification status.

This equipment is subject to FCC rules. It will comply with the appropriate FCC rules before final delivery to the buyer.

Hewlett-Packard Company
Mobile Computing Division
19310 Pruneridge Ave.
Cupertino, CA 95014, U.S.A.

Edition History

Edition 1 April 1998
Edition 2 October 1998
Edition 3 January 1999
Edition 4 September 1999

Contents

1.

Product Information	1-1
Features and Operation	1-3
Turning the OmniBook On and Off.....	1-4
Checking the Status of the OmniBook.....	1-5
Using Fn Hot Keys.....	1-6
Resetting the OmniBook.....	1-6
System Resources	1-7
Specifications.....	1-9
Internal Design.....	1-14
Removal and Replacement	2-1
Removing the Battery or Plug-In Module (User-Replaceable).....	2-3
Removing a RAM Board (User-Replaceable).....	2-4
Removing the Hard Disk Drive (User-Replaceable)	2-5
Replacing Small Parts (User-Replaceable).....	2-8
Removing the Keyboard (HP Authorized Service Providers Only)	2-9
Removing the Display Assembly (HP Authorized Service Providers Only).....	2-11
Removing the LCD Module (HP Authorized Service Providers Only).....	2-13
Removing the Top Case (HP Authorized Service Providers Only).....	2-16
Removing the CPU Module (HP Authorized Service Providers Only).....	2-19
Removing the Motherboard or Bottom Case (HP Authorized Service Providers Only)	2-24
Removing or Repairing the BIOS IC (HP Authorized Service Providers Only).....	2-29
Removing Other Components (HP Authorized Service Providers Only).....	2-31
Troubleshooting and Diagnostics.....	3-1
Troubleshooting	3-2
Troubleshooting the Problem.....	3-2
Verifying the Repair	3-3
Suggestions for Troubleshooting	3-4
Diagnostic Tools.....	3-13
OmniBook Diagnostic Program.....	3-13
Power-On Self-Test	3-20
Sycard PCCtest 450 CardBus Card (Optional).....	3-23
Desktop Management Interface (DMI).....	3-24
BIOS Setup Utility.....	3-26
Replaceable Parts	4-1
Reference Information	5-1
Password Removal Policy	5-1
Hewlett-Packard Display Quality Statement	5-2
Service Notes and Obsolete Parts	5-6

Figures

Figure 1-1. OmniBook - Front View	1-3
Figure 1-2. OmniBook - Side View	1-3
Figure 1-3. OmniBook - Rear View	1-4
Figure 1-4. Replaceable Module Diagram	1-14
Figure 2-1. Removing the Battery or Plug-In Module.....	2-3
Figure 2-2. Removing a RAM Board.....	2-4
Figure 2-3. Removing the Hard Disk Drive	2-5
Figure 2-4. Installing a Hard Drive in the Cover.....	2-6
Figure 2-5. Removing the Keyboard	2-9
Figure 2-6. Removing the Display	2-11
Figure 2-7. Removing the LCD Module	2-15
Figure 2-8. Removing the Top Case.....	2-17
Figure 2-9. Removing the CPU (OmniBook 4150†).....	2-21
Figure 2-10. Inserting the CPU (OmniBook 4100/4150†).....	2-22
Figure 2-11. Positioning Thermal Pads	2-23
Figure 2-12. Removing the Motherboard	2-26
Figure 2-13. Installing Docking Doors and Module Latch.....	2-28
Figure 2-14. Example of Serial Number Label	2-28
Figure 2-15. Removing the BIOS IC.....	2-29
Figure 2-16. Boot-Block Jumper.....	2-31
Figure 3-1. Basic Troubleshooting Steps	3-2
Figure 3-2. OmniBook Diagnostic Screens — Basic and Advanced.....	3-13
Figure 3-3. Serial and Parallel Loopback Connectors.....	3-15
Figure 4-1. Exploded View	4-2
Figure 4-2. Display Components.....	4-7
Figure 4-3. Motherboard Components	4-8

Tables

Table 1-1. Product Comparisons.....	1-1
Table 1-2. OmniBook 4100/4150 Series Models.....	1-2
Table 1-3. Activating Power Modes.....	1-4
Table 1-4. Main Status Lights (LED Strip Cable).....	1-5
Table 1-5. Keyboard Status Lights (VGA PCA or Motherboard).....	1-5
Table 1-6. Fn Hot Keys	1-6
Table 1-7. System Interrupts	1-7
Table 1-8. System Memory	1-7
Table 1-9. System Input/Output Addresses (100-3FF).....	1-8
Table 1-10. DMA Channels	1-8
Table 1-11. OmniBook 4100/4150 Series Specifications	1-9
Table 1-12. OmniBook 4100/4150 Series Accessories.....	1-12
Table 1-13. Functional Structure.....	1-15
Table 2-1. Removal Cross-Reference.....	2-1
Table 2-2. Required Equipment	2-2
Table 2-3. Recommended Screw Torques.....	2-2
Table 2-4. RAM Board Replacement Part Numbers.....	2-4
Table 2-5. Hard Disk Drive Replacement Part Numbers	2-5
Table 2-6. Replacing Small Parts (User-Replaceable)	2-8
Table 2-7. Display Component Compatibility.....	2-13
Table 2-8. CPU Component Compatibility	2-19

Table 2-9. Removing Display Components.....	2-31
Table 2-10. Removing Top Case Components.....	2-32
Table 2-11. Removing Bottom Case Components	2-33
Table 3-1. Scope of Diagnostic Tools	3-4
Table 3-2. Troubleshooting Suggestions	3-5
Table 3-3. OmniBook Diagnostic Error Codes	3-15
Table 3-4. POST Terminal-Error Beep Codes	3-20
Table 3-5. POST Messages	3-21
Table 3-6. Sycard PCCTest Commands	3-23
Table 3-7. BIOS Setup Menus and Parameters	3-26
Table 4-1. OmniBook Replaceable Parts	4-3
Table 4-2. Assembly-Component Breakdown.....	4-8
Table 4-3. Accessory Replaceable Parts.....	4-9
Table 4-4. Part Number Reference	4-10
Table 5-1. OmniBook 4100/4150 LCD Guidelines (TFT).....	5-3
Table 5-2. Service Notes	5-6
Table 5-3. Obsolete Repair Parts.....	5-6

Introduction

This service manual provides reference information for the HP OmniBook 4100/4150. It is intended to be used by HP-authorized service personnel in the installation, servicing, and repair of these products.

The manual is designed as a self-paced guide. It is intended to train you to install, configure, and repair OmniBook computers. You can follow this manual without having equipment available.

The following table lists additional places where you can get supplementary information about OmniBook products.

Sources of OmniBook Information

Source	Address or Number	Comments
HP External Web	http://www.hp.com/omnibook (http://www.europe.hp.com/omnibook , European mirror)	No usage restriction.
HP US Reseller Web	http://partner.americas.hp.com	Restricted to Authorized Resellers only.
HP Asia Pacific Channel Support Centre for DPSP Partners	http://www.hp.com.au	Restricted to DPSP Partners only.
America Online	Keyword: HP	Call (800) 827-6364 for membership within the US.
CompuServe	GO HP	Call (800) 524-3388 for membership within the US.
HP Bulletin Board Service		Refer to the latest Product Support Plan for non-US BBS numbers.
HP Support Assist CD-ROM	(800) 457-1762	US and Canada.
	(801) 431-1587	Outside US and Canada.
Microsoft Web	http://www.microsoft.com	Information and updates for Windows operating systems.

Product Information

The HP OmniBook 4100/4150 provides desktop performance and expandability as well as convenient portability. It uses high-performance component technologies that make it capable of replacing a desktop computer or serving as a portable multimedia presentation tool.

Table 1-1. Product Comparisons

	OmniBook 7100/7150	OmniBook 4100/4150	OmniBook 2100/3100	OmniBook 900
Processor *	Intel Pentium II (300 or 266 MHz).	Pentium II (233 to 400 MHz), or Pentium (266 MHz).	Pentium II (300, 266, or 233 MHz), or Pentium (266, 233, or 200 MHz).	Intel Pentium II (366 or 300(PE) MHz).
Memory	64 MB RAM in system slot or 32 MB RAM on motherboard. Expandable to 320 or 288 MB.	128 or 64 MB RAM in slot or 32 MB RAM on motherboard. Expandable to 256 or 160 MB.	32 MB RAM on motherboard. Expandable to 160, 192, or 288 MB.	32 MB RAM on motherboard. Expandable to 160 MB.
Display	14.1-inch TFT XGA display.	14.1- or 13.3-inch TFT XGA display.	13.3-inch TFT XGA display, or 12.1-inch TFT or DSTN SVGA display.	12.1-inch TFT SVGA display.
Video	AGP or PCI local bus video. 64-bit graphics controller with 4 MB external video RAM, 3Dgraphics acceleration. Up to 16M colors (XGA). Zoomed Video enabled.	AGP or PCI local bus video. 256- or 128-bit graphics controller with 8, 4, 2.5 or 2 MB internal video RAM. Up to 16M or 64K colors (XGA). Zoomed Video enabled.	PCI local bus video. 128-bit graphics controller with 2 MB internal video RAM. Up to 64K colors (XGA), 16M colors (SVGA). Zoomed Video enabled.	AGP video. 256-bit graphics controller with 2.5 MB internal video RAM. Up to 16M colors (XGA). Zoomed Video enabled.
Operating System	Windows 95, Windows 98, or Windows NT 4.0 preinstalled.	Windows 95, Windows 98, or Windows NT 4.0 preinstalled.	Windows 95, Windows 98, or Windows NT 4.0 preinstalled.	Windows 95, Windows 98, or Windows NT 4.0 preinstalled.
Desktop Management Interface	DMI 2.0. HP TopTools 2.6 or 3.0.	DMI 2.0. HP TopTools 2.6 to 4.5.	DMI 2.0. HP TopTools 2.6 or 3.0.	DMI 2.0. HP TopTools 3.0.
Power Management	APM 1.2. ACPI compliant.	APM 1.2. ACPI compliant.	APM 1.2. ACPI compliant.	APM 1.2. ACPI compliant.
Power States	On, Standby, Suspend, Hibernate, Off.	On, Standby, Suspend, Hibernate, Off.	On, Standby, Suspend, Hibernate, Off.	On, Standby, Suspend, Hibernate, Off.
* Intel Mobile Pentium processor.				

Table 1-2. OmniBook 4100/4150 Series Models

OmniBook Product *	CPU **	Display	Hard Drive	Floppy Drive	CD-ROM Drive	Standard RAM
OmniBook 4100						
F1462x	Pentium II 233 MHz	13.3-inch XGA TFT	4 GB (F1467A)	1.44 MB (F1472A)	CD-ROM (F1474A)	32 MB
F1463x***	Pentium 266 MHz	14.1-inch XGA TFT	6 GB (F1475A)			
F1464x	Pentium II 266 MHz					
F1479x						
F1703x			13.3-inch XGA TFT			
OmniBook 4150 Series						
F1629x	Pentium II 300 MHz	14.1-inch XGA TFT	6 GB (F1475A)	1.44 MB (F1472A)	CD-ROM (F1474A)	64 MB (F1457A)
F1640x	Pentium II 333 MHz					
F1641x	Pentium II 366 MHz					
F1642x			10 GB (F1744A)		DVD Drive (F1653A)	128 MB (F1622A)
F1647x	Pentium II 300 MHz		4.8 GB (none)		CD-ROM (F1474A)	64 MB (F1457A)
F1648x	Pentium II 400 MHz		10 GB (F1744A)		DVD Drive (F1653A)	
F1658x ^B	Pentium II 366 MHz	13.3-inch XGA TFT	4.8 GB (none)		CD-ROM (F1474A)	64 MB (F1457B)
F1660x ^B	Pentium II 400 MHz	14.1-inch XGA TFT	6 GB (F1475A)			
F1663x	Pentium II 366 MHz		4.8 GB (none)			
<p>This table lists only base product configurations—custom configurations are not included.</p> <p>* For the products listed: "x" suffix means "N", "NT", "NV", "NG" for Windows NT 4.0 installed (marketing distinction only), or "W", "WT", "WV", "WG", "WR" for Windows 95 or Windows 95/98 installed (marketing distinction only).</p> <p>** Intel Mobile Pentium or Pentium II processor.</p> <p>*** Available only with Spring '98 software—other OmniBook 4100 products rolled to Fall '98 software. All OmniBook 4150 products were released with Fall '98 software or later.</p> <p>^B The OmniBook 4150 Series has two classes of products with different internal designs, different software drivers, and different BIOSes. Models marked with ^B have "4150 B" after the serial number and are called 4150B in this manual—other OmniBook 4150 models listed in this table are called 4150† in this manual, and they have no marking after the serial number.</p>						

Features and Operation

The following three illustrations point out the main external features of the computer. They are followed by highlights of the computer's operation. For an internal, exploded view, see page 4-2.

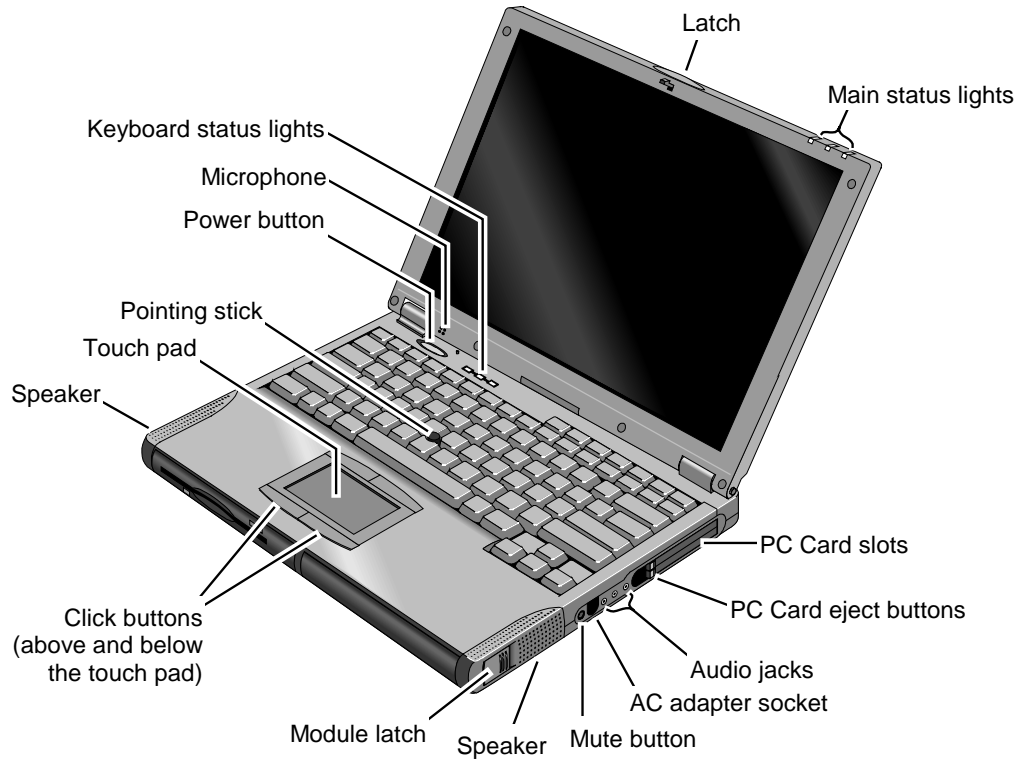

Figure 1-1. OmniBook - Front View

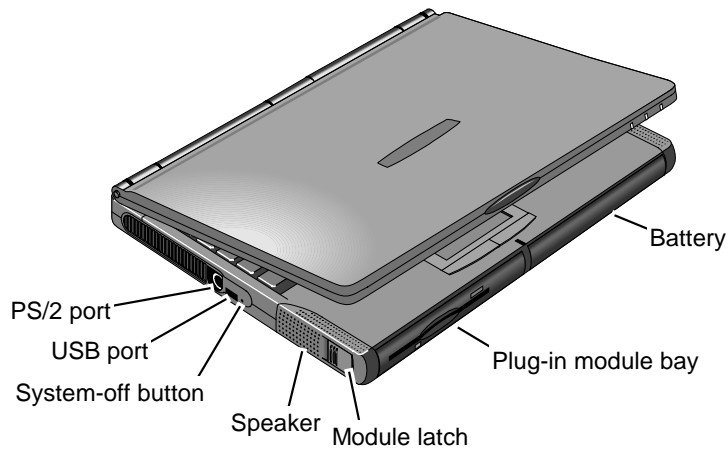

Figure 1-2. OmniBook - Side View

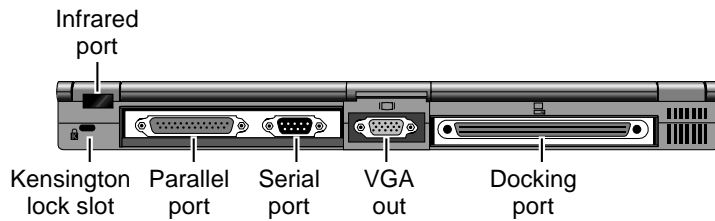

Figure 1-3. OmniBook - Rear View

Turning the OmniBook On and Off

- **On.** Press the blue power button to turn on the OmniBook.
- **Standby.** The display turns off automatically if the computer is inactive for about 2 minutes.
- **Suspend.** Click Start, Suspend (Windows 95) or press the blue power button briefly (about 1 second) to suspend activity when the OmniBook is on. When you turn on the computer, it resumes your previous work session.

Closing the lid (for more than 2 seconds) also suspends the computer.

- **Hibernate.** Press Fn+F12. This is like Off, except that your current work session is first saved to disk. When you turn on the computer, it reboots and restores your previous session.
- **Off.** Click Start, Shut Down. If the OmniBook does not respond, press and hold the blue power button until the display shuts down. When you turn on the computer, it reboots. Unsaved data is lost.













Table 1-3. Activating Power Modes

Power Mode	To Enter Mode	To Turn Back On
Standby Reduced-power/stopped state. Display is off. Everything is in a reduced-power state. Network devices are maintained. Your current work session continues at turn-on (any key or pointer action).	Press Fn+S (not Windows 98) –or– allow time-out.	Press any key or move a pointing device to display the current session ("Instant-On").
Suspend Low-power/stopped state. Lower power state than Standby. Everything is off or in a low-power state. Network devices are off. Your previous work session resumes at turn-on. For plug-and-play operating systems, network connections resume at turn-on.	Press blue power button for about 1 second –or– click Start, Shut Down, Standby (Windows 98) –or– click Start, Suspend (Windows 95) –or– allow time-out.	Press blue power button to display the current session ("Instant-On").
Hibernate No-power/stopped state. Session is saved on the hard disk. Everything is shut down. Computer reboots at turn-on and restores previous session and network connections (if plug-and-play).	Press Fn+F12 –or– allow time-out.	Press blue power button to restart and restore the previous session.
Off No-power/stopped state. Everything is shut down (battery continues charging if ac adapter is connected). Computer reboots at turn-on and restores network connections.	Click Start, Shut Down –or– Press and hold the blue power button until the display shuts down.	Press blue power button to restart with a new session.

Checking the Status of the OmniBook













The main OmniBook status lights, located at the front-right edge of the display bezel at the top of the display, indicate power status and drive activity. (These lights are on the LED strip cable.)

Table 1-4. Main Status Lights (LED Strip Cable)

  	Meaning
  	Power mode Steady green light: OmniBook is running (On mode). Steady orange light: OmniBook is suspended (Suspend or Standby mode). No light: OmniBook is off (Off or Hibernate mode). Green and orange lights: OmniBook failed when resuming.
  	Drive access Green light: OmniBook is accessing the hard disk drive, floppy disk drive, or a drive in the plug-in module bay. For the OmniBook 4100, it also indicates PC Card activity.
  	Charging Steady green light: AC adapter is connected, battery is full or stopped charging. Blinking green light: AC adapter is connected, battery is charging. No light: AC adapter is not connected or battery is not present.

The keyboard status lights, located above the keyboard, indicate the states of the keyboard locks. (These lights are on the VGA PCA for the OmniBook 4100, and on the motherboard for the OmniBook 4150 Series.)

Table 1-5. Keyboard Status Lights (VGA PCA or Motherboard)

  	Meaning
  	Caps Lock Caps Lock is active.
  	Keypad Lock The embedded keypad is active (Fn+F8 or Fn held down). Num Lock must also be on for the numeric keys—otherwise, cursor control is active.
  	Num Lock Num Lock is active.

In addition, the battery module has five lights that indicate its charge level. To view the lights, you have to remove the battery and press the pad on the back next to the connector. The number of lights that turn on indicates the charge.

Using Fn Hot Keys

The Fn key combined with another key is a hot key—a shortcut key sequence for various system controls. For an external keyboard, CTRL+ALT is normally equivalent to the Fn key.

Table 1-6. Fn Hot Keys

Hot Key	Effect
Fn + F1	Decreases the display's brightness.
Fn + F2	Increases the display's brightness.
Fn + F3	Decreases the display's contrast (non-TFT displays only).
Fn + F4	Increases the display's contrast (non-TFT displays only).
Fn + F5	Switches among the built-in display, an external display, and simultaneous displays.
Fn + F8	Toggles the embedded keypad on and off. Does not affect an external keyboard. If Num Lock is on, then the numeric functions are active—otherwise, cursor control is active.
Fn + F12	Enters Hibernate mode.
Fn + R	Enters Suspend mode.
Fn + S	Enters Standby mode (Windows 95, Windows NT) or Suspend mode (Windows 98).
Fn + ScrLk	Toggles Scroll Lock on and off.
Fn + UP ARROW Fn + DOWN ARROW	Increases and decreases the sound volume.

Resetting the OmniBook

1. Use a pen or a straightened paper clip to push the system-off button on the left side of the OmniBook. (The switch is on the motherboard.)

–or–

Press and hold the blue power button until the display shuts down. (The switch is on the motherboard.)

2. After the computer shuts down, press the blue power button to turn it back on.

Note

The OmniBook can boot from a CD if all these conditions are true:

- You have an internal CD-ROM or DVD drive installed,
- You have a bootable CD in the drive, such as the OmniBook Recovery CD, and
- You select the CD-ROM or DVD drive as the boot device. You can do this during reboot by pressing ESC to cancel the OmniBook screen, then ESC to display the boot-device menu for a one-time selection.

System Resources

Below are default values for system resources. To see other, non-default possibilities, use the BIOS Setup utility (see page 3-26), which lists port and audio device configurations in the System Devices menu.

The tables in this section show typical resource usage as set up by the OmniBook BIOS. Plug-and-play operating systems, drivers, and BIOS Setup settings may change some of the entries.

Table 1-7. System Interrupts

0	System timer
1	Keyboard
2	Cascade IRQ 9
3	Free (or COM2 infrared port, if enabled)
4	COM1 (serial port)
5	Audio
6	Floppy drive
7	LPT1 (ECP parallel port)
8	Real-time clock
9	Free (OmniBook 4100/4150B) Video (OmniBook 4150†)
10	USB and CardBus - assigned by Windows driver Video Controller (OmniBook 4150B)
11	Free
12	Pointing device
13	Numeric data processor
14	Internal hard disk (primary IDE controller)
15	Internal CD-ROM drive (secondary IDE controller)
† Models called 4150† in this manual have no marking in the serial number, whereas models called 4150B have 4150 B after the serial number.	

Table 1-8. System Memory

00000 - 9FFFF	System memory
A0000 - BFFFF	Video
C0000 - CBFFF	Video BIOS (OmniBook 4100/4150†)
C0000 - CFFFF	Video BIOS (OmniBook 4150B)
CC000 - DBFFF*	Free** (OmniBook 4100/4150†)
D0000 - DBFFF*	Free** (OmniBook 4150B)
DC000*- FFFFF	System BIOS
* Approximate boundary.	
** Valid uses for memory addresses CC000-DBFFF or D0000-DBFFF: Upper memory blocks (UMBs). PC card memory windows.	
† Models called 4150† in this manual have no marking in the serial number, whereas models called 4150B have 4150 B after the serial number.	

Table 1-9. System Input/Output Addresses (100-3FF)

120-127	Audio (OmniBook 4150† only)
170-177	Internal CD-ROM drive (secondary IDE controller)
1F0-1F7	Internal hard disk (primary IDE controller)
220-22F	Audio
376	Internal CD-ROM drive (secondary IDE controller)
378-37F	LPT1 (printer port)
388-38B	Audio
3B0-3BB	VGA adapter
3C0-3DF	VGA adapter
3E0-3E1	PCMCIA controller
3F0-3F5	Floppy controller
3F6	Internal hard disk (primary IDE controller)
3F7	Floppy controller
3F8-3FF	COM1 (serial port)
† Models called 4150† in this manual have no marking in the serial number, whereas models called 4150B have 4150 B after the serial number.	

Table 1-10. DMA Channels

0	Sound record (OmniBook 4100/4150†) Free (OmniBook 4150B)
1	Sound playback
2	Floppy drive
3	LPT1 (ECP parallel port)
4	Cascade
5	Free
6	Free
7	Free
† Models called 4150† in this manual have no marking in the serial number, whereas models called 4150B have 4150 B after the serial number.	

Specifications

The following tables list descriptions for the OmniBook and its accessories.

Table 1-11. OmniBook 4100/4150 Series Specifications

Physical Attributes	Size: 330.5mm×256.9mm×35-36.5mm (13.0"×10.1"×1.3-1.4"). Weight: 2.92-2.99 kg (6.45-6.60 lb.).
Processor and Bus Architecture	300/333/366/400 MHz Pentium II processor with internal 256 KB 4-way, set-associative L2 cache. –or– 233/266/300-MHz Intel Pentium II, or 266-MHz Intel Pentium processor with 512-KB pipeline-burst-synchronous L2 cache. 1.6- to 1.8-V core, 2.5-V external, low-power processor. 32-KB (16-KB instruction, 16-KB data) L1 cache. 32-bit PCI bus.
Graphics	14.1- or 13.3-inch XGA active-matrix (TFT) display. Zoomed Video support for lower PC Card slot. OmniBook 4150B: ATI Mobility-M or -M1 graphics accelerator with 4- or 8-MB video RAM (1024 × 768 × 16M colors). 2X AGP graphics capability. OmniBook 4150†: 256-bit NeoMagic MagicGraph graphics accelerator with 2.5-MB video RAM (1024 × 768 × 16M colors). 1X AGP graphics capability. OmniBook 4100: 128-bit NeoMagic MagicGraph graphics accelerator with 2-MB video RAM (1024 × 768 × 64K colors). Zoomed Video support for both PC Card slots.
Power	Rechargeable 9-cell lithium ion battery with LED charge-level gauge (10.8 Vdc, 4.2 AH or more, 45 watt-hours or more). Battery life (one battery): up to 3-4 hours typical (varies with type of usage and model). Fast battery recharge: 80% in 1.5-2 hours, 100% in 2-2.5 hours. Low-battery warning. Suspend/resume capability. 60-watt ac adapter: 100 to 240 Vac (50 to 60 Hz) input, 19 Vdc, 3.16 A output.
Mass Storage	4, 6, or 10 GB removable hard drive. Standard 1.44-MB floppy drive module. Standard 24X CD-ROM drive module or DVD drive module. Optional LS-120 SuperDisk module. Optional DVD drive. Optional 10 GB second hard drive module.
RAM	OmniBook 4150† or 4150B: 128 MB or 64 MB SDRAM in first RAM slot. Two total slots for RAM expansion up to 256 MB (using 128 MB modules). 66 MHz RAM bus, or 100 MHz RAM bus for OmniBook 4150B. OmniBook 4100: 32-MB SDRAM on motherboard. One slot for RAM expansion up to 160 MB. 66 MHz RAM bus.

Audio System	16-bit, Sound Blaster Pro-compatible. SRS 3D enhanced audio. Stereo sound via two built-in speakers. Built-in microphone. Line-in, headphone-out, and microphone-in.
Keyboard and Pointing Device	87/88-key touch-type QWERTY keyboard with 101/102 key emulation. Embedded numeric keypad. 12 function (Fn) keys. Two pointing devices: pointing stick (technology licensed from IBM) and touch pad.
Input/Output	FDD/IDE interface for external module bay. Universal serial bus (USB). 9-pin, 115,200-bps serial (16550 UART). 25-pin bi-directional ECP/EPP parallel. Video-out (up to 1024×768×64K colors, or up to 1600×1200×64K or 16M colors for OmniBook 4150B. Refresh rate 60 to 85-Hz). Dual display. PS/2 keyboard/mouse. 4-Mbps IrDA-compatible infrared port.
Expandability	One Type III or two Type II 16-/32-bit PC Card slots (3.3- and 5-V support). CardBus enabled. Plug-in module bay for accessory modules. Optional port replicator, mini dock, and docking system.
Preinstalled Software	Microsoft Windows 95, Windows 98, or Windows NT 4.0. Windows 95/98-compatible Plug-and-Play. Windows NT 4.0 APM and PC Card Plug-and-Play. Advanced Power Management (APM 1.2). DMI 2.0 with HP TopTools 2.6 to 4.5 DiagTools. Agate Tioman for HP (Hot Swap). Adobe Acrobat Reader. Virus Scan software. Online documentation. OmniBook Recovery CD-ROM included. Centralized worldwide BIOS and driver update service.
Security Features	User and administrator passwords. System, hard drive, and docking passwords. PC identification displayed at boot. DMI-accessible electronic serial number. Kensington Microsaver lock slot.
Environmental Limits	Operating temperature: 5 to 35 °C (41 to 95 °F). Operating humidity: 20 to 90 percent RH (5 to 35 °C). Storage temperature: -20 to 50 °C (-4 to 122 °F).

Major ICs**OmniBook 4150B:**

CPU: Intel Mobile Pentium II.
South Bridge: PIIX4M.
Video: ATI Mobility-M or -M1.
Audio: ESS ES1978 Maestro-2E and ESS ES1921.
CardBus: TI PCI 1225.
Keyboard controller: National PC87570.
Super I/O: SMC 869.

OmniBook 4150†:

CPU: Intel Mobile Pentium II.
South Bridge: PIIX4E.
Video: NeoMagic MagicGraph NM2200 (NMG5).
Audio: NeoMagic MagicGraph NM2200 (NMG5) and NeoMagic Audio MNA2.
CardBus: TI PCI1220A.
Keyboard controller: National PC87570.
Super I/O: SMC 769.

OmniBook 4100:

CPU: Intel Mobile Pentium or Pentium II.
South Bridge: PIIX4E.
Video: NeoMagic MagicGraph NM2160 (NMG4).
Audio: Crystal CS4237B.
CardBus: TI PCI1250A.
Keyboard controller: National PC87570.
Super I/O: SMC 769.

† Models called 4150† in this manual have no marking in the serial number, whereas models called 4150B have 4150 B after the serial number.

Table 1-12. OmniBook 4100/4150 Series Accessories

Accessory	Description	OmniBook			Compat. 2100/7100
		4150B	4150†	4100	
Memory					
F1456A	32-MB SDRAM (66 MHz) expansion module		•	•	•
F1457A	64-MB SDRAM (66 MHz) expansion module		•	•	•
F1622A	128-MB SDRAM (66 MHz) expansion module		•	•	•
F1456B	32-MB SDRAM (100 MHz) expansion module	•	•	•	•
F1457B	64-MB SDRAM (100 MHz) expansion module	•	•	•	•
F1622B	128-MB SDRAM (100 MHz) expansion module	•	•	•	•
Hard Drives					
F1467A	4-GB internal hard disk drive		•	•	
F1475A	6-GB internal hard disk drive	•	•	•	
F1744A	10-GB internal hard disk drive	•	•		
Modules					
F1465A/B	DVD drive module (with DVD player card)	•	•	•	
F1470A	LS-120 SuperDisk drive module	•	•	•	
F1472A	Floppy drive module	•	•	•	
F1473A	Floppy drive cable for external use	•	•	•	
F1474A	24X CD-ROM drive module	•	•	•	
F1653A/B	4X DVD drive module	•	•		
F1746A	10-GB second hard drive module	•	•		
Power Options					
F1454A	60-watt ac adapter	•	•	•	•
F1455A	75-watt auto/airline power adapter	•	•	•	•
F1466A	Lithium-ion battery (primary and secondary)	•	•	•	
F1620A	Battery charger (external)	•	•	•	
8120-6312	Replacement power cord (Australia)	•	•	•	•
8120-6313	Replacement power cord (U.S., Canada, Taiwan)				
8120-6314	Replacement power cord (Europe)				
8120-6316	Replacement power cord (Japan)				
8120-6317	Replacement power cord (India, South Africa)				
8120-8367	Replacement power cord (Argentina)				
8120-8373	Replacement power cord (People's Republic of China)				
8120-8452	Replacement power cord (Chile)				
8120-8699	Replacement power cord (Hong Kong, Singapore, U.K.)				
Adapters					
F1469A	PS/2 Y adapter	•	•	•	•
PC Cards					
F1623A	10/100-Mbps Ethernet + 56-Kbps modem PC Card by Xircom	•	•	•	•
F1625A	56-Kbps global modem PC Card by Xircom	•	•	•	•
F1626A	10/100-Mbps Ethernet PC Card by 3Com	•	•	•	•
F1627A	56-Kbps US modem PC Card by Xircom	•	•	•	•
F1643A	Realport 10/100-Mbps Ethernet + 56-Kbps modem PC Card by Xircom	•	•	•	•

Docks					
F1451A	Port replicator	•	•	•	•
F1452A	Mini dock	•	•	•	•
F1453A	Monitor stand (short) for F1451A and F1452A	•	•	•	•
F1468A	Docking module bay adapter	•	•	•	
F1477A	Docking system and monitor stand (tall)	•	•	•	•
† Models called 4150† in this manual have no marking in the serial number, whereas models called 4150B have 4150 B after the serial number.					

Internal Design

The motherboard PCA is the central component of the OmniBook design. It plays a role in virtually all system functions. The CPU module (MMO) and most other subsystems connect to the motherboard.

The following figure shows the connections among the replaceable electrical modules. As a substitute for a functional block diagram, see the table on page 1-15—it lists the roles that the replaceable modules play in each of the functional subsystems.

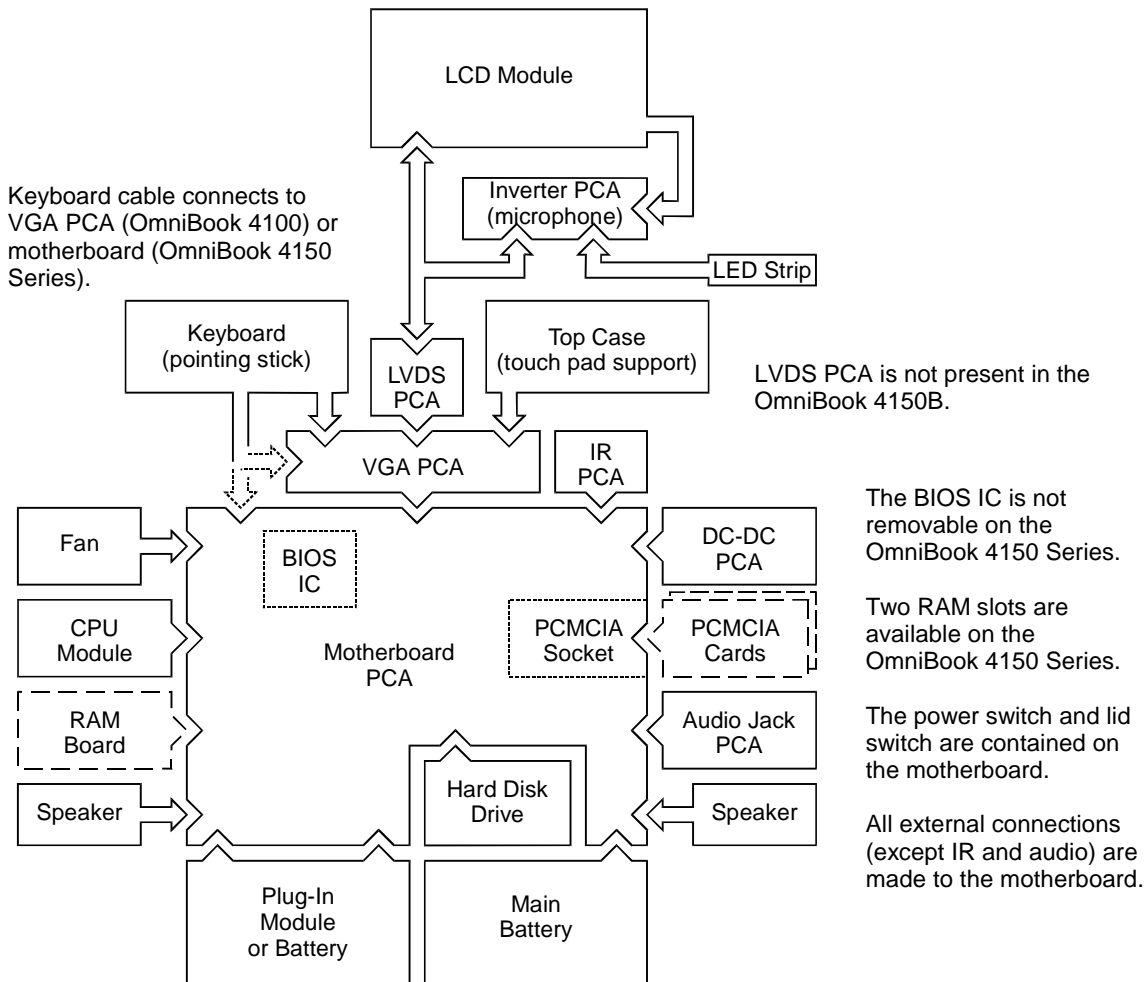

Figure 1-4. Replaceable Module Diagram

Table 1-13. Functional Structure

Bootup	CPU module Motherboard BIOS IC Floppy disk module Hard disk drive	Main processor (MMO). Primary system circuitry. Code for basic system functions (part of motherboard on OB 4150). First source of disk-based startup code. Second source of disk-based startup code.
Processor	CPU module Motherboard	Main processor, numeric data processor, L1 and L2 cache. Primary system circuitry.
Memory	Motherboard RAM board VGA PCA	No onboard RAM (OB 4150), or first 32 MB of RAM (OB 4100). Changeable RAM (1 slot on OB 4100, 2 slots on OB 4150). Video RAM.
Power	Battery Motherboard DC-DC PCA AC adapter	Power storage. AC adapter socket, power switch, lid switch, system-off switch, power supply. Power control circuitry. AC-to-dc converter.
Display	Motherboard LCD module Inverter PCA LVDS PCA VGA PCA	PCMCIA/zoomed video controller. Display output, backlight. Power converter for backlight. Display drivers, LVDS processing (OB 4100/4150†). Display/graphics controller, video RAM (OB 4150B: LVDS processing).
Hard disk	Motherboard Hard disk drive	Hard disk controller. Hard disk mechanism.
Floppy drive	Motherboard Floppy disk module	I/O controller, floppy connector. Floppy disk mechanism.
Keyboard	Motherboard BIOS IC Keyboard	Keyboard controller. Keyboard BIOS (part of motherboard on OB 4150). Key switches.
Pointer	Motherboard BIOS IC Keyboard Top case	Keyboard controller, pointing stick controller (PS/2 output). Keyboard BIOS (part of motherboard on OB 4150). Pointing stick sensor. Touch pad sensor, controller (PS/2 output).
Audio	Motherboard VGA PCA Audio jack PCA Inverter PCA Speakers	Audio controller (OB 4100/4150B), audio decoder, speaker amplifier, headphone amplifier, zoomed video controller, mute switch. Audio controller (OB 4150†). External audio jacks. Microphone. Speakers.
Status	Motherboard LED strip cable VGA PCA	Keyboard controller, plus keyboard LEDs (OB 4150). Main LEDs. Keyboard LEDs (OB 4100).
Serial	Motherboard	I/O controller, serial connector.
Parallel	Motherboard	I/O controller, parallel connector.
Infrared	Motherboard IR PCA	I/O controller. Infrared transmitter/receiver.
PS/2 port	Motherboard	Keyboard controller, PS/2 connector.
USB	Motherboard	Bus controller (South Bridge), USB connector.
Docking port	Motherboard	Docking logic, docking connector.
PCMCIA	Motherboard PCMCIA socket	PCMCIA controller. PCMCIA connectors.
† Models called 4150† in this manual have no marking in the serial number, whereas models called 4150B have 4150 B after the serial number.		

Removal and Replacement

This chapter tells you how to remove and replace the following components and assemblies. The ones marked by • are user-replaceable.

Table 2-1. Removal Cross-Reference

<ul style="list-style-type: none"> Air vent cover (table on page 2-33). Audio jack cover (table on page 2-33). Audio jack PCA (table on page 2-33). • Battery (page 2-3). BIOS IC (page 2-28). Bottom case (page 2-19). Cable holder (table on page 2-31). CPU bottom plate (table on page 2-33). CPU module (page 2-13). CPU top plate (table on page 2-33). DC-DC PCA (table on page 2-33). Display bezel (table on page 2-31). Display case (table on page 2-31). Display latch (table on page 2-31). • Docking door (table on page 2-8). End cap (table on page 2-31). Fan (table on page 2-33). • Foot (table on page 2-8). Frame (table on page 2-33). • Hard disk drive (page 2-5). Heatsink parts (table on page 2-33). Hinge (table on page 2-31). • Hinge cover (table on page 2-8). 	<ul style="list-style-type: none"> Inverter PCA (table on page 2-31). • I/O door (table on page 2-8). IR PCA (table on page 2-33). Keyboard (page 2-9). LCD brackets (table on page 2-31). LCD flex cable (table on page 2-31). LCD module (page 2-13). LCD shield (table on page 2-31). LED strip cable (table on page 2-31). LVDS PCA (table on page 2-33). Module latch (table on page 2-33). Motherboard (page 2-19). PCMCIA socket (table on page 2-33). • Plug-in module (page 2-3). • RAM board (page 2-4). • RAM/BIOS cover (table on page 2-8). Speaker cover (table on page 2-33). Speaker (table on page 2-33). Spring, grounding (table on page 2-33). Strip cover (table on page 2-32). Top case (page 2-16). • VGA connector cover (table on page 2-8). VGA PCA (table on page 2-33).
---	--

Caution

Always provide proper grounding when performing repairs. Without proper grounding, an electrostatic discharge may damage the OmniBook and its components.

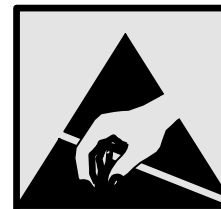

Notes

Reassembly steps are the reverse of the removal steps. Reassembly notes are included at the end of each section below.

 Symbols like this throughout this chapter show approximate full-size screw outlines. You can use them to verify the sizes of screws before you install them. Installing a wrong-size screw can damage the unit. (The symbol at the left represents an M2.5x5mm T-head screw.)

Table 2-2. Required Equipment

- Small Phillips screwdriver, preferably magnetized.
- 5 mm hex driver.
- Pointed knife or probe.
- Small flat-blade screwdriver.
- IC (PLCC) removal tool (similar to OK Industries EX-5).
- OmniBook 4150† CPU removal tool (HP part number T-335665).

Table 2-3. Recommended Screw Torques

Screw Thread Size	Torque (kgf•cm)	Torque (lbf•in)
M2	1.3 – 1.8	1.1 – 1.5
M2.5 (4–5 mm long)	3.0 – 3.5	2.6 – 3.0
M2.5 (16–19 mm long)	2.5 – 3.0	2.2 – 2.6
M3	3.0 – 3.5	2.6 – 3.0

Removing the Battery or Plug-In Module (User-Replaceable)

Required Equipment

- None.

Removal Procedure

1. Unplug the ac adapter, if present.
2. Slide forward the module latch slider on the corner next to the module, then swing back the latch to loosen the module.
3. Pull out the module.
4. Slide the latch back into the case.

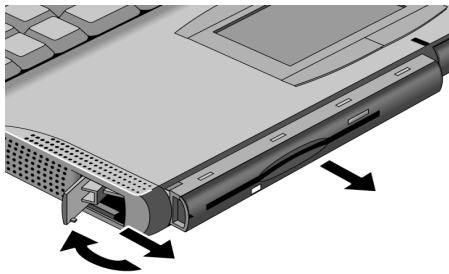

Figure 2-1. Removing the Battery or Plug-In Module

Reassembly Notes

- **Important:** You must slide the latch forward before you can insert a module.
- You can install a battery in either bay. Any other type of module must be installed in the left bay.

Removing a RAM Board (User-Replaceable)

The OmniBook 4100 has 32 MB of RAM on the motherboard and has one RAM slot for installing additional RAM. The OmniBook 4150 Series has no RAM on the motherboard and has two RAM slots for installing RAM.

Table 2-4. RAM Board Replacement Part Numbers

Description	Part Number	Exchange Part Number	OmniBook		
			4150B	4150†	4100
RAM board, 32-MB SDRAM (66 MHz)	1818-7413	F1456-69001		•	•
RAM board, 64-MB SDRAM (66 MHz)	1818-7414	F1457-69001		•	•
RAM board, 128-MB SDRAM (66 MHz)	1818-7549	F1622-69001		•	•
RAM board, 32-MB SDRAM (100 MHz)	1818-7950		•	•	•
RAM board, 64-MB SDRAM (100 MHz)	1818-7951		•	•	•
RAM board, 128-MB SDRAM (100 MHz)	1818-7952		•	•	•

† Models called 4150† in this manual have no marking in the serial number, whereas models called 4150B have 4150 B after the serial number.

Caution

Handle the RAM board only by its edges and provide proper grounding. Otherwise, you may damage the board due to electrostatic discharge.

Required Equipment

- Small Phillips screwdriver.

Removal Procedure

1. Unplug the ac adapter, if present, and remove the battery.
2. Turn the unit bottom side up, then remove the two screws from the RAM/BIOS cover and remove the cover.
3. Release the two latches at the sides of the RAM board, so the free edge of the board pops up.
4. Pull the board out of the connector.

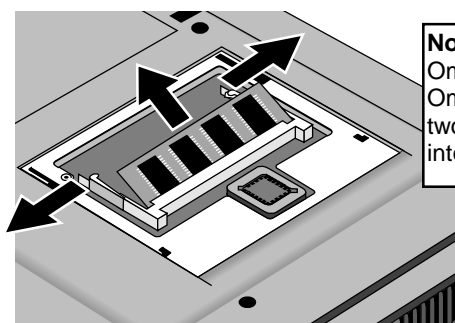

Note:

OmniBook 4100 shown. For the OmniBook 4150 Series, there are two RAM slots (with no RAM built into the motherboard).

Figure 2-2. Removing a RAM Board

Reassembly Notes

- Insert the RAM board into the connector at about a 30° angle until it is fully inserted. Then press down at both sides until both latches snap closed.

Removing the Hard Disk Drive (User-Replaceable)

Table 2-5. Hard Disk Drive Replacement Part Numbers

Description	Part Number	Exchange Part Number	OmniBook		
			4150B	4150†	4100
Drive, hard disk (4.0GB, 12.7mm, IBM)	0950-2671	F1386-69100			•
Drive, hard disk (4.0GB, 12.7mm, Toshiba)	0950-2865	F1386-69101			•
Drive, hard disk (4.3GB, 9.5mm, IBM)	0950-3409	F1711-69100		•	•
Drive, hard disk (4.8GB, 9.5mm, IBM) *	0950-3611	F1711-69102	•	•	•
Drive, hard disk (6.4GB, 9.5mm, IBM) *	0950-3442	F1711-69101	•	•	•
Drive, hard disk (6.4GB, 12.7mm, IBM)	0950-2785	F1475-69100		•	•
Drive, hard disk (6.4GB, 8.4mm, Toshiba)	0950-3675	F1475-69102	•	•	•
Drive, hard disk (6.4GB, 12.7mm, Toshiba)	0950-3397	F1475-69101		•	•
Drive, hard disk (10.1 GB, 12.5mm, IBM) *	0950-3443	F1744-69101	•	•	

* These hard drives are the preferred drives at the time of publication. Drives shipped in units are subject to change without notice. For current information about preferred and approved drives for these products, see the latest version of service note HDD-01.

† Models called 4150† in this manual have no marking in the serial number, whereas models called 4150B have 4150 B after the serial number.

Required Equipment

- Small Phillips screwdriver.
- Small flat-blade screwdriver.

Removal Procedure

1. Unplug the ac adapter, if present, and remove the battery.
2. Turn the unit bottom side up.
3. Remove the hard drive screw from the bottom case.
4. Pull out the hard drive by its plastic tab.

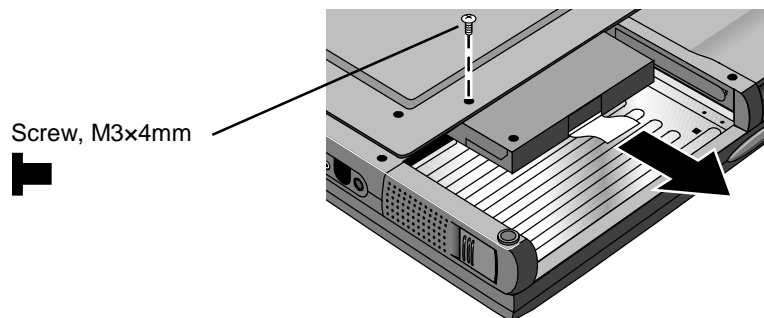

Figure 2-3. Removing the Hard Disk Drive

5. If you are installing a new hard drive that does not have a cover, you can remove the cover parts from the old hard drive:

- Remove the screw from the case, then pry open the flap. If necessary, use a flat-blade screwdriver
- Use a flat-blade screwdriver to pry open the snaps at the ends of the case, then open the connector-side of the case.
- Pry out the corner next to the connector, then lift out the connector and hard drive together.
- Unplug the internal connector and cable from the hard drive.

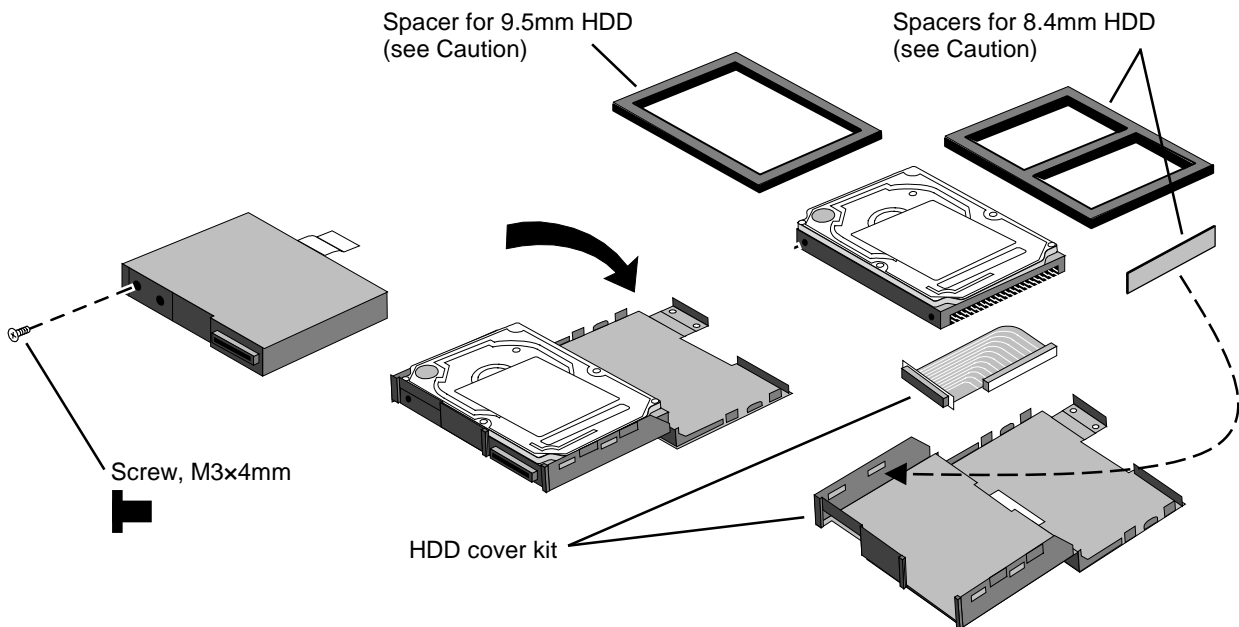

Figure 2-4. Installing a Hard Drive in the Cover

Reassembly Notes

Caution

- Do not cover the vent hole in the top surface of the hard drive or in the case. If you cover the hole, the hard drive could fail prematurely.
- If you install a 9.5-mm hard drive in the case, make sure you install the spacer on top of the drive. If you install an 8.4-mm hard drive, make sure you stick the end spacer on the case and install the top spacer on top of the drive.

- Pry out the connector corner of the case and insert the external connector and hard drive at the same time. The connector seats in the lower part of the opening in the case.
- Secure the two tabs on the screw flap by inserting the corner tab last, while prying out the nearby corner of the case.
- When you install the battery module, be sure the plastic tab on the hard drive case lays folds up against the front of the case.

Important

- If you are installing a new hard drive, create a Hibernate partition on the drive before loading any software—see the steps below.

Creating a Hibernate Partition – OmniBook 4100

1. If you do not have an OmniBook Recovery CD and internal CD-ROM (or DVD) module for the computer you are repairing, create a Support Utility floppy disk now.

After inserting a formatted floppy disk in the floppy drive, do one of the following:

- On an OmniBook 4100 with a Spring-98 factory software installation, click Start, Programs, OmniBook, Create Support Utility Disk.
 - On any computer that has a CD-ROM drive, run **makesupp** from the \OmniBook\Drivers\Hputils directory on the OmniBook 4100 Recovery CD.
2. Insert the Recovery CD in the CD-ROM drive—or insert the Support Utility disk in the floppy drive.
 3. Reboot the computer. If you are using the Recovery CD, press ESC during reboot to cancel the OmniBook screen, ESC to display the boot-device menu, then select the CD-ROM drive as the boot device.
 4. When prompted, select “Create Hibernate Partition.”

We recommend that you create a partition the same as the default option.

Creating a Hibernate Partition—OmniBook 4150 Series

1. Plug in the ac adapter.
2. Insert the *Recovery CD* in the CD-ROM drive.
3. Shut down and restart the computer—when you see the HP logo, press ESC two times.
4. Select the CD-ROM drive as the boot device.
5. When the Recovery CD dialog box appears, follow the displayed instructions. Accept the recommended partition size. If you install the factory software, the recovery process can take up to 10 minutes.

If you want to create the Hibernate partition without installing the factory software, click Advanced and select the option to not install the operating system. If you intend to install Windows NT, you should choose the FAT16 option or the Hibernate-only option.

Note: If, instead, you see an MS-DOS menu of options, select “Recover...” to create the Hibernate partition and install the factory software, which can take up to 60 minutes. Or select “Create Hibernate Partition” to not install the software. Accept the recommended partition size.

6. When prompted to reboot the computer, press CTRL+ALT+DEL and follow any displayed instructions.

Replacing Small Parts (User-Replaceable)

The following small parts are user-replaceable.

Table 2-6. Replacing Small Parts (User-Replaceable)

Part	Replacement Procedure
Docking Doors	Open each door and flex the door until one side tab releases. To replace, see the picture on page 2-28.
Feet	Insert a small flat-blade screwdriver under the foot and pry it loose. To replace, firmly press the adhesive side of the foot into the recess.
Hinge Cover, Left	With the display lid fully open, push back on the bottom edge of the hinge cover until it unsnaps, then work it loose and lift it off. To install, make sure the front and back tabs snap into the case.
Hinge Cover, Right	With the display lid closed, push in the bottom of the hinge cover until it unsnaps, then work it loose and lift it off. To install, make sure the front and back tabs snap into the case.
I/O Door	With the door closed, insert a small flat-blade screwdriver behind the door from below. Flex the door until one side tab releases. It helps to press in lightly on the ends of the door. To install, keep the icons on the door toward the top.
Pointing Stick Cap	Pull the cap off the pointing stick.
RAM/BIOS Cover	On the bottom of the unit, remove the two screws from the RAM/BIOS cover and remove the cover.
VGA Connector Cover	With the display closed, push up on the connector cover and down on the bottom case until the lower tabs release. To install, insert the top tabs into the strip cover, then push up on the cover and down on the bottom case until you can insert the lower tabs.

Removing the Keyboard

(HP Authorized Service Providers Only)

Required Equipment

- Small Phillips screwdriver.
- Probe or tweezers.

Removal Procedure

1. Unplug the ac adapter, if present, and remove the battery.
2. On the bottom of the unit, remove the seven “K” screws from the bottom case.
3. Insert your small finger into the PCMCIA opening and push up the top of the keyboard—or you can lift it from above using a thin flat-blade screwdriver. After lifting the back edge slightly, slide the keyboard toward the back until the front-left corner is free.
4. With the display tilted only slightly back, lift the front of the keyboard and lean it back against the display. Be careful not to scratch the display or pull on the cables.
5. Release the pointing stick flex cable from the VGA PCA.
6. Release the keyboard flex cable from the VGA PCA.

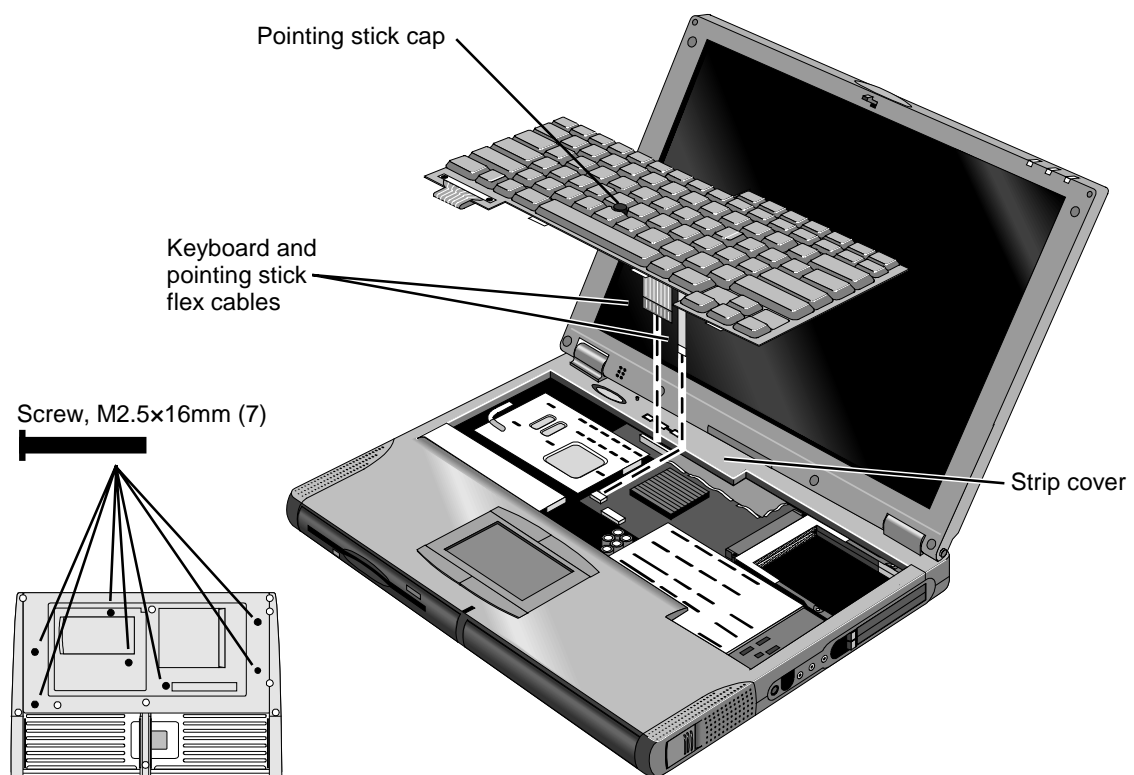

Figure 2-5. Removing the Keyboard

Note

For an OmniBook 4100 with a serial number between TW82000000 and TW83599999, if the date code on the bottom of the keyboard is "828", replace the keyboard. (Service note 4100-02.)

F1460 and F1462 keyboards are not compatible with 4150B models. F1649 keyboards are compatible with all models. See the table on page 5-6 for part numbers.

Reassembly Notes

- To connect the larger keyboard flex cable, lay the keyboard flat on the top case slightly forward of its normal position. To connect the smaller pointing stick flex cable, tip up the keyboard against the display.

Caution

After connecting the keyboard and pointing stick flex cables, lean the keyboard forward and tuck the excess length of the keyboard flex cable under the strip cover behind the keyboard. If a stiffener tab is present on the larger cable, make sure its free end lays toward the front of the case—so the tab is not under the strip cover. *Check the cable again after lowering the keyboard into its final position.*

Hint

On the bottom case, the holes for the keyboard screws are marked by "K". The hole recesses have flat bottoms for the 16-mm T-head screws (not tapered as for longer flathead screws).

Removing the Display Assembly

(HP Authorized Service Providers Only)

Required Equipment

- Small Phillips screwdriver.

Removal Procedure

1. Unplug the ac adapter, if present, and remove the battery.
2. On the back of the unit, lift up on the VGA connector cover above the VGA port and unsnap it from the case.
3. Remove the screw above the VGA port.
4. Remove the four “D” screws from the bottom case.
5. Open the display about 90 degrees, then lift off and lay back the combined top-case strip cover and display assembly. Do not lose the two springs from the bottom case.
6. Remove the two screws from the LCD flex cable end and unplug the cable.

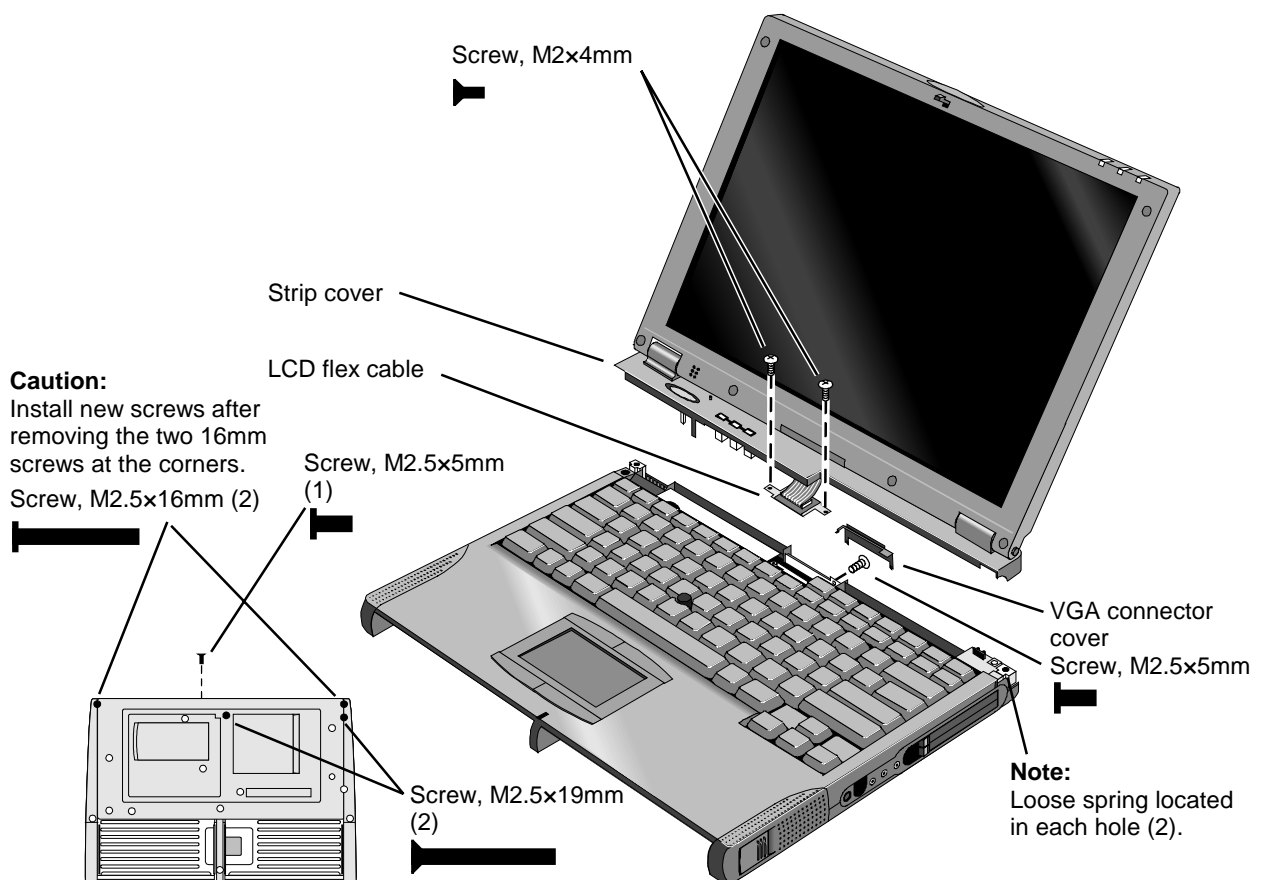

Figure 2-6. Removing the Display

Reassembly Notes

- Before installing the display assembly, make sure a grounding spring is present in each hole at the back corners of the left and right frames.

Caution

Install new screws for all screws you remove that hold the display hinges. Otherwise, the hinges could loosen over time.

Hint

- While attaching the LCD flex cable to the base, rest one corner of the display on the bottom case.
- On the bottom case, the holes for the display screws are marked by "D". The hole recesses have flat bottoms for the 16-mm T-head screws and tapered bottoms for the longer 19-mm flathead screws.

Removing the LCD Module

(HP Authorized Service Providers Only)





Note

The exact details for removing the LCD module depend on the type of module. Some details may differ from those described in this section.

See the table below for information about matching components for different types of LCD modules.

Table 2-7. Display Component Compatibility

LCD Type* OmniBook Model	13" Samsung	14" LG		14" IBM74*		14" IBM74E*
	4100	4100	4150†	4100	4150†	4150†
Bezel, display	F1460-60969	F1460-60967	F1629-60909	F1462-60927	F1629-60919 or F1660-60911	
Cable, LCD flex	F1460-60975	F1460-60981		F1629-60915		
Cable, LED strip	F1460-60972			F1629-60916		
Case, display	F1460-60970	F1460-60968				
Kit, display case (latch...)	F1460-60971					
Kit, LCD (brackets, shield...)	F1460-60974	F1460-60980		F1629-60932		F1640-60909
LCD module	F1460-60908	F1440-60905		F1629-60912		F1640-60908
PCA, inverter	F1460-60917	F1460-60918	F1629-60908	F1629-60917		
PCA, LVDS	F1460-60914	F1460-60916	F1629-60907	F1462-60926	F1629-60918	
PCA, VGA	F1460-60906		F1629-60903	F1460-60906	F1629-60903	

LCD Type* OmniBook Model	13" Hyundai	14" LG*	14" IBM74E	14" IBM76*	14" CPT
	4150B	4150B	4150B	4150B	4150B
Bezel, display	F1655-60915	F1660-60911			
Cable, LCD flex	F1660-60922	F1660-60913	F1660-60921	F1660-60913	F1660-60920
Cable, LED strip	F1629-60916				
Case, display	F1460-60970	F1460-60968			
Kit, display case (latch...)	F1460-60971				
Kit, LCD (brackets, shield...)	F1660-60919	F1660-60915	F1640-60909	F1660-60915	F1660-60918
LCD module	F1655-60920	F1660-60929	F1640-60908	F1660-60928	F1660-60930
PCA, inverter	F1460-60917	F1660-60912	F1660-60924	F1660-60912	
PCA, LVDS	(none)	(none)	(none)	(none)	(none)
PCA, VGA (with switch settings)	F1660-60908 	F1660-60908 	F1660-60908 	F1660-60908 	F1660-60908 

* To identify the type of LCD module, see the marking printed on the LCD flex cable where it plugs into the base—it may be on the top or bottom of the cable.

For an OmniBook 4150B with an LG or IBM76 LCD module, if the marking on the cable is not certain, see the switch settings on the VGA PCA to identify the module.

For an OmniBook 4150† with an IBM LCD module, the IBM74 has a shield with a solid back, and the IBM74E has a shield with a mylar-covered opening across the back.

† Models called 4150† in this manual have no marking in the serial number, whereas models called 4150B have 4150 B after the serial number.

Required Equipment

- Small Phillips screwdriver.
- Pointed knife or probe.

Removal Procedure

1. Unplug the ac adapter, if present, and remove the battery.
2. Remove the display assembly and strip cover from the unit (page 2-11).
3. On the display bezel, remove the upper and lower screw covers (using a pointed knife or probe), then remove the six screws.
4. At the bottom of the display, lift up the inner edge of the bezel near both hinges until it unsnaps—be careful to keep the end caps. Then at one side of the display, use your fingers to gently pull the display bezel *outward*, toward the edge of the case, until the snaps release. When one side is free, repeat along the opposite side—until only the top edge is attached.
5. Now lift the bottom edge about 5 cm and press *inward* along the top edge until the snaps release and the bezel lifts off.
6. Remove the two screws holding the LCD brackets and hinges near the bottom corners of the display case. Remove the combined hinges and strip cover.
7. On the plastic cable holder, unsnap the cover.
8. If present, unplug the flex cable that wraps around the inverter PCA to the left of the cable holder.
9. Unplug the three cables from the inverter PCA—raise the PCA out of the case, if necessary. Remove the PCA.
10. Slide the LCD module and brackets toward the bottom of the case. When the slots in the brackets clear the tabs in the case, lift out the LCD module—the LED strip cable is still in the display case.
11. If the LED strip cable is held by the LCD bracket, place the LCD module next to the display case and LED strip.
12. Remove the four screws holding the brackets to the LCD module.
13. Separate the LCD module and the shield:
 - You may have to remove one or more pieces of tape.
 - If the flex cable is still attached to the LCD module, unplug the cable.

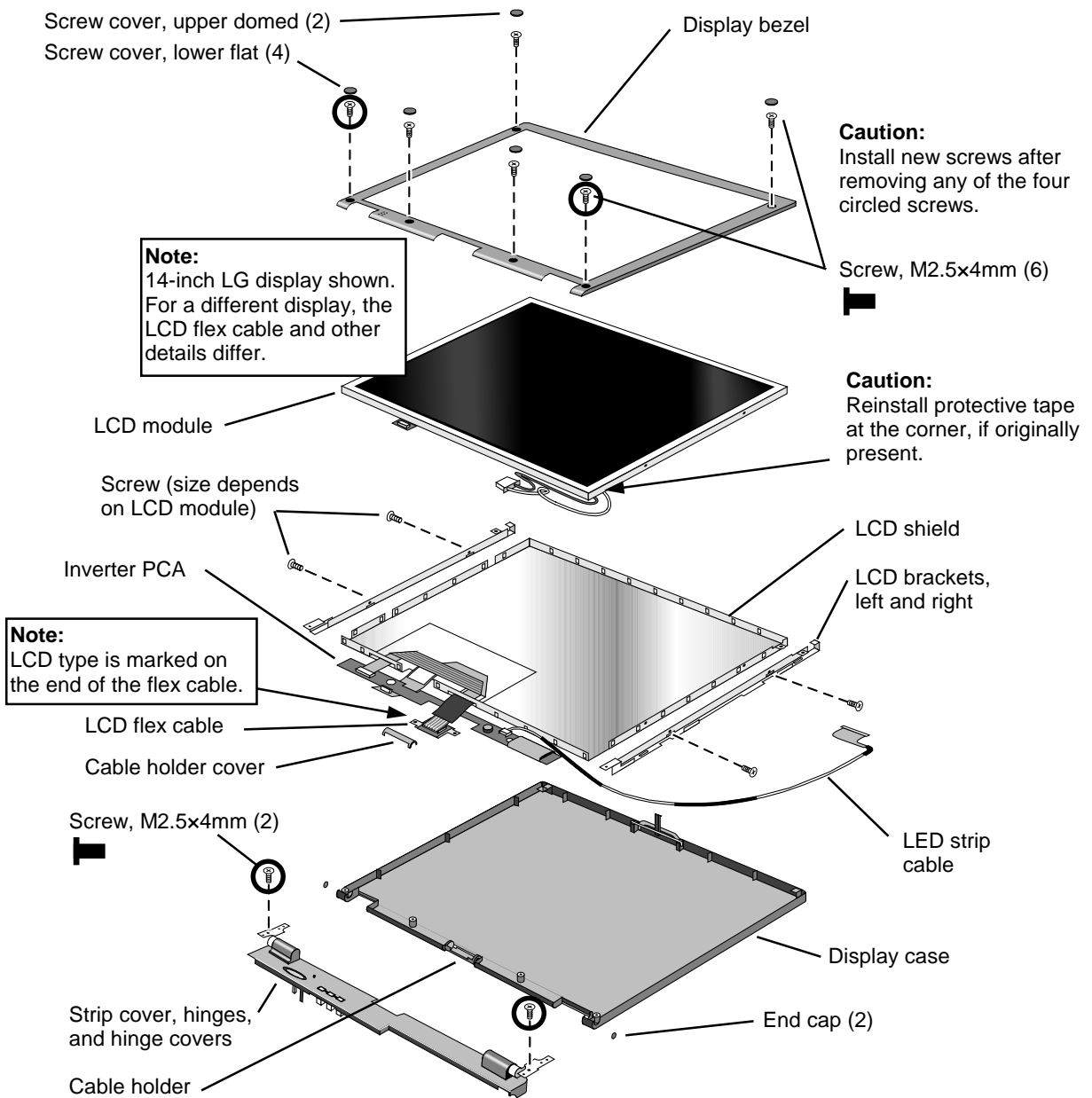

Figure 2-7. Removing the LCD Module

Reassembly Notes

Caution

- Be sure to replace the LCD module or other display components with compatible parts. Components may be damaged if compatible parts are not used. See the table on page 2-13.
- At the lower-right corner of the LCD, reinstall protective tape if it was present on the original LCD.
- For an OmniBook 4150B, if you install a different type of LCD module, you must set the switches on the VGA PCA according to the type of LCD module. See the table on page 2-13.
- Install new screws for all screws you remove that hold the display hinges. Otherwise, the hinges could loosen over time.

- For an LED strip cable that is routed around the bottom-right corner of the LCD, make sure it is routed through the corner of the LCD bracket.
- Install the inverter PCA *under* the main LCD flex cable.
- The extra length of LCD wires connecting to the inverter PCA is folded back along the PCA.
- Snap in the end caps after the display is assembled.

Caution

At the lower-right corner of the LCD module, be careful the wires are not pinched where they pass next to the LCD bracket. Otherwise, they could be damaged.

Caution

For a 13-inch LCD, make sure the spacers and tape are installed when you assemble the LCD module and LCD shield. Otherwise, LCD quality may be significantly degraded, including noise or discoloration when the display is moved. (Service notes 4100-04, 4100-05.)

Install tape here to hold the cable to the shield.

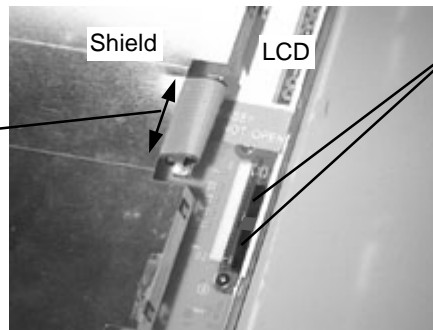

Make sure two rubber spacers are present in the connector recess. If necessary, transfer them from the old LCD or install new spacers.

Note: If one long spacer is present, replace it with two short ones.

Back of 13-Inch LCD and Shield

Removing the Top Case

(HP Authorized Service Providers Only)

Required Equipment

- Small Phillips screwdriver.

Removal Procedure

1. Unplug the ac adapter, if present, and remove the battery.
2. Remove these additional assemblies:
 - Floppy module or other module (page 2-3).
 - Hard disk drive (page 2-5).
 - Keyboard (page 2-9).
 - Display assembly and strip cover (page 2-11).
3. Remove the grounding springs from the back corners of the left and right frames.
4. On each of the front corners of the case, do the following:
 - Slide the module latch slider forward on the side of the case.
 - Slide the speaker cover forward slightly and swing it outward about 2 cm, then pull firmly until it unsnaps from the case. The slider may come off of the module latch.
5. Unplug the touch-pad flex cable from the VGA PCA.
6. On the bottom of the unit, remove the seven unmarked case screws from the front half of the case.
7. Turn the unit face up and lift off the top case—to release the tab at the left side near the PS/2 port, twist up the outer edge of the top case above the PS/2 port.

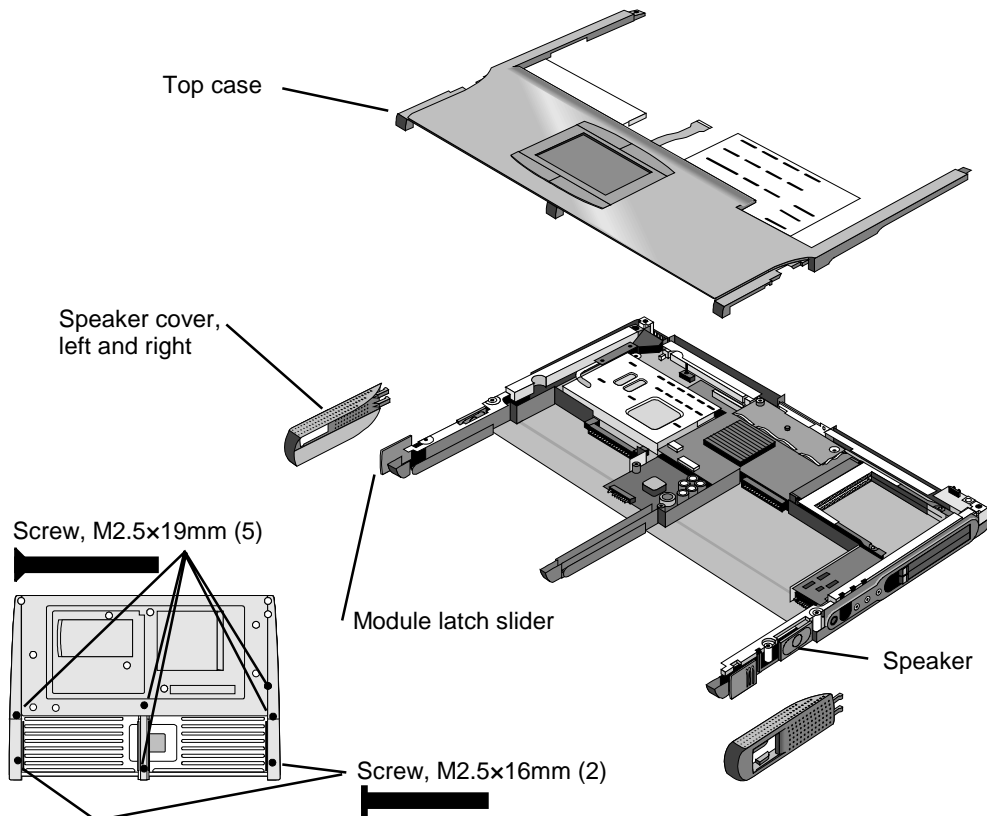

Figure 2-8. Removing the Top Case

Reassembly Notes

- Position the speaker on the pins on the bottom case before you install the speaker cover.
- If the slider came off the module latch, attach it to the latch before you install the speaker cover.

Hint

On the bottom case, the holes for the top case screws are unmarked. The hole recesses have flat bottoms for the 16-mm T-head screws and tapered bottoms for the longer 19-mm flathead screws.

Removing the CPU Module

(HP Authorized Service Providers Only)

Caution

For an OmniBook 4150 Series, do not unnecessarily remove the CPU module from the motherboard. The CPU connector is easily damaged during removal and insertion.

Table 2-8. CPU Component Compatibility

	OmniBook 4100		OmniBook 4150†	
	Pentium (T) 266 MHz	Pentium II (MD) 233-266 MHz	Pentium II (MD) 300 MHz 2-Screw Top Plate	Pentium II (MD,D) 300-400 MHz 5-Screw Top Plate
CPU module	F1440-69102	F1440-69103 (233 MHz) F1440-69104 (266 MHz)	F1440-69016 (300 MHz)	F1440-69016 (300 MHz) F1640-69101 (333 MHz) F1640-69102 (366 MHz) F1640-69103 (400 MHz)
IC, BIOS	F1460-12016	F1460-12007	(not replaceable)	(not replaceable)
PCA, motherboard	F1460-69002	F1460-69004	F1629-69001* F1640-69001*	F1640-69001
Plate, CPU bottom	F1460-60949 (Rev 4)		F1629-80003	
Plate, CPU top	F1460-60951	F1460-60950		F1640-80002
Spacer, CPU	(none)	F1462-80003	(none)	(none)
Thermal pads	5182-5153 (notched) F1463-80001 (large) F1463-80002 (medium) F1463-80003 (small)	5182-5153 (notched) F1462-80004 (square)		For top plate: F1640-60911 (notched)
Heatsink, finned	F1460-60953 (M2 screw) F1629-60913 (M3 screw)		F1629-60913	F1640-60910
Heatsink cover	F1460-60952 (M2 screw) F1629-60914 (M3 screw)		F1629-60914	(none)
* For serial numbers below TW85299999, use F1629-69001. For serial numbers above TW90100000, use F1640-69001.				
† Models called 4150† in this manual have no marking in the serial number, whereas models called 4150B have 4150 B after the serial number.				

	OmniBook 4150B Pentium II (D) 366-400 MHz Heatsink/Top Plate
CPU module	F1640-69102 (366 MHz) F1640-69103 (400 MHz)
IC, BIOS	(not replaceable)
PCA, motherboard	F1660-69009
Thermal pads	For heatsink: F1640-60911 (notched)
Heatsink/top plate	F1660-60903

Required Equipment

- Small Phillips screwdriver.
- OmniBook 4150† CPU removal tool (HP part number T-335665).

Removal Procedure

1. Unplug the ac adapter, if present, and remove the battery.
2. Remove these additional assemblies:
 - Floppy module or other module (page 2-3).
 - Hard disk drive (page 2-5).
 - Keyboard (page 2-9).
3. For an OmniBook that has a 2-screw CPU top plate, remove the screw from the heatsink cover and lift it off the heatpipe. (The figure on page 2-26 shows these and other parts.)
4. Remove the screws holding the CPU top plate (see the picture on page 4-8 for details):
 - For an OmniBook 4150B, remove the five screws from the heatsink/top plate assembly—one at the front-right corner (M2×12mm), two at the left side (M2 with spring), and two at the diagonal corners of processor (M2×3.5mm).
 - For an OmniBook 4150† with a 5-screw CPU top plate, remove the five screws—one at the heatsink (M2×5mm), two at the corners of the CPU housing (M2×14mm), and two at diagonal corners of the CPU module below (M2×3.5mm). (Do not remove the two small screws above the middle of the CPU.)
 - For an OmniBook with a 2-screw CPU top plate, remove the two screws at the corners (M2×14mm).
5. For an OmniBook 4150B, lift off the heatsink/top plate.

For an OmniBook 4150† with a 5-screw CPU top plate, lift off the top plate, carefully detaching the heatpipe end tab from the slot in the fan cover.

Caution

In the next step, follow these precautions to prevent damage to the CPU connectors:

- Do not raise the left end higher than the right end during removal.
- **OmniBook 4150B:** Insert a flat, non-metallic blade under the front of the CPU module near the right end. Pry up against the motherboard until the CPU releases. Repeat at the back edge, then lift off the module.
- **OmniBook 4150†:** Use the CPU removal tool to remove the CPU assembly.
 - a. Hold the tool so the large notch is toward the front of the computer.
 - b. Hold the hooked arm of the tool just to the right edge of the right tab on the top plate. If the top plate has been removed, hold the arm about 4 mm (1/8 inch) to the right of the hook on the bottom plate.
 - c. Hook the hooked arm under the lower-back edge of the CPU assembly (#1) next to the right tab.
 - d. Lower the front arm of the tool so it straddles the connector housing on the motherboard (#2).
 - e. Pull the tool handle toward the front to lift out the assembly (#3). Then remove the tool from the assembly.

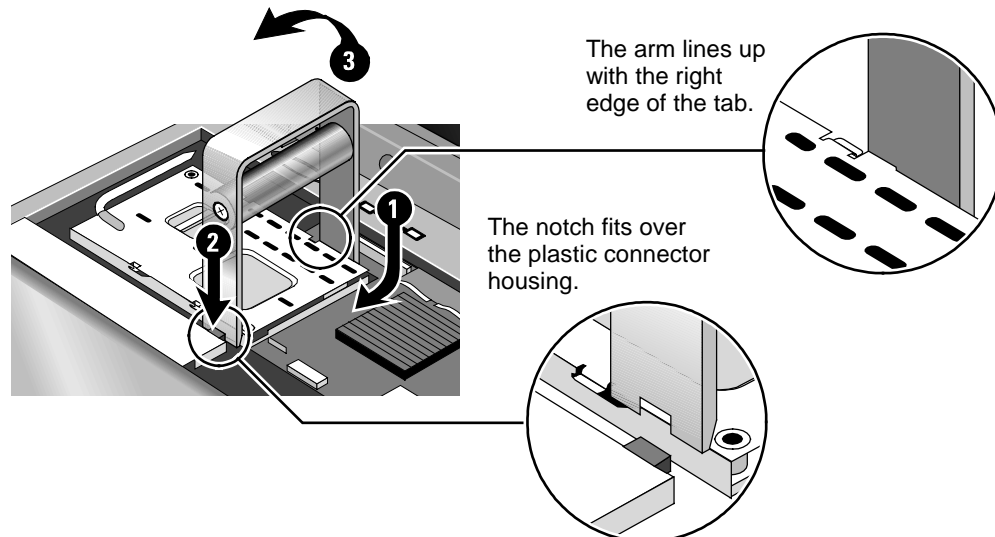

Figure 2-9. Removing the CPU (OmniBook 4150†)

- **OmniBook 4100:** To remove the CPU assembly, lift firmly on the back edge of the bottom plate near the right corner. This requires firm force. After the back edge releases, lift off the assembly.

To reinstall the CPU assembly, see the precautions under “Reassembly Notes.”

6. Remove the complete CPU assembly so it unplugs from the motherboard—see the caution above.
7. If necessary, slide off the top plate, then remove the CPU module from the bottom plate.

Note

For an OmniBook 4100 with a serial number below TW84099999, if the CPU bottom plate has a revision number less than “Rev 4”, replace the bottom plate with one that is “Rev 4” or higher. (Service note 4100-03.)

Reassembly Notes

- For an OmniBook 4100 or 4150†, before installing the CPU module, assemble it into the bottom plate. For a 2-screw CPU top plate, attach the top plate to the assembly—do not attach a 5-screw top plate before installing the assembly. Then install the assembly on the motherboard. See the following caution.

Caution

Install or replace CPU module thermal pads that are missing or damaged. Do not reuse a notched CPU pad on a new CPU module. See the figure following this caution.

- **OmniBook 4150B:** Align the front-right corner of the CPU module and *gently* lower it onto the connector. Press down on the CPU module until it seats, as described below.
- **OmniBook 4150†:** Carefully remove the CPU assembly—the contacts on the CPU connectors are easily damaged.
 - a. Align the front-right corner of the CPU assembly correctly and *gently* lower the assembly onto the connector.
 - b. Place your fingers on top of the CPU assembly above the front and back ends of the connector (#2 and #1). *Do not push at other locations.*
 - c. Press firmly at the back end (#1) while holding down the front—until the back engages.
 - d. Then press down the front down (#2) while holding the back.
 - e. Press firmly until the CPU assembly seats in the connector—you should feel a slight click.

Hold both edges.
Push down one
edge at a time.

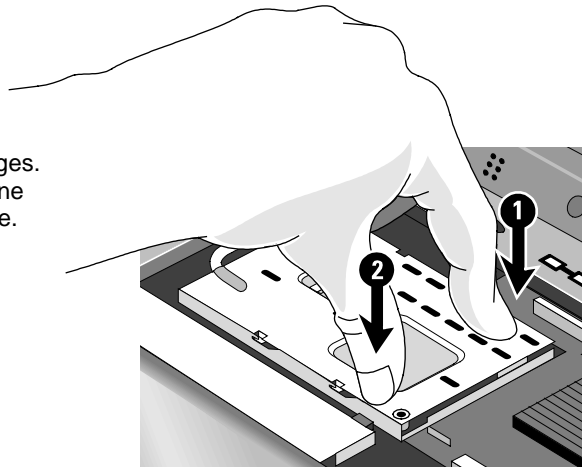

Figure 2-10. Inserting the CPU (OmniBook 4100/4150†)

- **OmniBook 4100:** Keep the CPU assembly flat while installing it. Press it down above the connectors at the right end. Otherwise, you could damage the connectors.

Before installing the screws, make sure the CPU assembly is fully seated so the bottom plate is touching the motherboard. Otherwise, you could strip the screws.

Install the two screws in diagonally opposite corners of the top plate.

- For an OmniBook 4150† with a 5-screw CPU top plate, install the top plate after installing the bottom plate and CPU. The tab on the top plate heatpipe must first be slipped into a slot under the fan cover, as the top plate is lowered into position on the CPU.
- If you removed conductive tape grounding straps from the CPU top plate, install them again.

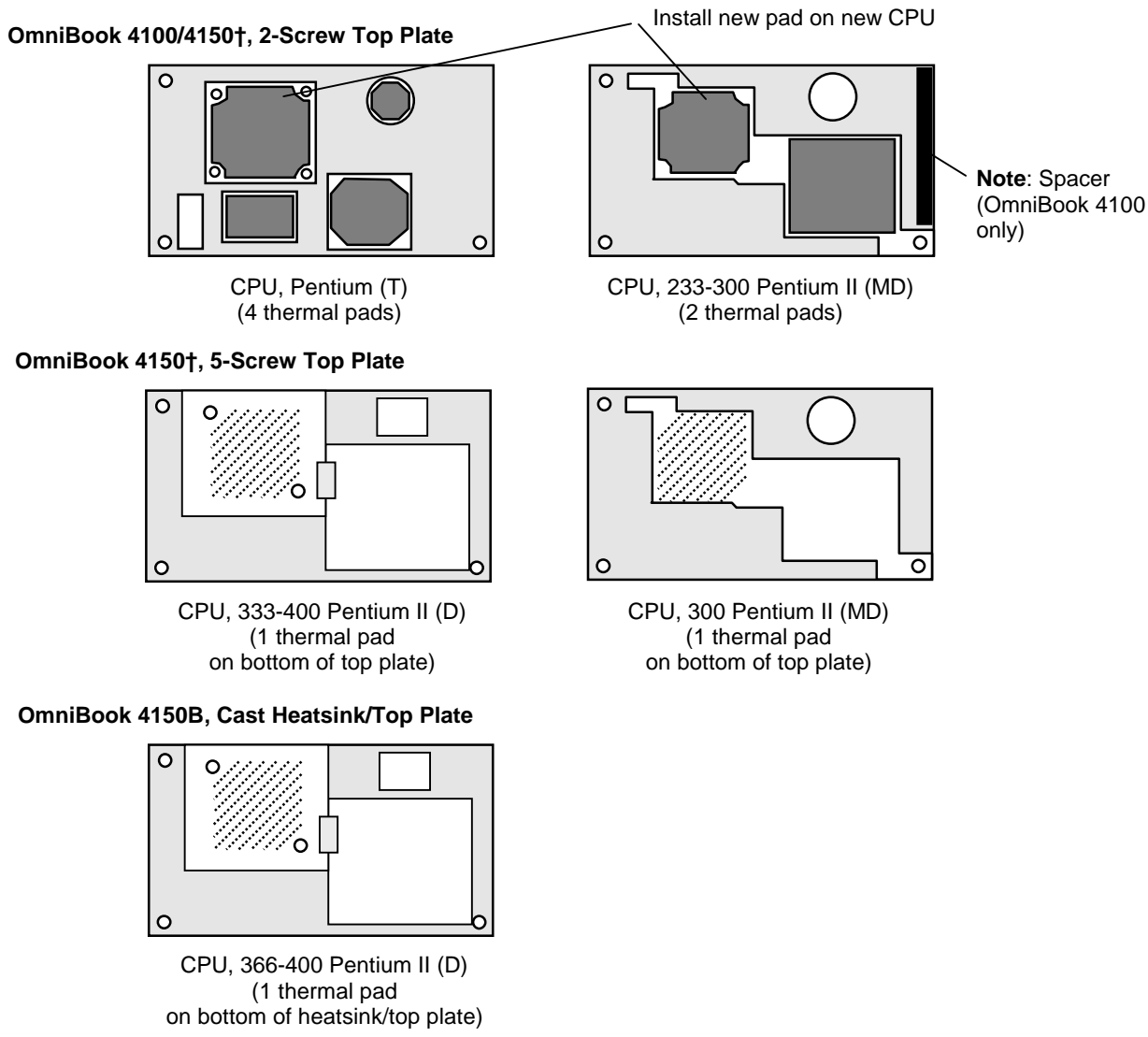

Figure 2-11. Positioning Thermal Pads

Removing the Motherboard or Bottom Case

(HP Authorized Service Providers Only)

Required Equipment

- Small Phillips screwdriver.
- 5-mm hex driver (or 3/16 inch).
- OmniBook 4150 CPU removal tool (HP part number T-335665).

Removal Procedure

1. Unplug the ac adapter, if present, and remove the battery.
2. Remove these additional assemblies:
 - Floppy module or other module (page 2-3).
 - Hard disk drive (page 2-5).
 - Keyboard (page 2-9).
 - Display assembly (page 2-11).
 - Top case (page 2-16).
3. Remove the complete CPU assembly—see page 2-19 for detailed precautions and instructions.
4. On the back of the case, use a 5-mm hex driver to remove the two standoffs from the VGA connector.
5. Lift the front of the VGA PCA to unplug the PCA, then slide it out of the case. (If an LVDS PCA is present, it is attached.)
6. Remove the screw from the IR PCA and lift the PCA off the frame. Unplug the IR cable from the motherboard.

7. Unplug the fan cable from the motherboard.
8. On the left frame, remove the screw that holds the plastic heat exchange cover. On an OmniBook 4150B, remove the second screw from the fan. Lift off the cover and fan – they are a single assembly on the OmniBook 4150B.
9. On the left frame, remove the screw that holds the frame to the motherboard, then lift out the frame.
10. Lift out the side air vent cover. If a finned heatsink is present at the left side of the case, lift it out.
11. On the right frame, remove the two screws that hold the frame to the case, then lift out the frame.
12. Remove the screw holding the motherboard at the back-right corner.
13. Unplug the DC-DC PCA from the right side of the motherboard.
14. Lift the front-right corner of the motherboard and remove the audio jack cover from the case.
15. Unplug the audio jack PCA from the motherboard. The metal shield comes off with the PCA.
16. Note the routing of the speaker wires. Then unplug the speaker wires from the motherboard.
17. Remove the two screws from the RAM/BIOS cover and remove it from the bottom of the unit.

Hint

In the next step, while removing the motherboard, reach through the RAM opening and separate the case from the PCA. Otherwise, the PCA sticks in the bottom case.

18. Lift the front edge of the motherboard until it clears the hard drive compartment in the bottom case and frees itself from the bottom case. Then slide the PCA forward and lift it out.

The docking doors may come out while you are removing the motherboard.

Note:
 For an OmniBook 4150† with a 5-screw CPU top plate or an OmniBook 4150B, you must remove the top plate before removing the CPU assembly—see the steps on page 2-19. The CPU and heatsink parts (*) differ from those shown below.

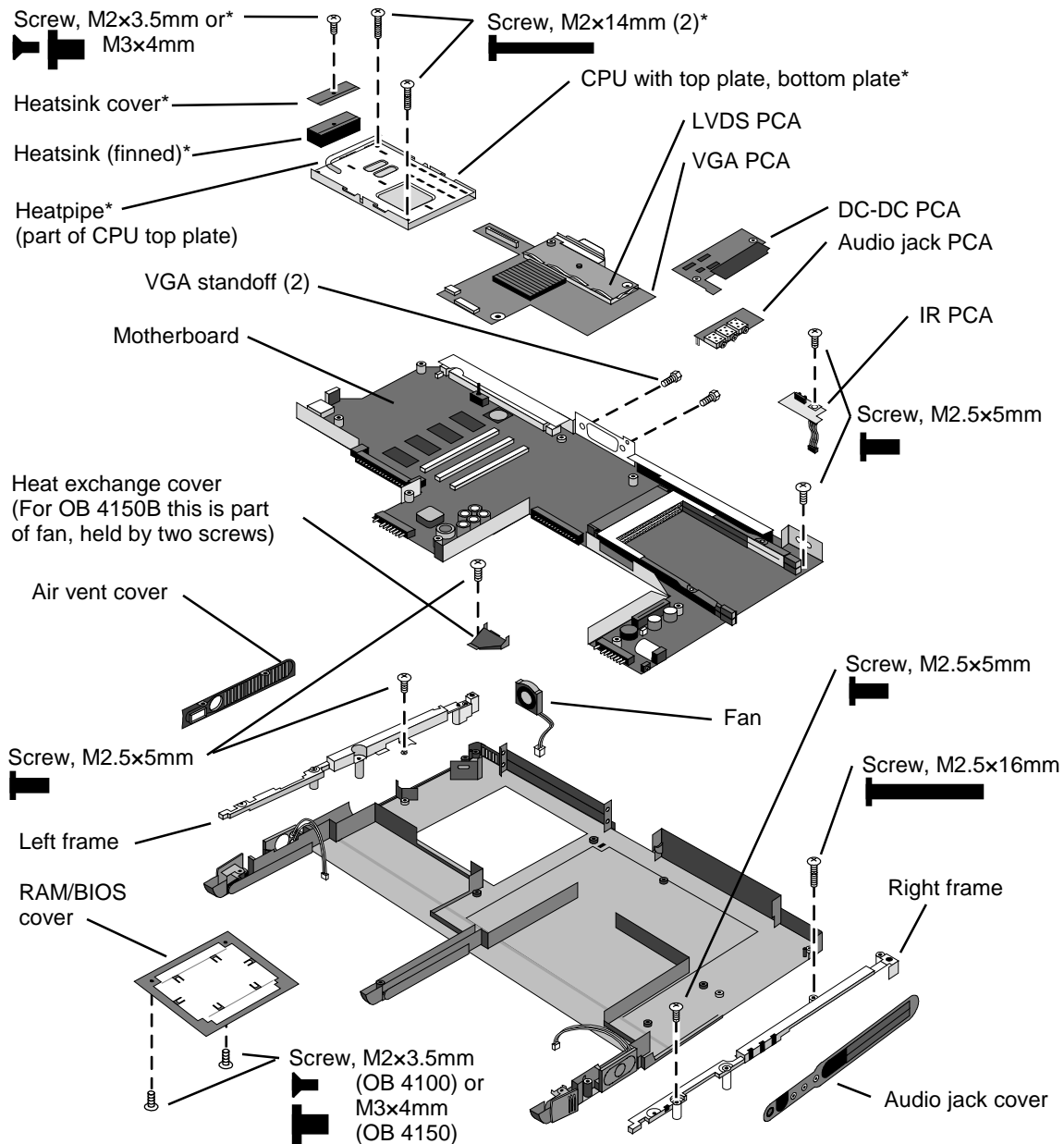

Figure 2-12. Removing the Motherboard

Reassembly Notes

Note: Installing a New Motherboard

- **Caution:** Replace the motherboard with one that is compatible with the OmniBook model and CPU module—see the table on page 2-19.
- If any RAM boards are present, transfer them from the old motherboard to the new one:
- Reprogram the BIOS IC—see the note below.
- Store the serial number electronically in the new motherboard—see the steps below.

Note: Installing a New Bottom Case

- Transfer these parts from the old bottom case to the new one:
 - I/O door, docking doors, and module latches (see the figures below).
 - Speakers.
- Install a new regulatory/business card label.
- Transfer the old serial number label and install a new overlay—or create a new serial number label using the steps below.
- Route the speaker wires so they do not get pinched or block screw holes.
- When you install the audio jack PCA, the metal shield goes under the motherboard. If the shield comes off the PCA, you can install the shield after you install the PCA.
- For an OmniBook 4100 or 4150†, route the fan wires at the bottom of the opening next to the motherboard.
- When attaching the IR PCA to the right frame, make sure the PCA is parallel with the back of the case.
- For an OmniBook 4150† with serial number TW924xxxxx, install a rubber VGA spacer on the top of the PCA at the front-left corner. (Service note 4150-11.)

Caution

See “Removing the CPU Module” on page 2-19 for detailed precautions and instructions about installing the CPU module.

Note

If you installed a new motherboard with a new BIOS IC, the IC contains only enough basic programming to boot the OmniBook. After installing the motherboard, you must reprogram the IC. Hewlett-Packard prefers that you program the IC with the latest BIOS. You can download it from the OmniBook website (see page vi)—follow the directions provided.

Note: View from inside the case.
Rotate the doors 360° to load the spring.

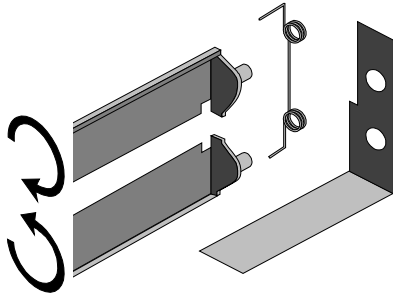

Note: Left latch shown.
Rotate the latch 180° to load the spring.

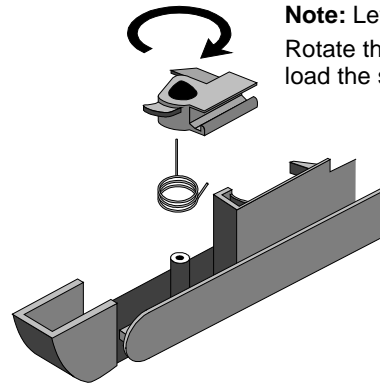

Figure 2-13. Installing Docking Doors and Module Latch

Storing the Serial Number Electronically

1. Exit Windows and boot to a DOS prompt.
2. Run ESN.EXE from one of these sources:
 - On a factory software installation, change to the \Omnibook\Drivers\Hputils directory and type **esn** at the prompt.
 - Otherwise, copy \Omnibook\Drivers\Hputils\Esn.exe from the OmniBook 4100 or 4150 Recovery CD, then run it on the OmniBook.
3. Store the serial number:
 - If you are prompted for the serial number, type the serial number shown on the bottom of the case.
 - If a serial number has already been stored, you must call an HP support center to change it.

Installing a New Serial Number Label

If you do not have a master file that creates serial number labels **with fields for “4150 B” and manufacturing location**, get a copy from the Reseller website (see page vi) under Support/Service in Technical Support Information.

1. Using any PC connected to a laser printer, open the master serial label file, enter the serial number and product number from the old serial label, and print the new label on plain white paper. The new label does not have barcodes.
2. Carefully cut out the new serial label just inside the border and place it into the inner recess in the bottom case. The bottom of the label goes toward the front of the case.
3. While holding the paper label in place, attach a serial label overlay into the outer recess. It covers and protects the serial label.

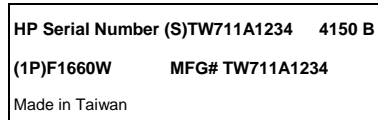

Figure 2-14. Example of Serial Number Label

Removing or Repairing the BIOS IC

(HP Authorized Service Providers Only)

For the OmniBook 4150 Series, the BIOS IC is soldered to the motherboard and is not replaceable:

- If the OmniBook 4150 BIOS IC is defective, the motherboard must be replaced.
- However, if the OmniBook 4150 BIOS IC might only be corrupted, you can repair the BIOS from a Crisis Recovery floppy—see the information below.

Note

A replacement BIOS IC contains only enough basic programming to boot the OmniBook. After installing the IC, you must reprogram it. Hewlett-Packard prefers that you program the IC with the latest BIOS. You can download it from the OmniBook website (see page vi)—follow the directions provided.

Required Equipment

- Small Phillips screwdriver.
- IC (PLCC) removal tool (similar to OK Industries EX-5).

Removal Procedure

Caution

Remove all power before removing or installing the BIOS IC. Otherwise, the IC could be damaged.

1. Unplug the ac adapter, if present, and remove the battery.
2. On the bottom of the unit, remove the two screws from the RAM/BIOS cover and remove the cover.
3. Use an IC removal tool to remove the BIOS IC from its socket.

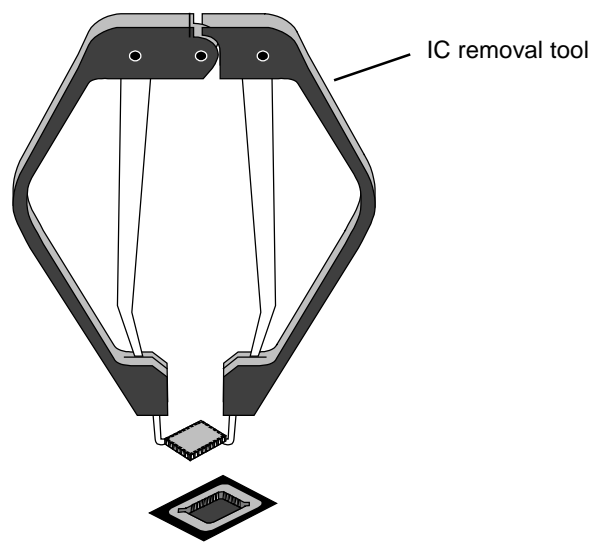

Figure 2-15. Removing the BIOS IC

Reassembly Notes

Caution

- Replace the BIOS IC with one that is compatible with the CPU module—see the table on page 2-19.
 - Align the IC with the slot in the socket. The IC is keyed to fit correctly. If you insert the IC backward, the IC or motherboard could be damaged.
- Press down firmly on the IC with your thumb to ensure a proper connection.
 - Reprogram the IC by programming the BIOS—see the note above.

Repairing the BIOS (OmniBook 4150 Series Only)

If you do not have a BIOS Crisis Recovery floppy, download the package from the Reseller website (see page vi) under Product Support Information in the Service and Support Library. Follow the instructions for creating the floppy.

Caution

Make sure you are using the correct BIOS Crisis Recovery floppy for the OmniBook model you are repairing. The program does not verify the OmniBook model, so you could install the wrong BIOS image.

1. Insert the BIOS Crisis Recovery floppy in the floppy drive.
2. In many situations, you can skip this step—especially if the computer previously displayed a BIOS checksum error.

If the computer does not boot from the BIOS Crisis Recovery floppy, try plugging the boot-block jumper into the OmniBook parallel port, then go to the next step. See the wiring diagram below.

3. Turn on the computer and allow it to boot from the floppy disk.

If the computer does not turn on at all, do the following steps to boot from the floppy disk:

- Unplug the ac adapter.
- Press and hold Fn+B.
- Plug in the ac adapter.
- Release Fn+B.

4. Wait while the BIOS is reprogrammed—the display is blank for a minute or more while this happens.

If you plugged in a boot block jumper, unplug it before the computer automatically reboots.

5. After the BIOS is repaired and reprogrammed, check the BIOS version to see whether it is the latest version. If necessary, reprogram the BIOS IC—see the note at the beginning of this topic.

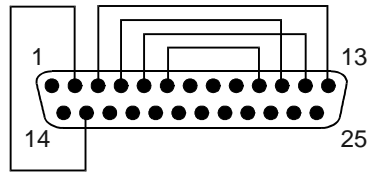

Figure 2-16. Boot-Block Jumper

Removing Other Components

(HP Authorized Service Providers Only)

Required Equipment

- Small Phillips screwdriver.
- Pointed knife or probe (for display components).
- 5-mm hex driver (or 3/16 inch) (for bottom case components).

Removal Procedure

1. Unplug the ac adapter, if present, and remove the battery.
2. Remove the additional assemblies and follow the special steps indicated in the tables below. Components are separated into these groups:
 - Display components (below).
 - Top case components (page 2-32).
 - Bottom case components (page 2-33).

Table 2-9. Removing Display Components

Component	Removal Procedures	Additional Steps (See figure on page 4-7)
Cable Holder (part of display case kit)	Display (page 2-11).	<ol style="list-style-type: none"> 1. Remove the display bezel (page 2-13). 2. Unsnap the cover of the cable holder. 3. Use a flat-blade screwdriver to pry the display case and release the cable holder. <p>Reassembly Notes: Install the holder so the tabbed side is toward the bottom of the display case.</p>
Display Bezel	Display (page 2-11)	<p>Remove the display bezel (page 2-13).</p> <p>Caution: Use compatible parts (page 2-13).</p>
Display Case	Display (page 2-11).	<p>Remove the LCD module and brackets from the case, but do not disassemble the module (page 2-13).</p> <p>Reassembly Notes: Transfer the display latch and cable holder from the old display case.</p> <p>Caution: Use compatible parts (page 2-13).</p>

Component	Removal Procedures	Additional Steps (See figure on page 4-7)
Display Latch (part of display case kit)	Display (page 2-11).	<ol style="list-style-type: none"> For a 13-inch display, do not remove the LCD module, but remove the display assembly and bezel (page 2-13). For a 14-inch display, remove the LCD module and brackets from the case, but do not disassemble the module (page 2-13). Use a flat-blade screwdriver or probe to release one end of the latch spring. Swing the latch into the display case, then lift it out of its holders.
End Cap	Display (page 2-11).	<ol style="list-style-type: none"> Remove the display bezel (page 2-13). Lift out the end cap.
Hinge	Display (page 2-11).	<ol style="list-style-type: none"> Remove the display bezel (page 2-13). Remove the hinges and strip cover from the LCD brackets, then unsnap the hinge covers.
Inverter PCA	Display (page 2-11).	<ol style="list-style-type: none"> Remove the display bezel (page 2-13). On the plastic cable holder, unsnap the cover. Unplug all cables attached to or holding the inverter PCA. Lift up the PCA if necessary. <p>Reassembly Notes: Attach cables with tape as in the original unit.</p> <p>Caution: Use compatible parts (page 2-13).</p>
LCD Brackets (part of LCD kit)	Display (page 2-11). LCD module (page 2-13).	Caution: Use compatible parts (page 2-13).
LCD Flex Cable	Display (page 2-11). LCD module (page 2-13).	<p>Remove the LCD flex cable from the shield.</p> <p>Reassembly Notes: Attach the cable to the shield as in the original unit.</p> <p>Caution: Use compatible parts (page 2-13).</p>
LCD Module	See page 2-13.	
LCD Shield (part of LCD kit)	Display (page 2-11). LCD module (page 2-13).	<p>Remove the LCD flex cable from the shield.</p> <p>Caution: Use compatible parts (page 2-13).</p>
LED Strip Cable	Display (page 2-11).	<ol style="list-style-type: none"> Remove the LCD module and brackets from the display case, but do not disassemble the module (page 2-13). If necessary to free the LED cable, remove the right LCD bracket. <p>Reassembly Notes: Make sure the LED cable is routed through the bottom-right corner of the LCD bracket.</p>
Strip Cover (Top Case)	Display (page 2-11).	Unsnap the strip cover from the hinge covers.

Table 2-10. Removing Top Case Components

Component	Removal Procedures	Additional Steps
Keyboard	See page 2-9.	
Strip Cover	Display (page 2-11).	Unsnap the strip cover from the hinge covers.
Top Case	See page 2-16.	

Table 2-11. Removing Bottom Case Components

Component	Removal Procedures	Additional Steps (See figures on pages 4-2, 4-8)
Air Vent Cover	Plug-in module (page 2-3). Hard drive (page 2-5). Keyboard (page 2-9). Display (page 2-11). Top case (page 2-16).	<ol style="list-style-type: none"> 1. Remove the screw from the plastic heat exchange cover and remove the cover. 2. Lift off the fan and move it aside. 3. For a 2-screw CPU top plate, remove the screw from the heatsink cover and remove the cover. 4. Remove the 2 or 5 screws from the CPU top plate and remove the plate. 5. Remove the screw holding the left frame to the motherboard and lift off the frame. 6. Lift out the air vent cover.
Audio Jack Cover	Plug-in module (page 2-3). Hard drive (page 2-5). Keyboard (page 2-9). Display (page 2-11). Top case (page 2-16).	<ol style="list-style-type: none"> 1. Remove the screw from the IR PCA and move the PCA aside. 2. Remove the two screws from the right frame and remove the frame. 3. Lift the front-right corner of the motherboard slightly and remove the audio jack cover.
Audio Jack PCA	Plug-in module (page 2-3). Hard drive (page 2-5). Keyboard (page 2-9). Display (page 2-11). Top case (page 2-16).	<ol style="list-style-type: none"> 1. Remove the screw from the IR PCA and move the PCA aside. 2. Remove the two screws from the right frame and remove the frame. 3. Unplug the DC-DC PCA. 4. Unplug the audio jack PCA. <p>During installation, the metal shield goes under the motherboard.</p>
BIOS IC	See page 2-28.	
Bottom Case	See page 2-19.	
CPU Bottom Plate	Keyboard (page 2-9). CPU module (page 2-13).	<p>Reassembly Notes: For an OmniBook with a 2-screw top plate, assemble the CPU module, top plate, and bottom plate before installing them on the motherboard.</p> <p>For an OmniBook 4150† with a 5-screw top plate, assemble the only CPU module and bottom plate before installing them on the motherboard.</p>
CPU Module (MMO)	See page 2-13.	
CPU Top Plate Note: For the OmniBook 4150B, see “Heatsink/Top Plate” below.	Keyboard (page 2-9).	<ol style="list-style-type: none"> 1. For an OmniBook 4150† with a 2-screw top plate, remove the screw from the heatsink cover and lift it off the heatpipe. 2. Remove the 2 or 5 screws holding the CPU top plate. 3. Remove the top plate. <p>Caution: Replace the top plate with one that is compatible with the CPU module—see the table on page 4-3.</p> <p>Caution: Install conductive tape grounding straps and conductive pads on top of the top plate—just as on the original top plate.</p> <p>Caution: For an OmniBook 4100, install a square top-plate spacer on top of the top plate at the right-rear corner. (Service note 4100-03C.)</p>

Component	Removal Procedures	Additional Steps (See figures on pages 4-2, 4-8)
DC-DC PCA	Plug-in module (page 2-3). Hard drive (page 2-5). Keyboard (page 2-9). Display (page 2-11). Top case (page 2-16).	<ol style="list-style-type: none"> 1. Remove the screw from the IR PCA and move the PCA aside. 2. Remove the two screws from the right frame and remove the frame. 3. Unplug the DC-DC PCA.
Fan Caution: Do not spin the fan blade with your finger. Pressure on the fan blade can damage the bearings.	Keyboard (page 2-9). Display (page 2-11).	<ol style="list-style-type: none"> 1. Unplug the fan cable from the motherboard. 2. Remove the screw from the plastic cover. On an OmniBook 4150B, remove the other screw holding the fan. 3. Lift out the cover and fan - they are a single assembly on an OmniBook 4150B. Reassembly Notes: For an OmniBook 4100 or 4150†, route the fan wires at the bottom of the opening next to the motherboard.
Frame, Left	Plug-in module (page 2-3). Hard drive (page 2-5). Keyboard (page 2-9). Display (page 2-11). Top case (page 2-16).	<ol style="list-style-type: none"> 1. Remove the 1 or 2 screws holding the heat exchange cover/fan. 2. Lift off the cover/fan and move them aside. 3. For a 2-screw CPU top plate, remove the screw from the heatsink cover and remove the cover. 4. Remove the 2 or 5 screws from the CPU top plate and remove the top plate. 5. Remove the screw holding the frame to the motherboard and remove the frame.
Frame, Left or Right	Plug-in module (page 2-3). Hard drive (page 2-5). Keyboard (page 2-9). Display (page 2-11). Top case (page 2-16).	<ol style="list-style-type: none"> 1. Remove the screw holding the IR PCA to the frame and move the PCA aside. 2. Remove the two screws holding the frame and remove the frame.
Heatsink Parts (OmniBook 4100/4150†) Caution: For the OmniBook 4100, the finned heatsink and heatsink cover must match the screw size (M2 or M3).	Keyboard (page 2-9). Display (page 2-11).	<ul style="list-style-type: none"> • Heat exchange cover: Remove the screw from the plastic cover and remove it from the frame. • Heatsink cover (present only on an OmniBook with a 2-screw CPU top plate): Remove the screw from the cover and remove it from the heatpipe. • Finned heatsink: Remove the top case (page 2-16). Remove the screw holding the heat exchange cover to the frame and remove the cover. Lift off the fan and move it aside. For a 2-screw CPU top plate, remove the screw and heatsink cover. Remove the 2 or 5 screws from the CPU top plate and remove the top plate. Remove the screw from the left frame and lift off the frame. Then lift out the finned heatsink.
Heatsink/Top Plate (OmniBook 4150B)	Keyboard (page 2-9).	Remove the 5 screws from the heatsink/top plate and lift it off.
IR PCA	Display (page 2-11).	Remove the screw from the IR PCA, then unplug the cable from the motherboard.
LVDS PCA (not present in OmniBook 4150B)	Keyboard (page 2-9). Display (page 2-11).	<p>Use a probe to unplug the LVDS PCA from the VGA PCA.</p> <p>Caution: The LVDS PCA must be compatible with the LCD module. See the compatibility table on page 2-13.</p>

Component	Removal Procedures	Additional Steps (See figures on pages 4-2, 4-8)
Module Latch, Left	Plug-in module (page 2-3). Hard drive (page 2-5). Keyboard (page 2-9). Display (page 2-11). Top case (page 2-16).	<ol style="list-style-type: none"> 1. Remove the 1 or 2 screws holding the heat exchange cover/fan. 2. Lift off the cover/fan and move them aside. 3. For a 2-screw CPU top plate, remove the screw from the heatsink cover and remove the cover. 4. Remove the 2 or 5 screws from the CPU top plate and remove the top plate. 5. Remove the screw holding the frame to the motherboard and remove the frame. 6. Lift off the latch and spring. <p>Reassembly Notes: See the picture on page 2-28.</p>
Module Latch, Right	Plug-in module (page 2-3). Hard drive (page 2-5). Keyboard (page 2-9). Display (page 2-11). Top case (page 2-16).	<ol style="list-style-type: none"> 1. Remove the screw from the IR PCA and move the PCA aside. 2. Remove the two screws from the right frame and remove the frame. 3. Lift off the latch and spring. <p>Reassembly Notes: See the picture on page 2-28.</p>
Motherboard	See page 2-19.	
PCMCIA Socket	Keyboard (page 2-9).	Remove the four screws from the PCMCIA socket and unplug it from the motherboard.
Speaker, Left	Plug-in module (page 2-3). Hard drive (page 2-5). Keyboard (page 2-9). Display (page 2-11). Top case (page 2-16).	<ol style="list-style-type: none"> 1. Remove the 1 or 2 screws holding the heat exchange cover/fan. 2. Lift off the cover/fan and move them aside. 3. For a 2-screw CPU top plate, remove the screw from the heatsink cover and remove the cover. 4. Remove the 2 or 5 screws from the CPU top plate and remove the top plate. 5. Remove the screw holding the frame to the motherboard and remove the frame. 6. Unplug the speaker wires and remove the speaker.
Speaker, Right	Plug-in module (page 2-3). Hard drive (page 2-5). Keyboard (page 2-9). Display (page 2-11). Top case (page 2-16).	<ol style="list-style-type: none"> 1. Remove the screw from the IR PCA and move the PCA aside. 2. Remove the two screws from the right frame and remove the frame. 3. Unplug the DC-DC PCA. 4. Unplug the speaker wires and remove the speaker.
Speaker Cover		<p>On the front corner of the case, slide the latch forward. Then slide the speaker cover forward slightly, swing it outward about 2 cm, then pull firmly until it unsnaps from the case.</p> <p>Reassembly Notes: If the slider came off the latch, attach it to the latch before you install the cover.</p>
Spring, Grounding	Display (page 2-11).	Remove the spring from the hole at the back of the left or right frame.

Component	Removal Procedures	Additional Steps (See figures on pages 4-2, 4-8)
VGA PCA	Keyboard (page 2-9). Display (page 2-11).	<ol style="list-style-type: none"> 1. Unplug the touch-pad cable from the VGA PCA. 2. On an OmniBook 4100 or 4150†, use a probe to unplug the LVDS PCA from the VGA PCA. 3. On the back of the unit, remove the two standoffs from the VGA connector. 4. Unplug the VGA PCA from the motherboard. <p>Caution: For an OmniBook 4150B, you must set the switches on the PCA according to the type of LCD module in the computer—see the table on page 2-13.</p> <p>Reassembly Notes: For an OmniBook 4150† with serial number TW924xxxx, install a rubber VGA spacer on the top of the PCA at the front-left corner. (Service note 4150-11.)</p>
<p>† Models called 4150† in this manual have no marking in the serial number, whereas models called 4150B have 4150 B after the serial number.</p>		

Troubleshooting and Diagnostics

This chapter includes troubleshooting and diagnostic information for testing the functionality of the OmniBook and identifying faulty modules:

- Troubleshooting information
 - Troubleshooting the problem (page 3-2).
 - Verifying the repair (page 3-3).
 - Suggestions for troubleshooting (page 3-4).
- Diagnostic tools
 - OmniBook hardware diagnostic program (page 3-13).
 - Power-on self-test (page 3-20).
 - Sycard PCCtest 450 PC Card (page 3-23).
 - Desktop Management Interface (page 3-23).
 - BIOS Setup utility (page 3-26).

Caution

For an OmniBook 4150 Series model, do not unnecessarily remove the CPU module from the motherboard. The CPU connector is easily damaged during removal and insertion.

Troubleshooting

The suggestions in this section can help isolate and repair the cause of a problem. To ensure quality repair, HP recommends that you follow the basic troubleshooting steps shown in the illustration below.

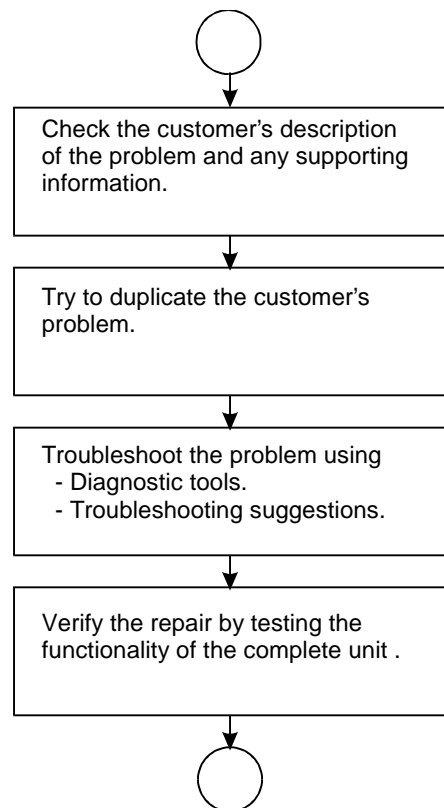

Figure 3-1. Basic Troubleshooting Steps

Troubleshooting the Problem

Record pertinent information about the unit:

- Model and serial number.
- Operating system and version.
- BIOS version.
- Accessories and peripherals used.

Analyze the problem:

- **Observe Symptoms.** Using the customer's information, try to duplicate the problem. Determine how the problem differs from proper behavior. Also, take note of the functions that *do* work properly.

- **Separate Problems.** If there is more than one symptom, separate them into distinct problems.
- **Consider Causes.** Keep in mind possible causes for each problem. Use the diagnostic tools and troubleshooting suggestions to help find possible causes.
 - The OmniBook diagnostic program is the primary troubleshooting tool—it tests most components using automatic and interactive tests. The table on page 3-4 shows how you can use the different diagnostic tools to isolate the cause.
 - The troubleshooting suggestions on page 3-5 include general suggestions for repairing units with certain failure symptoms.

Swapping easily replaced modules with known-good modules is an ideal way to isolate the cause down to the module level. It is rare for more than one module to be responsible for one failure symptom. Therefore, replacement of more than one module for a particular symptom should be the exception rather than the normal expectation.

After replacing a module, it is normal for the unit to be in a confused state and lock up when power is applied. If this occurs, press the system-off button to restart the computer in a known state.

Verifying the Repair

Before returning the repaired unit to the customer, verify the repair by running the following tests:

- **Basic Diagnostic Test.** Run the basic test of the OmniBook diagnostic program (page 3-13).
–and–
- **Function Tests.** Run tests that check the repaired function, such as in the OmniBook diagnostic program (page 3-13).
–and–
- **Failed Tests.** Run any other tests that failed during troubleshooting.

Suggestions for Troubleshooting

Table 3-1. Scope of Diagnostic Tools

Function	OmniBook Diagnostics	Power-On Self-Test	Sycard PCCtest 450	DMI/TopTools (if installed)	BIOS Setup
Bootup		Tests		Describes (SafeTools)	Configures
Processor	Tests (System menu)	Tests		Describes (AssetTools)	
Memory	Tests (Memory menu)	Tests		Describes (AssetTools)	Describes
Batteries				Describes (AssetTools)	
Display	Tests (Video, Mem, User menus)			Describes (AssetTools)	
Hard disk	Tests (IDE menu)	Tests		Describes (AssetTools)	Configures
Floppy drive	Tests (FDD menu)	Tests		Describes (AssetTools)	Describes
Keyboard	Tests (KBD menu)	Tests		Describes (AssetTools)	
Pointer	Tests (Misc menu)			Describes (AssetTools)	Configures
Audio	Tests (System, Misc menus)				Configures
Serial	Tests* (Misc menu)			Describes (AssetTools)	Configures
Parallel	Tests* (Misc menu)			Describes (AssetTools)	Configures
Infrared	Tests† (Misc menu)			Describes (AssetTools)	Configures
PS/2 port	Tests† (KBD, Misc menus)				
USB	Tests† (System menu)			Describes (AssetTools)	
Docking port	Tests (using docks)				
PCMCIA	Tests (Misc menu)		Tests	Describes (AssetTools)	
AC adapter				Status (AssetTools)	
Docking products	Tests ports and internal bus			Status (AssetTools)	Configures
CD-ROM drive	Tests (IDE menu)	Tests (with boot CD)		Describes (AssetTools)	Configures
Other plug-in modules				Describes (AssetTools)	

* The diagnostic test is more thorough if you use a loop-back connector.

† Use an appropriate external device to exercise the port. See the help text for the tests in the menu.

If you can't isolate the cause of a problem using the diagnostic tools, you can use the suggestions in the following table to help find the problem.

Table 3-2. Troubleshooting Suggestions

Symptom	Call Center: Suggestions	Repair Center: Likely Causes	Repair Center: Comments
To help determine likely causes, check to see what replaceable modules are involved in the system function and what roles they play. See the table on page 1-15.			
Startup			
Does not boot on ac or battery	Check the power source. Push system-off button. Unplug the ac adapter and remove all batteries, then reconnect power. Remove any RAM board and try again. Reinsert and try again.	AC adapter. DC-DC PCA. RAM board. CPU module. Motherboard. VGA PCA. LCD module. Hard drive.	For an OmniBook 4100 with serial number below TW84099999, check CPU bottom plate. If plate is less than "Rev 4", replace bottom plate. Also, make sure a square spacer is installed on top of the CPU top plate at the right-rear corner. (Service note 4100-03C.) Check ac adapter. Remove any RAM boards and retry. If power status light does not turn on, reprogram BIOS, replace DC-DC PCA, replace motherboard. If power status light turns on but display remains off, try external monitor. If monitor shows successful boot, replace LCD module. If monitor shows activity but BIOS does not complete, replace CPU module. If monitor is blank, replace VGA PCA, replace CPU module, replace motherboard. If power status light and display turn on, BIOS completes, but OS does not start from hard disk or from floppy drive, replace CPU module, then motherboard. If OS starts from floppy drive, reload hard drive, replace hard drive.
OmniBook 4150 Series model beeps once, spins hard disk, repeats, but does not boot		RAM board (OB 4150 Series).	Make sure at least one RAM board is installed.
Does not boot on battery (boots on ac)	Check battery level on battery LEDs. Check battery contacts. If available, try another battery.	Battery or contacts. DC-DC PCA. Motherboard.	

Symptom	Call Center: Suggestions	Repair Center: Likely Causes	Repair Center: Comments
Does not boot from floppy drive	Check floppy drive contacts. Try using alternate connection (with or without floppy cable). Check boot order in BIOS Setup. Check that floppy boot is enabled in BIOS Setup.	Floppy drive or contacts. Floppy cable. Motherboard.	
Error message such as "Invalid system disk" or "Auto IDE error"	Check for a disk in floppy drive. Remove and reinsert hard drive. Check boot order in BIOS Setup.	Hard drive contacts. Hard drive.	If unit boots from floppy drive, check for corrupt files on hard drive, reload hard drive, replace hard drive.
Sluggish startup or shutdown	Run ScanDisk and Disk Defragmenter to check and optimize the hard drive. Delete temporary and unneeded files.		Use same suggestions shown at left.
Password has been forgotten	Verify proper ownership, then follow the removal procedure with the owner and log the appropriate data—see page 5-1.		The user must call Technical Support and provide proof of ownership. Password removal is restricted to certain sites. See page 5-1.
Power/Battery			
Short battery operating time	Turn down display brightness. Check power management settings in BIOS Setup. Try the default settings. For an OmniBook 4150B, shut down and restart. During boot at the F2 prompt, press F6. This starts a process that recalibrates the battery gauge, possibly improving operating time. When the discharge cycle ends, you may have to unplug and reconnect the ac adapter to begin recharging. Inform user that certain applications can cause excess power usage. (User can get power monitor from www.intel.com and monitor CPU load.) Some PC cards (PCMCIA) draw power even while not in use. Heavy modem use can affect battery operating time.	Battery. Motherboard.	Battery capacity often decreases after a year or more. For an F1629A OmniBook 4150† with certain serial numbers between TW84257202 and TW84358133, check the CPU module to see if it must be replaced—see Service note 4150-01.
Does not run on battery, empty battery indication	Check battery contacts. If available, try another battery.	Battery or contacts. Motherboard.	

Symptom	Call Center: Suggestions	Repair Center: Likely Causes	Repair Center: Comments
Battery does not charge	Check the power source. Check battery contacts. If available, try another battery and ac adapter. Check for high ambient temperature and blocked air vents.	Battery or contacts. AC adapter. Motherboard. Fan. DC-DC PCA.	Check ac adapter. Check fan.
Second battery does not work, main battery works	Try swapping the two batteries. Check contacts on second battery. Second battery does not charge until main battery is fully charged.	Second battery or contacts. Motherboard.	
Battery indicator is inaccurate	Completely charge and discharge the battery 2 to 4 cycles in the unit. For an OmniBook 4150B, shut down and restart. During boot at the F2 prompt, press F6. This starts a process that recalibrates the battery gauge, possibly improving operating time. When the discharge cycle ends, you may have to unplug and reconnect the ac adapter to begin recharging.	Motherboard.	Try cycling the battery charge.
Display			
Dark display, no light	Adjust display brightness. Press Fn+F5 several times. Try external monitor.	LCD module (backlight). LCD cable or connections. Inverter PCA. LVDS PCA.	Reseat the VGA PCA. If an external monitor displays no image, replace the VGA PCA instead, then motherboard.
White display	Adjust display brightness.	LCD module. Inverter PCA. LVDS PCA.	
Erratic display		LCD cable or connections. LCD module.	
Bright or missing pixels or lines	See quality statement on page 5-2.	LCD module. LCD cable or connections.	See quality statement on page 5-2.
For a 13-inch LCD, noise or discoloration when the display is moved		LCD cable connection.	Remove the LCD shield and check the flex cable connection at the back of the 13-inch LCD module. Two rubber spacers should be behind the connector. After the shield is installed, it should be taped to the flex cable. See the caution on page 2-16. (Service notes 4100-04, 4100-05.)

Symptom	Call Center: Suggestions	Repair Center: Likely Causes	Repair Center: Comments
Hard disk			
Hard disk never spins	Check the power source. Remove and reinsert the hard drive. Check the contacts.	Hard drive or contacts. Motherboard. Hard drive case (flex cable).	If the drive case is damaged, it can prevent proper operation.
Hard disk makes clunking or scratching noise	Back up the drive immediately. Was the computer or drive dropped?	Hard drive.	Check the computer and drive for evidence of customer abuse.
Hard disk makes buzzing or whining noise	Back up the drive immediately. Check for alternate noise sources, such as a PCMCIA drive or fan. If a keystroke causes the sound to change, it may be power supply noise.	Depends on the source of the noise.	
Files are corrupted	Run a virus scan program. Check the disk surface by running Scandisk (Windows 95/98) or Disk Administrator (Windows NT). Or boot to DOS and run CHKDSK to look for problems, run CHKDSK /f to fix. Use Recovery CD to restore original factory software.		Use same suggestions shown at left.
Drive capacity is less than normal	Check the disk surface by running Scandisk (Windows 95/98) or Disk Administrator (Windows NT). Check partitions using FDISK (Windows 95/98) or Disk Administrator (Windows NT).	Hard drive.	Use same suggestions shown at left. Recreate the Hibernate partition, then partition and format the disk.
Floppy drive			
General problems	Check floppy module contacts. Try using alternate connection (with or without floppy cable). Check settings in BIOS Setup.	Floppy module or contacts. Floppy cable. Motherboard.	
Keyboard			
Some or all keys do not work properly		Keyboard. Motherboard. BIOS IC.	Try reinserting the flex cable in the connector on the VGA PCA.
PS/2 keyboard and mouse with Y-adapter do not work	Check devices separately.	Y-adapter. PS/2 device. Motherboard.	

Symptom	Call Center: Suggestions	Repair Center: Likely Causes	Repair Center: Comments
Pointing stick			
General problems	Check settings in Control Panel. Check that the pointing stick is enabled in BIOS Setup.	Keyboard assembly. Motherboard.	Try reinserting the flex cable in the connector on the VGA PCA.
Special TrackPoint driver features not working	If installed, remove TouchPad driver support using Add/Remove Program. In Mouse Properties, select the IBM TrackPoint driver from the track-point directory under \OmniBook\Drivers.	Keyboard assembly. Motherboard.	
Click button doesn't work		Top case. Motherboard.	
For an OmniBook 4100: Drifting or erratic pointer using pointing stick	For an OmniBook 4100, check whether serial number is between TW82000000 and TW83599999.	Keyboard assembly.	For an OmniBook 4100 with serial number between TW82000000 and TW83599999, check the date code on the bottom of the keyboard. If the date code is "828", replace the keyboard. (Service note 4100-02.)
Touch pad			
General problems	Check settings in Control Panel. Check pointing stick settings in Control Panel. The IBM TrackPoint driver can redefine touch pad operation. Check that the touch pad is enabled in BIOS Setup.	Top case. Motherboard.	
Special TouchPad driver features not working	If installed, remove IBM TrackPoint support using Add/Remove Program, then in Mouse Properties, select the standard PS/2 mouse. Disable the pointing stick in BIOS Setup, enable the touch pad. Run Setup.exe from the touch-pad subdirectory under \OmniBook\Drivers.	Top case. Motherboard.	
Click button doesn't work		Top case. Motherboard.	

Symptom	Call Center: Suggestions	Repair Center: Likely Causes	Repair Center: Comments
Audio			
Sound does not play	<p>Check settings in BIOS Setup.</p> <p>Increase sound volume (Fn+UP and software controls).</p> <p>Check whether mute is active (mute button and software controls).</p> <p>Check for sound resource conflicts in Device Manager (Windows 95/98) or Administrative Tools or Control Panel System (Windows NT).</p>	<p>Speakers.</p> <p>VGA PCA (OB 4150†).</p> <p>Motherboard.</p>	<p>Check operation using headphones or external speakers (audio jack PCA).</p>
Sound does not record	<p>Check settings in BIOS Setup.</p> <p>Check software controls for microphone—it should not be muted in recording panel.</p> <p>Note: The microphone should normally be muted in the master output panel.</p>	<p>Inverter PCA (mic).</p> <p>Motherboard.</p> <p>VGA PCA (OB 4150†).</p>	<p>Check operation using external microphone (audio jack PCA).</p>
Serial/Parallel			
General problems	<p>Check settings in BIOS Setup.</p> <p>Check settings in Control Panel (and in Windows NT Diagnostics).</p>	<p>Motherboard.</p>	<p>Use loop-back connector during test—see page 3-15.</p>
Infrared			
General problems	<p>Infrared communication is not supported in Windows NT 4.0.</p> <p>Infrared is disabled and no drivers installed as shipped. (Drivers are included.)</p> <p>Check settings in BIOS Setup.</p> <p>Standard IrDA and fast-IrDA are incompatible (they use different drivers).</p> <p>For fast-IrDA, check for DMA conflict with ECP parallel port.</p>	<p>IR PCA.</p> <p>Motherboard.</p>	
USB			
General problems	<p>USB is not supported in Windows NT 4.0.</p>	<p>Motherboard.</p>	

Symptom	Call Center: Suggestions	Repair Center: Likely Causes	Repair Center: Comments
PCMCIA			
General problems	<p>Make sure Card Executive is installed for Windows NT. If the card requires an IRQ, check that there is one available.</p> <p>Check for conflicts or refresh the device list in Device Manager (Windows 95) or Administrative Tools or Control Panel System (Windows NT).</p> <p>Reboot the computer.</p> <p>Try the card in the other slot or in another computer.</p> <p>Check the OmniBook website for installation instructions (page vi).</p> <p>Download current drivers from the card manufacturer's website.</p>	Motherboard. PCMCIA socket.	<p>Using a flashlight, look for bent pins inside the PCMCIA socket.</p> <p>If both slots have problems, replace the motherboard. If only one slot has a problem, try replacing the PCMCIA socket.</p>
AC adapter			
Does not power the OmniBook	Try another ac adapter, if available.	AC adapter. DC-DC PCA. Motherboard.	The ac adapter is not repairable—it must be replaced.
Miscellaneous			
Clock loses time	Plug in ac adapter for 24 hours to charge backup battery.	Motherboard.	Charge backup battery.
Computer gets hot	<p>It is normal for the computer to get hot.</p> <p>Make sure the air vents are clear.</p> <p>DOS games and other programs that drive CPU usage toward 100% can contribute.</p>	Fan. Thermal connections. Heatsink damage.	<p>Check the fan.</p> <p>Check for proper contact between CPU and its top plate, and between heatpipe and heatsink.</p>

Symptom	Call Center: Suggestions	Repair Center: Likely Causes	Repair Center: Comments
Computer pauses or runs sluggishly	<p>May be normal Windows behavior (background processing can affect response time).</p> <p>If the hard disk has spun down to conserve power, it can take several seconds to spin up. You can hear this. You can run BIOS Setup and change the hard disk time-out to match the Suspend time-out.</p> <p>Certain background operations (such as HP COE virus scans) can affect performance while they're running.</p> <p>Some file browsers may be unresponsive while they're processing a graphic image or waiting for broken network connections to time out.</p> <p>Check for overheating—see the previous symptom.</p> <p>Run BIOS Setup and try turning off smart CPU mode.</p>	<p>CPU module.</p> <p>Motherboard.</p>	<p>If computer slows after a period of continuous activity, check thermal connections and parts—see the previous symptom.</p>
Accessories			
Docking product I/O problems	<p>Check that ac power is connected.</p> <p>Check settings in BIOS Setup.</p> <p>Try using the corresponding OmniBook port.</p>	<p>Docking product.</p> <p>Motherboard.</p>	<p>Test the corresponding OmniBook ports while undocked.</p> <p>The port replicator and mini dock are not repairable—they must be exchanged.</p> <p>The docking system is repairable—see its service manual.</p> <p>For an F1629A OmniBook 4150† with certain serial numbers between TW84257202 and TW84358133, check the CPU module to see if it must be replaced—see Service note 4150-01.</p>
Can not boot from CD in CD-ROM drive	<p>Check that the CD is bootable.</p> <p>During boot, do not press ESC before the F2 prompt—or check boot order in BIOS Setup.</p>	<p>CD-ROM drive.</p>	<p>The CD-ROM drive is not repairable—it must be exchanged.</p>
General plug-in module problems	<p>Check module contacts.</p> <p>Push system-off button.</p>	<p>Plug-in module or contacts.</p> <p>Motherboard.</p>	<p>Plug-in modules are not repairable—they must be exchanged.</p>
<p>† Models called 4150† in this manual have no marking in the serial number, whereas models called 4150B have 4150 B after the serial number.</p>			

Diagnostic Tools

This section describes the following diagnostic tools you can use for troubleshooting and repairing the OmniBook:

- OmniBook hardware diagnostic program (below).
- Power-on self-test (page 3-20).
- Sycard PCCtest 450 PC Card (page 3-23).
- Desktop Management Interface (page 3-23).
- BIOS Setup utility (page 3-26).

OmniBook Diagnostic Program

The OmniBook hardware diagnostic program provides two levels of testing:

- User-level testing using the basic hardware test.
- Advanced testing using the individual hardware tests.

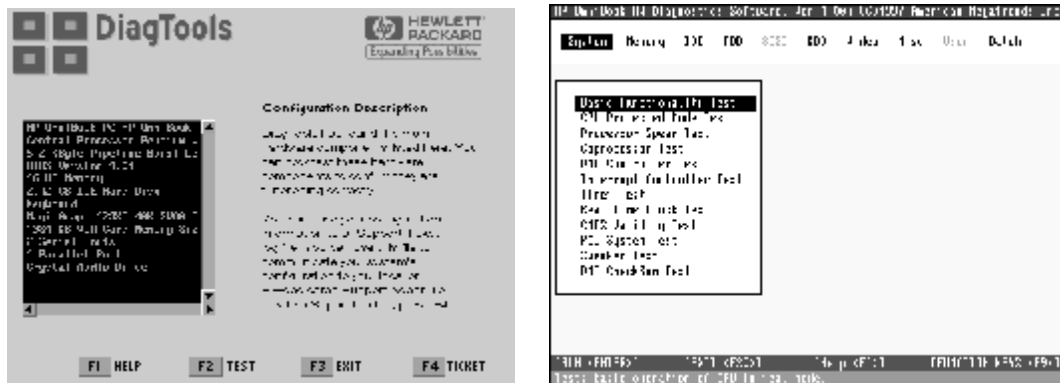

Figure 3-2. OmniBook Diagnostic Screens — Basic and Advanced

The tests are designed to run after the system reboots. This ensures that the computer will be in a predictable state, so the diagnostic program can properly test the hardware components. The tests are non-destructive and are intended to preserve the state of the computer. The OmniBook reboots when you exit the program so drivers can be loaded.

Creating a Diagnostic Floppy Disk

Note

For units with BIOS 2.12 or later, you can run the diagnostic program from the hard disk — without creating a diagnostic floppy disk. If, during boot, the computer displays "F10 to start diagnostic," press F10 to run the diagnostic test from the hard disk.

If you need a diagnostic floppy disk, insert a formatted floppy disk in the floppy drive and do one of the following:

- Check the \Dmi\Hpdiags directory. If **diaginst** is in this directory, run it.
–or–
If TopTools is installed, check whether the DiagTools page can create the disk.
- On any computer with World Wide Web access, download the diagnostic software package from the OmniBook website (see page vi), then follow the instructions.

Running the Diagnostic Test

1. If you're using a diagnostic floppy disk, insert it in the floppy drive—or press F10 in the next step.
2. Reboot the OmniBook.
3. Go through the first several screens.
4. When the hardware detection finishes, check the list of detected hardware. The following information and devices should be listed if applicable:

Product name	Cache memory	Graphics adapter
Processor type	Main memory	Serial ports
BIOS version	IDE drives	Parallel port
Serial number		Audio device

Note

If a device is not detected or fails its test below, it may be configured incorrectly in the BIOS Setup utility (page 3-26). You can confirm the problem by running BIOS Setup and checking the settings.

5. **Run the basic test.** Press F2 to start the basic hardware test.
6. If you intend to exit without running advanced tests, press F4 to save system and test information in the Support Ticket log file, HPSUPPT.TXT. Then remove the diagnostic disk, if present, and press F3 to exit.
7. **Run the advanced tests.** Press F2 to open the advanced test screen.
8. Select and run the appropriate tests. Tests are not listed if no such hardware is detected. Press the following keys to run tests:

ENTER	Runs the highlighted test.
F5 or SPACE	Marks or unmarks the highlighted test.
F6	Marks or unmarks all tests in the current menu.
F7	Marks or unmarks all tests in all menus.
F10	Runs all marked tests.

If any test fails, the error is logged (error code and description) and displayed temporarily (error code). If several errors occur, look for patterns that might indicate a common cause. See the table on page 3-15 for repair suggestions. Consider these suggestions in combination with other troubleshooting information.
9. When you are finished running tests, press ESC to exit the advanced tests.
10. Press F4 to save system and test information in the Support Ticket log file, HPSUPPT.TXT.
11. **Exit.** Press F3 to exit and reboot.
12. **Optional: Check the log.** The log file contains a hardware summary and a list of all test results and errors. Run C:\Dmi\Hputils\Hpsuppt.exe to retrieve the log file to this directory and open it in Notepad—or, if you are using a diagnostic floppy, the log file Hpsuppt.txt is on the floppy disk.

Note that the serial and parallel port tests are more thorough if you connect a loop-back connector to the port before running the test for that port. See the wiring diagrams below.

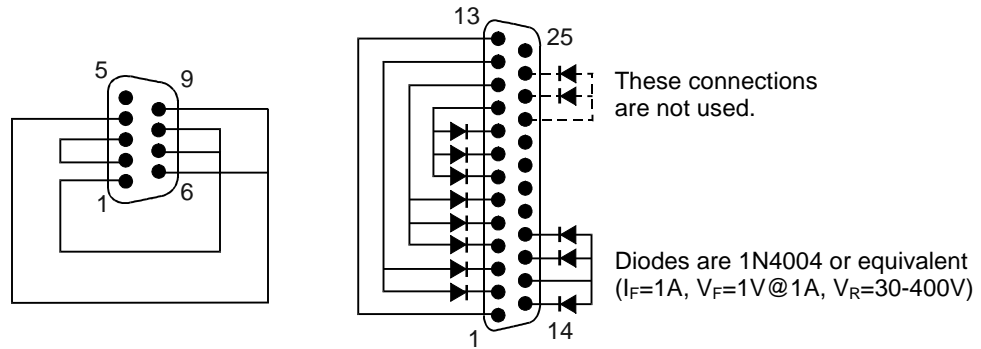

Figure 3-3. Serial and Parallel Loopback Connectors

Interpreting the Results

- The following table lists test groups, error codes, and suggestions for follow-up actions. Consider these suggestions in combination with other troubleshooting information.

Table 3-3. OmniBook Diagnostic Error Codes

Code	Suggestions	Code	Suggestions
Note: For the OmniBook 4150 Series, if you are directed to replace the BIOS IC, either reprogram it (see page 2-30 if it may be corrupted) or replace the motherboard.			
System Tests			
0001h - 0008h	Reseat or replace the CPU module.	0087h	Replace the motherboard.
0009h	Replace the motherboard.	0088h	Replace the BIOS IC.
0010h - 002Fh	Reseat or replace the CPU module.	008Ah	Replace the motherboard.
0030h - 0040h	Replace the motherboard.	0090h - 0096h	Replace the BIOS IC. Replace the motherboard.
0041h	Unrecognized interrupts. Run BIOS Setup and check IRQ assignments for all devices.	009Ah - 009Eh	Replace the BIOS IC. Replace the motherboard.
0050h - 0070h	Replace the motherboard.	009Fh	Insufficient DOS memory. Load fewer device drivers.
0071h	Bad CMOS checksum. Reset the system, then run BIOS Setup and check settings. Replace motherboard.	00A0h	No repair. (ESCD not supported.)
0072h	Configuration mismatch in CMOS. Reset the system, then run BIOS Setup and check settings. Replace motherboard.	00A1h	Replace the BIOS IC. Replace the motherboard.
0073h	Bad CMOS RAM size. Reset the system, then run BIOS Setup and check settings. Replace motherboard.	00A2h - 00A3h	No repair. (ESCD not supported.)
0074h	Bad CMOS time. Reset the system, then run BIOS Setup and check settings. Replace motherboard.	00A4h	Replace the BIOS IC.
0075h - 0076h	Reset the system. Replace the motherboard.	00A5h - 00A6h	No repair. (ESCD not supported.)
0077h	Replace the motherboard.	00A7h	Replace the BIOS IC. Replace the motherboard.
0078h	Bad CMOS checksum. Reset the system, then run BIOS Setup and check settings. Replace motherboard.	00C0h - 00CCh	Replace the CPU module.
0079h	Replace the motherboard.	00FFh	Rerun the test. (Possible diagnostic programming error.)
0083h - 0086h	Replace the BIOS IC. Replace the motherboard.	Memory Tests	
		The addresses below are absolute (32-bit) address. These addresses are not in the segment:offset format.	
		0100h - 0101h	Replace the motherboard.
		0102h	Reprogram the BIOS IC. Replace the BIOS IC, replace the motherboard.
		0120h - 0131h	For the OB 4100 for 01FFFFFFh and below, replace the motherboard. Otherwise, replace the RAM board (each 01000000h represents 16MB). Replace the motherboard.

Code	Suggestions
0132h - 0150h	For the OB 4100 for 01FFFFFFh and below, replace the motherboard. Otherwise, replace the RAM board (each 01000000h represents 16MB).
0160h	Address bus short. Remove any RAM board and rerun the test. Check the CPU module for shorts. Replace the motherboard.
0170h - 0172h	Replace the motherboard.
0180h	For the OB 4100 for 01FFFFFFh and below, replace the motherboard. Otherwise, replace the RAM board (each 01000000h represents 16MB).
0181h	Replace the CPU module.
0182h	Unload HIMEM.SYS or make sure that another application is not using all extended memory allocated by HIMEM.SYS.
0183h	No extended memory. Check installation of the RAM board. Replace the motherboard.
0184h	Remove or swap RAM boards. (OmniBook 4150 must have one RAM board present.) Replace the CPU module, replace the motherboard.
0190h - 01A0h	For the OB 4100 for 01FFFFFFh and below, replace the motherboard. Otherwise, replace the RAM board (each 01000000h represents 16MB).
01A1h - 01A4h	Replace the CPU module.
01B0h	For the OB 4100 for 01FFFFFFh and below, replace the motherboard. Otherwise, replace the RAM board (each 01000000h represents 16MB). Replace the motherboard.
01B1h - 01B3h	For the OB 4100 for 01FFFFFFh and below, replace the motherboard. Otherwise, replace the RAM board (each 01000000h represents 16MB).
Hard Disk Tests	
0201h	Replace the hard disk. Replace the motherboard.
0202h - 0204h	Rerun the test. If error persists, replace the hard disk.
0205h	Replace the motherboard.
0207h	Run BIOS Setup and check the hard disk type. Check internal and external hard disk connectors and motherboard connector. Replace the hard disk.
0208h - 0209h	Transient DMA error. Rerun the test.
020Ah - 0211h	Rerun the test. Run SCANDISK or equivalent.
0220h	Replace the motherboard.
0240h	Replace the hard disk. Replace the motherboard.
0252h - 0254h	Rerun the test. Run SCANDISK or equivalent.
025Ah - 0260h	Rerun the test. If error persists, replace the hard disk.

Code	Suggestions
0265h	Check internal and external hard disk connectors and motherboard connector. Replace the hard disk. Replace the motherboard.
0275h	Replace the hard disk.
0280h	Check internal and external hard disk connectors and motherboard connector. Replace the hard disk.
0281h	Replace the hard disk.
0290h	Rerun the test. If the error persists, replace the hard disk.
0293h - 0296h	Replace the hard disk.
02AAh	Check internal and external hard disk connectors and motherboard connector. Replace the hard disk.
02CCh	Run BIOS Setup and check the hard disk type. Replace the hard disk or the motherboard.
02EEh	For the performance test, run BIOS Setup and temporarily select a drive type that has more than 200 cylinders.
02F1h	Recreate the Hibernate partition, then run FDISK to partition the hard disk.
02F2h	Run FDISK to make one partition active. If necessary, recreate the Hibernate partition, then run FDISK to partition the hard disk.
02F3h - 02F5h	Reformat the hard disk. If necessary, recreate the Hibernate partition, then run FDISK to partition the hard disk.
02F6h	Recreate the Hibernate partition, then run FDISK to partition the hard disk.
02FFh	Check internal and external hard disk connectors and motherboard connector. Replace the hard disk. Replace the motherboard.
9602h - 9607h	(See Hard Disk Tests at end of table.)
Floppy Disk Tests	
0301h	Replace the floppy drive. Replace the motherboard.
0302h	Run BIOS Setup and check the floppy drive type. Replace the floppy drive.
0303h	Insert a floppy disk without write protection.
0304h	Run BIOS Setup and check the floppy drive type. Replace the floppy drive.
0305h	Replace the motherboard.
0307h	Run BIOS Setup and check the floppy drive type. Check the connectors on the floppy drive and motherboard. Replace the floppy drive.
0308h - 0309h	Transient DMA error. Rerun the test.
030Ah - 0310h	Rerun the test with a good floppy disk. Replace the floppy drive.
0311h	Rerun the test with another floppy disk.
0321h - 0322h	Replace the floppy drive.
0340h	Replace the motherboard.
0341h	Replace the floppy drive. Replace the motherboard.

Code	Suggestions
0342h - 0344h	Run BIOS Setup and check the floppy drive type. Replace the floppy drive.
0345h	Replace the motherboard.
0347h	Run BIOS Setup and check the floppy drive type. Check the connectors on the floppy drive and motherboard. Replace the floppy drive.
0348h - 0349h	Transient DMA error. Rerun the test.
0350h	Rerun the test with another floppy disk. Replace the floppy drive.
0360h	Replace the motherboard.
0380h - 03AAh	Make sure the floppy disk is fully inserted. Check the connectors on the floppy drive and motherboard. Replace the floppy drive.
03CCh	Run BIOS Setup and check the floppy drive type. Rerun the test with another floppy disk. Replace the floppy drive. Replace the motherboard.
03EEh - 03FFh	Check the connectors on the floppy drive and motherboard. Rerun the test with another floppy disk. Replace the floppy drive. Replace the motherboard.
Keyboard Tests	
0400h - 0401h	Replace the motherboard.
0410h - 0414h	Check the keyboard flex cable connection. Replace the keyboard. Replace the motherboard.
0415h	Replace the VGA PCA for OB 4100 only. Replace the motherboard.
0416h - 0418h	Replace the keyboard. Replace the motherboard.
SCSI Tests	
0500h	Reinitialize the SCSI device.
0502h	Make sure all SCSI devices are turned on and ready. Make sure the SCSI termination and all SCSI connectors are properly installed. Rerun the test. Reformat the SCSI drive. Replace the SCSI drive.
0503h - 0504h	Reformat the SCSI drive. Replace the SCSI drive.
0505h - 0507h	Replace the SCSI drive
0508h - 050Ah	Reformat the SCSI drive. Replace the SCSI drive.
050Bh	Check the connectors on the SCSI drive. Replace the SCSI drive.
050Ch - 050Eh	Reformat the SCSI drive.
0510h	Insert a tape cartridge in the drive.
0511h	Replace the tape cartridge.
0512h	Run the Write test again.
0514h - 0516h	Replace the tape cartridge. Replace the tape drive.
0520h	Insert a CD in the SCSI CD-ROM drive.
0521h	Insert a computer CD in the SCSI CD-ROM drive.
0523h	Insert an audio CD in the SCSI CD-ROM drive.
0524h	Insert a CD in the SCSI CD-ROM drive.

Code	Suggestions
0525h	Transient error. Rerun the test.
0526h	Replace the CD-ROM drive, but only if it has an automatic close feature.
0527h	Replace the CD-ROM drive.
0528h	Replace the medium. Replace the SCSI device.
0550h	Replace the SCSI device.
0560h	Rerun the test. (Possible diagnostic programming error.)
0580h	Insufficient DOS memory. Load fewer device drivers.
0590h	If test does not fail on identical known good device, replace the SCSI device.
Serial Port Tests	
0601h	For the external loop-back test, make sure the loop-back connector is installed and constructed properly. For the external or internal loop-back test, replace the motherboard.
0602h	Replace the motherboard.
0603h	For the external loop-back test, make sure the loop-back connector is installed and constructed properly. For the external or internal loop-back test, replace the motherboard.
0604h - 0605h	Replace the motherboard.
0606h	For the external loop-back test, make sure the loop-back connector is installed and constructed properly. For the external or internal loop-back test, replace the motherboard.
0607h	Make sure the loop-back connector is installed and constructed properly. Replace the motherboard.
0608h - 0617h	Replace the motherboard.
Parallel Port Tests	
0701h	For the external loop-back test, make sure the loop-back connector is installed and constructed properly. For the external or internal loop-back test, replace the motherboard.
0702h	For DiagTools 2.2, replace motherboard. For earlier version, no repair (printer test not supported).
0703h	Run BIOS Setup and disable ECP for the parallel port, then rerun the test. Replace the motherboard.
0704h - 0706h	Replace the motherboard.
0707h	Connect the loop-back connector.
0708h	Replace the motherboard.
Audio Tests	
0801h - 08C2h	If this error also occurs for an external headphone, replace the motherboard (or VGA PCA for the OB 4150†). Otherwise, check the speaker connections, replace the speakers. If it occurs only for an external headphone, replace the audio jack PCA.

Code	Suggestions
08D0h - 08F3h	Replace the motherboard (or VGA PCA for the OB 4150†).
9003h - 9004h	(See Microphone Tests near end of table.)
9018h - 901Ah	(See NMA2 Sound near end of table.)
Video Tests	
0900h - 0901h	Replace the VGA PCA.
0903h - 0906h	Replace the LVDS PCA. Replace the VGA PCA.
0907h - 0908h	Replace the VGA PCA.
0909h - 090Ah	Replace the LVDS PCA. Replace the VGA PCA.
090Ch - 090Fh	Replace the VGA PCA.
0911h	If this test fails on the internal display, replace the VGA PCA.
0912h - 0915h	Replace the VGA PCA.
0920h	Replace the LVDS PCA. Replace the VGA PCA.
8000h, 9016h - 9017h	(See Video Tests near end of table.)
CD-ROM Tests	
0A00h	Insert a CD in the drive.
0A01h	Rerun the test. Replace the CD-ROM drive.
0A02h	No repair. (Automatic close not supported.)
0A03h	Insert a different CD in the drive. Check the connectors on the CD-ROM drive and motherboard. Replace the CD-ROM drive.
0A04h	Insert a computer CD in the drive.
0A05h	Insert a different CD in the drive. Check the connectors on the CD-ROM drive and motherboard. Replace the CD-ROM drive.
0A06h	Insert a computer CD in the drive. Replace the drive. For earlier diagnostics, insert an audio CD in the drive.
0A07h	Rerun the test. Replace the drive.
0A08h	Insert an audio CD. Replace the drive.
0A09h	Rerun the test. Replace the drive.
0A10h	Insert an audio CD. Replace the drive.
0A11h	Rerun the test with an audio CD. Replace the drive.
0A12h	Insert a different multisession CD. Replace the drive.
SMBus Tests	
0E00h - 0E10h	Replace the motherboard.
ATAPI Removable Tests (LS-120)	
0F01h	Connect the LS-120 drive and rerun the test.
0F02h - 0F03h	Rerun the test. Insert a different disk in the LS-120 drive. Check the connectors on the LS-120 drive and motherboard. Replace the LS-120 drive.

Code	Suggestions
0F04h - 0F05h	Replace the LS-120 drive.
0F06h	Rerun the test. Insert a different disk in the LS-120 drive. Check the connectors on the LS-120 drive and motherboard. Replace the LS-120 drive.
0F07h	Replace the LS-120 drive.
0F08h	Rerun the test. Insert a different disk in the LS-120 drive. Check the connectors on the LS-120 drive and motherboard. Replace the LS-120 drive.
0F09h	Replace the LS-120 drive.
TI CardBus Tests	
1201h	Memory space not available. Remove any attached ISA or PCI cards.
1202h - 1203h	Replace the motherboard.
1205h - 1206h	Insert a different PC Card. Replace the PCMCIA socket. Replace the motherboard.
1207h	Reboot the computer. Replace the motherboard.
USB Tests	
1301h	Reprogram the BIOS IC. Replace the BIOS IC. Replace the motherboard.
1302h - 1316h	Replace the motherboard.
9006h	(See USB Port Test near end of table.)
ACPI Tests	
1701h - 1702h	Reprogram the BIOS IC. Replace the BIOS IC, replace the motherboard.
DVD Tests	
1900h - 1902h	Insert a different DVD in the drive. Replace the DVD drive.
Fan Tests	
9001h	If the fan is already running, you will not hear a change. Check the fan connection. Replace the fan. Replace the motherboard.
9002h	Reboot the computer. Replace the motherboard.
Microphone/Line-In Tests	
9003h	If the error occurs for built-in and external microphones, replace the motherboard (or VGA PCA for the OB 4150†). If it occurs for only the built-in microphone, check the LCD flex cable connection, replace the inverter PCA. If it occurs only for an external microphone, replace the audio jack PCA.
9004h	Verify a good signal on the input line. Replace the audio jack PCA. Replace the motherboard (or VGA PCA for the OB 4150†).
Suspend/Resume Test	
9005h	Run BIOS Setup and restore default settings. Reprogram the BIOS IC. Replace the BIOS IC. Replace the motherboard.
USB Port Test	
9006h	Make sure a USB device is connected to the port you are testing. Select the correct speed for the device. Replace the motherboard (or dock component, if applicable).

Code	Suggestions
IR Tests (FIR enabled, undocked)	
9002h	Reboot the computer. Replace the motherboard.
9007h - 9008h	Reboot the computer. Run BIOS Setup and restore default settings. Replace the motherboard.
9009h	Do not run this test in Windows. For the one-unit test, replace the motherboard. For the two-unit test, make sure the IR ports on the reflector and test computers are lined up, replace the IR PCA, replace the motherboard.
900Ah	Rerun the test. For the two-unit test, make sure the IR ports on the reflector and test computers are lined up. Replace the IR PCA, replace the motherboard.
900Ch	Rerun the test. Make sure the IR ports on the reflector and test computers are lined up. Restart the reflector unit. Replace the IR PCA, replace the motherboard.
Video Tests	
8000h	If the test fails with an external monitor (must support VESA mode 105h), replace the VGA PCA, replace the motherboard. Otherwise: - If the shaded-band test fails, check the LCD flex cable connection in the bottom case, replace the LVDS PCA, replace the LCD flex cable, replace the VGA PCA, replace the motherboard. - If only a solid-color test fails, see chapter 5 for cosmetic guidelines, replace the LCD module.
9016h	Reboot the computer. Reprogram the BIOS. Replace the VGA PCA.
9017h	See chapter 5 for cosmetic guidelines, replace the LCD module.

Code	Suggestions
NMA2 Sound Tests	
9018h - 901Ah	If this error also occurs for an external headphone, replace the VGA PCA. Otherwise, check the speaker connections, replace the speakers. If it occurs only for an external headphone, replace the audio jack PCA.
Dock Tests	
9071h, 9073h	Update BIOS in computer. Replace electronics PCA in dock.
9075h, 9077h - 9078h	Replace electronics PCA in dock.
907Bh	Replace LED/button assembly in dock.
9082h	Rerun test with known good computer. Replace electronics PCA in dock.
9088h	Replace electronics PCA in dock.
Hard Disk Tests	
9602h	Failure may occur soon. Back up data and replace the hard disk.
9603h	Rerun the hard disk test.
9604h	Reformat the hard disk. If necessary, recreate the Hibernate partition, then run FDISK to partition the hard disk.
9605h	For a computer that does not give an F10 prompt at boot (old Hibernate partition) or that has a non-Windows operating system, this error may not indicate a failure. Otherwise, reformat the hard disk. If necessary, recreate the Hibernate partition, then run FDISK to partition the hard disk.
9606h	Reformat the hard disk. If necessary, recreate the Hibernate partition, then run FDISK to partition the hard disk.
9607h	Back up data, then reformat the hard disk. Replace the hard disk.

Power-On Self-Test

Note

If Quiet Boot is enabled in BIOS Setup (the default setting), press ESC during boot to see POST messages.

The POST (Power-On Self-Test) is a series of initialization routines and diagnostic tests that the system BIOS runs when the computer boots. The system BIOS will not boot the operating system if system memory, the CPU, DMA, or the interrupt controller fails the POST diagnostic tests. POST progress is indicated by a sequence of codes. If possible, error messages are displayed.

You should not interpret the failure of one or more POST tests as a hardware, software, or firmware failure. First, confirm the failure with a “clean” boot:

- Remove all accessories, including RAM boards, floppy drive, port replicator, PC Cards, printer, external monitor, pointing device, and keyboard.
- Provide “clean” ac power—no auto adapter or unusual ac adapter configuration.
- Press the system-off button to start from a known state.

If the computer fails to boot with a clean boot, it requires repair. If an error message is displayed, *confirm the problem using other diagnostic tools*. Not all POST messages indicate a hardware, software, or firmware failure—some messages are informational messages.

If the BIOS detects a terminal error condition, it halts POST after issuing a terminal error beep code—up to four groups of 1 to 4 short beeps. The beep code indicates the POST routine in which the terminal error occurred. The BIOS also issues a beep code (one long tone followed by two short tones) during POST if the video configuration fails (no card installed or faulty) or if an external ROM module does not properly checksum to zero.

Table 3-4. POST Terminal-Error Beep Codes

Beep Codes	POST Description
1	One short beep before boot
1-2	Search for option ROMs. One long, two short beeps on improper video configuration (check VGA switches on OmniBook 4150B) or external ROM checksum failure
1-2-2-3	BIOS ROM checksum
1-3-1-1	Test DRAM refresh
1-3-1-3	Test 8742 Keyboard Controller
1-3-4-1	RAM failure on address line xxxx
1-3-4-3	RAM failure on data bits xxxx of low byte of memory bus
1-4-1-1	RAM failure on data bits xxxx of high byte of memory bus
2-1-2-3	Check ROM copyright notice
2-2-3-1	Test for unexpected interrupts

The following table lists POST messages and explanations for reported problems. If the system fails after you make changes in BIOS Setup, reset the computer, enter BIOS Setup, and install the defaults or correct the error.

Table 3-5. POST Messages

Message	Description
0200 Failure Fixed Disk	Fixed disk is not working or not configured properly. Check to see if fixed disk is attached properly. Run Setup. Find out if the fixed-disk type is correctly identified.
0210 Stuck key	Stuck key on keyboard.
0211 Keyboard error	Keyboard not working.
0212 Keyboard Controller Failed	Keyboard controller failed test. May require replacing keyboard controller.
0213 Keyboard locked - Unlock key switch	Unlock the system to proceed.
0220 Monitor type does not match CMOS - Run SETUP	Monitor type not correctly identified in Setup
0230 Shadow Ram Failed at offset: <i>nnnn</i>	Shadow RAM failed at offset <i>nnnn</i> of the 64k block at which the error was detected.
0231 System RAM Failed at offset: <i>nnnn</i>	System RAM failed at offset <i>nnnn</i> of in the 64k block at which the error was detected.
0232 Extended RAM Failed at offset: <i>nnnn</i>	Extended memory not working or not configured properly at offset <i>nnnn</i> . Update to the latest BIOS version 2.xx. (Service note 4100-06.)
0250 System battery is dead - Replace and run SETUP	The CMOS clock battery indicator shows the battery is dead. Connect the ac adapter for at least 24 hours, replace the motherboard.
0251 System CMOS checksum bad - Default configuration used	System CMOS has been corrupted or modified incorrectly, perhaps by an application program that changes data stored in CMOS. The BIOS installed Default Setup Values. If you do not want these values, enter Setup and enter your own values. If the error persists, check the system battery. Connect the ac adapter for at least 24 hours, replace the motherboard.
0260 System timer error	The timer test failed. Requires repair of system board.
0270 Real time clock error	Real-time clock fails BIOS test. May require board repair.
0280 Previous boot incomplete - Default configuration used	Previous POST did not complete successfully. POST loads default values and offers to run Setup. If the failure was caused by incorrect values and they are not corrected, the next boot will likely fail. This error is cleared the next time the system is booted.
0281 Memory Size found by POST differed from CMOS	Memory size found by POST differed from CMOS.
02B0 Diskette drive A error 02B1 Diskette drive B error	Drive A: or B: is present but fails the BIOS POST diskette tests. Check to see that the drive is defined with the proper diskette type in Setup and that the diskette drive is attached correctly.
02B2 Incorrect Drive A type - run SETUP	Type of floppy drive A: not correctly identified in Setup.
02B3 Incorrect Drive B type - run SETUP	Type of floppy drive B: not correctly identified in Setup.
02D0 System cache error - Cache disabled	RAM cache failed and BIOS disabled the cache. On older boards, check the cache jumpers. You may have to replace the cache. See your dealer. A disabled cache slows system performance considerably.
02F0: CPU ID:	CPU socket number for Multi-Processor error.
02F4: EISA CMOS not writeable	ServerBIOS2 test error: Cannot write to EISA CMOS.
02F5: DMA Test Failed	ServerBIOS2 test error: Cannot write to extended DMA (Direct Memory Access) registers.
02F6: Software NMI Failed	ServerBIOS2 test error: Cannot generate software NMI (Non-Maskable Interrupt).

Message	Description
02F7: Fail-Safe Timer NMI Failed	ServerBIOS2 test error: Fail-Safe Timer takes too long.
device Address Conflict	Address conflict for specified device.
Allocation Error for: device	Run ISA or EISA Configuration Utility to resolve resource conflict for the specified device.
CD ROM Drive	CD ROM Drive identified.
Entering SETUP ...	Starting Setup program
Failing Bits: nnnn	The hex number nnnn is a map of the bits at the RAM address which failed the memory test. Each 1 (one) in the map indicates a failed bit. See errors 230, 231, or 232 above for offset address of the failure in System, Extended, or Shadow memory.
Fixed Disk n	Fixed disk n (0-3) identified.
Invalid System Configuration Data	Problem with NVRAM (CMOS) data.
I/O device IRQ conflict	I/O device IRQ conflict error.
PS/2 Mouse Boot Summary Screen:	PS/2 Mouse installed.
nnnn kB Extended RAM Passed	Where nnnn is the amount of RAM in kilobytes successfully tested.
nnnn Cache SRAM Passed	Where nnnn is the amount of system cache in kilobytes successfully tested.
nnnn kB Shadow RAM Passed	Where nnnn is the amount of shadow RAM in kilobytes successfully tested.
nnnn kB System RAM Passed	Where nnnn is the amount of system RAM in kilobytes successfully tested.
Operating system not found	Operating system cannot be located on either drive A: or drive C:. Enter Setup and see if fixed disk and drive A: are properly identified.
Parity Check 1 nnnn	Parity error found in the system bus. BIOS attempts to locate the address and display it on the screen. If it cannot locate the address, it displays ????. Parity is a method for checking errors in binary data. A parity error indicates that some data has been corrupted.
Parity Check 2 nnnn	Parity error found in the I/O bus. BIOS attempts to locate the address and display it on the screen. If it cannot locate the address, it displays ????.
Press <F1> to resume, <F2> to Setup, <F3> for previous	Displayed after any recoverable error message. Press <F1> to start the boot process or <F2> to enter Setup and change the settings. Press <F3> to display the previous screen (usually an initialization error of an Option ROM, such as an add-on card). Write down and follow the information shown on the screen.
Press <F2> to enter Setup	Optional message displayed during POST.
PS/2 Mouse:	PS/2 mouse identified.
System BIOS shadowed	System BIOS copied to shadow RAM.
UMB upper limit segment address: nnnn	Displays the address nnnn of the upper limit of Upper Memory Blocks, indicating released segments of the BIOS which can be reclaimed by a virtual memory manager.
Video BIOS shadowed	Video BIOS copied to shadow RAM.

Sycard PCCTest 450 CardBus Card (Optional)

The PCCTest 450 CardBus Card (version 1.05) available from Sycard Technology is an optional diagnostic tool. It is the only recommended tool that tests the functionality of the PCMCIA slots using a PCMCIA card. It is a Type II CardBus Card that works with compatible test software to exercise PCMCIA functions. (See the Sycard Technology website, <http://www.sycard.com>.) The PCCTest 450 product contains these components:

- PCCTest 450 CardBus Card, version 1.05.
- PCCTest 450 software disk. (Software updates are available at the Sycard Technology website, <http://www.sycard.com>.)
- Configuration headers (PC Card/16-bit and CardBus/32-bit), which attach to the card.

You will also need:

- CardBus extender card to avoid wear on the Sycard PCMCIA connector. The Sycard PCCextend 70 extender card is an example.

The Sycard PCCTest 450 provides the following tests. See the Sycard documentation for details about running the tests.

Table 3-6. Sycard PCCTest Commands

	Slot	PCMCIA PC Card (16-bit) test (PC Card configuration header)	CardBus (32-bit) test (CardBus configuration header)
OmniBook 4150B (PCI1225)	Upper	PCT450 -b69 -1 -v	TESTCB -b69 -1 -v -jsd000
	Lower	PCT450 -b69 -0 -v	TESTCB -b69 -0 -v -jsd000 -k6
OmniBook 4150† (PCI1220A)	Upper	PCT450 -b66 -1 -v	TESTCB -b63 -1 -v -jsd000
	Lower	PCT450 -b66 -0 -v	TESTCB -b63 -0 -v -jsd000 -k6
OmniBook 4100 (PCI1250A)	Upper	PCT450 -b65 -1 -v	TESTCB -b65 -1 -v -jsd000
	Lower	PCT450 -b65 -0 -v	TESTCB -b65 -0 -v -jsd000
† Models called 4150† in this manual have no marking in the serial number, whereas models called 4150B have 4150 B after the serial number.			

Desktop Management Interface (DMI)

The Desktop Management Interface (DMI) is basically a set of rules for accessing information about a personal computer. Using DMI, an application program can determine, for example, which hardware and software components are present in a personal computer, the operating system that is being used, and the number of accessory board slots that are available. Using the DMI interface, a local or remote application program can check what hardware and software components are installed on your computer, and may be able to tell how well they are working or whether any needs replacing. All this information is stored in a special Management Information Format (MIF) file, installed on each personal computer as part of the DMI package.

Installing the DMI Package

The DMI package is included with the OmniBook, but it must be properly installed before it can be used. The following steps explain how.

To install the DMI preloaded on the hard disk:

1. Start Windows, if it is not already running.
2. Click Start, Programs, HP TopTools for Notebooks (or HP DMI), Setup.

To install the DMI from the OmniBook Recovery CD or from floppy disks:

1. If you do not have a CD-ROM drive, create installation floppy disks
 - On any computer with a CD-ROM drive, copy the DMI software from the dmi directory of the Recovery CD (under \omnibook\drivers) to two or more floppy disks (for example, copy the contents of the \disk1 subdirectory to disk #1).
 - On any computer with World Wide Web access, download the TopTools package from the OmniBook website (see page vi), then create the floppy disks as directed.
2. Start Windows, if it is not already running.
3. Insert the Recovery CD into the CD-ROM drive, or insert disk #1 into the floppy drive.
4. Select and run the SETUP program from the dmi\disk1 directory on the CD (under \omnibook\drivers), or from floppy disk #1.

Uninstalling the DMI Package

1. Click Start, Programs, HP TopTools for Notebooks (or HP DMI), Uninstall DMI.
2. Reboot the PC.

Using the DMI Interface

For a complete explanation of how to fully take advantage of DMI, the following documentation is provided with the OmniBook:

- A README.TXT file.
- A Windows online help file describing Hewlett-Packard's implementation of DMI (group and attribute definitions). Since not all Hewlett-Packard enhanced features are supported on all models, this document also describes any restrictions that apply.

Description of DMI

The Desktop Management Interface (DMI) is the result of the efforts of the Desktop Management Task Force (DMTF). This task force was founded in 1992 by a group of leading computer manufacturers, including Hewlett-Packard, to define a standard method of managing the physical and logical components of personal computers.

Hewlett-Packard has developed a number of extensions to DMI to allow the enhanced features of HP OmniBook computer to be managed with DMI, including features such as passwords and tattooing (identifying a computer using a unique string of characters).

For full details of the structure of the MIF file, including an explanation of the meaning of the fields of groups and attributes and how to write an application program that accesses this information, you can access the DMTF FTP server <ftp.dmtf.org> or the DMTF web pages at the <http://www.dmtf.org>.

Contents of the DMI Package

The DMI software and associated documentation is supplied either preinstalled on the OmniBook's hard disk drive or on two floppy disks. The contents of the package are the same in both cases.

Since the information accessed by the DMI software is specific to a particular computer, it must be installed on each computer separately. The DMI package included with the OmniBook can be used only with the OmniBook.

The following software is supplied with the DMI package:

- A Microsoft Windows utility, `SETUP.EXE`, to install and initialize the DMI software.
- A Windows utility, HP TopTools. After DMI is installed, this utility can be used to display information about the computer through the DMI.
- A Management Information Format (MIF) file. This file contains information about everything on the computer that can be controlled using DMI facilities, and is initialized during installation.
- A component code, identifying the version of MIF file to use for specific models of HP OmniBook computers.
- Windows-compatible DMTF Service Layer software, which controls access to the DMI.
- A client agent. The HP Remote DMI Agent is a DMI application and also a network server-side stream-based application. The Remote Agent is listening for Remote Application connection requests. If the main window of the Remote Agent is hidden, then no icon will appear on the screen when it is running.

BIOS Setup Utility

The BIOS Setup utility provides access to basic configuration settings. It is independent of the operating system.

Running the BIOS Setup Utility

1. Close all applications, then shut down Windows and reboot the OmniBook. If necessary, you can press CTRL+ALT+DEL to reboot.
2. During reboot, press F2 to start the BIOS Setup utility.
3. The pointing device or mouse is not active in the BIOS Setup utility. Press the RIGHT and LEFT arrow keys to move among menus. Press the DOWN and UP arrow keys to move among parameters in a menu. Press ENTER to change a setting. See the table below for more information.
4. After you select the options you want, press F10 or use the Exit menu to exit the BIOS Setup utility.

If the settings cause a conflict between devices during reboot, the system prompts you to run BIOS Setup, and the conflicting settings are marked.

Table 3-7. BIOS Setup Menus and Parameters

OmniBook 4150B: Introduced with BIOS version 3.00 (Fall '99).		
OmniBook 4150†: Introduced with BIOS version 2.00 (Fall '98).		
OmniBook 4100: Introduced with BIOS version 1.01 (Spring '98), rolled to version 2.00 (Fall '98).		
Main Menu		Default
Language	Sets the language for this utility and BIOS messages.	English.
BIOS Revision	Shows the current BIOS version.	Detected automatically.
System Time	Sets the time using 24-hour format. Values set take effect immediately.	
System Date	Sets the date using mm/dd/yy (English) or dd/mm/yy format.	
Floppy Drive	Sets the floppy drive type.	Detected and set automatically.
Internal Hard Disk	Sets the hard disk drive type and various parameters.	Detected and set automatically.
Quiet Boot	When enabled, hides summary of power-on self-test and messages during boot.	Enabled
Video Display Device	Sets whether the built-in and external display signals automatically switch when an external display is detected, or whether both signals are active. Pressing Fn+F5 temporarily switches displays.	Auto
BIOS Version 2.xx/3.xx: Video Expansion	Sets whether the video image expands to fill the display in lower resolution modes (SVGA or VGA).	Disabled
BIOS Version 2.xx/3.xx: Primary Video Adapter	Sets whether the internal (built-in) video adapter automatically switches to an external video adapter connected to the docking system, if one is detected. (Select Internal to use multiple-monitor capability of Windows 98.)	Auto
System Memory	Shows the system memory size.	640KB
Extended Memory	Shows the extended memory size.	Detected automatically.
BIOS Version 3.xx: CPU Serial Number	For a processor with a serial number, makes the processor serial number available to software.	Disabled

System Devices Menu		Default
BIOS Version 2.xx/3.xx: PS/2 Pointing Devices	Sets whether internal pointing devices are automatically disabled when an external PS/2 pointing device is detected, or whether both internal and external devices are active.	Auto
Internal Pointing Devices	Enables one or both built-in PS/2 devices.	Both
External Fn Key	Sets whether left-CTRL + left-ALT on an external keyboard is interpreted as the Fn key.	Enabled
IDE Controller	Enables the primary (hard drive) and secondary (optional CD-ROM drive) controllers.	Both
FDD Controller	Enables the floppy drive.	Enabled
Serial Port	Sets how the serial port is configured by the BIOS (specified or automatic).	Enabled
Base I/O address	Sets the I/O address and interrupt.	3F8h, IRQ4
Infrared Port	Sets how the infrared port is configured by the BIOS (specified or automatic).	Disabled
Mode	Sets the hardware to support SIR (Standard IR), ASK IR (amplitude shift keyed IR), or FIR (Fast IR) infrared communications. (Driver installation required.)	SIR
Base I/O address	Sets the I/O address and interrupt.	2F8h, IRQ3
DMA channel	For Fast IR mode, sets the DMA channel.	DMA3
Parallel Port	Sets how the parallel port is configured by the BIOS (specified or automatic).	Enabled
Mode	Sets the port to normal, bi-directional, EPP, or ECP.	ECP
Base I/O address	Sets the I/O address.	378h
Interrupt	Sets the interrupt.	IRQ7
DMA channel	For ECP mode, sets the DMA channel.	DMA3
OmniBook 4100/4150†: Audio	Sets how the audio system is configured by the BIOS (specified or automatic).	Enabled
SB I/O address	Sets the Sound Blaster I/O address.	220h
WSS I/O address	Sets the Windows Sound System I/O address.	530h
AdLib I/O address	Sets the AdLib synthesizer I/O address.	388h
Interrupt	Sets the interrupt.	IRQ5
1st DMA channel	Sets the DMA channel for playback.	DMA1
2nd DMA channel	Sets the DMA channel for recording.	DMA0
Security Menu		Default
User Password Is	Shows if a user password is set.	Clear
Administrator Password Is	Shows if an administrator password is set.	Clear
Set User Password	Press ENTER to set, change, or clear user password. Password length can be no longer than 8 characters, 0-9, A-Z.	
Set Administrator Password	Press ENTER to set, change, or clear administrator password. This password protects BIOS Setup settings.	
Boot	Sets whether a password is required when the computer boots.	Enabled
Resume	If boot security is enabled, sets whether a password is required when resuming from a suspended state.	Enabled
Undock	If boot security is enabled, sets whether a password is required when undocking the OmniBook.	Disabled
Internal Hard Disk Drive Lock	If boot security is enabled, sets whether a password is stored on the hard disk. Secures data on the disk if the disk is moved to another computer.	Disabled
Removable Device Boot	Sets whether the floppy drive or other removable device is a boot device.	Enabled

Power Menu		Default
If ACPI is activated in Windows 98, ACPI settings override settings in this menu.		
Power Management Mode	Disables time-outs, selects a combination of time-outs, or allows customized time-outs.	Max Power Savings
Smart CPU Mode	Enables automatic CPU power savings when running on battery power. Absence of keyboard, mouse, and hard disk activity could cause slower CPU response. For OmniBook 4100/4150†, this should normally be Off to avoid interfering with time sensitive operations, and the setting applies on ac power.	OB 4150B: On OB 4100/4150†: Off
Standby Time-out	Sets the period of inactivity after which the computer goes from On to Standby power mode.	2 minutes
Suspend Time-out	Sets the period of inactivity after which the computer goes from Standby to Suspend power mode. (Skips Standby mode if that time-out is disabled.)	4 minutes
Hibernate Time-out	Sets whether the computer goes from Suspend to Hibernate power mode after the indicated period of inactivity. (Skips Suspend mode if that time-out is disabled.)	4 hours
Hard Disk Time-out	Sets the period of hard disk inactivity after which the hard disk stops spinning. Also affects a hard disk drive in the plug-in module bay.	2 minutes
Time-out on AC	Sets whether power management time-outs occur while the ac adapter is connected.	Disabled
Power Button Mode	Sets the action of the blue power button when pressed for less than 4 seconds.	Suspend
BIOS Version 2.xx/3.xx: Lid Switch Mode	Sets the action when the OmniBook lid closes.	Turn Off LCD
Resume on Serial (or Modem) Ring	Sets whether the system resumes from Suspend if a ring signal is received.	Enabled
Resume on Time of Day	Sets whether the system resumes from Suspend at a defined time of day.	Disabled
Resume Time	Sets the 24-hour time when the system resumes from Suspend if enabled.	
Auto Suspend on Undock	Sets whether the OmniBook suspends after undocking.	When Lid Closed
BIOS Version 2.xx/3.xx: Auto Turn-On on Dock	Sets whether the OmniBook turns on after docking.	Enabled
Boot Menu		Default
+Removable Device +Hard Drive CD-ROM/DVD Drive	Shows the order of boot devices. Move the entries to change the order. If the computer has more than one device in one of the "+" categories, you can select the one that is scanned.	1. Removable Device 2. Hard drive 3. CD-ROM/DVD drive
Exit Menu		
Save Changes and Exit	Saves Setup changes, exits, and reboots.	
Discard Changes and Exit	Discards Setup changes since last save, exits, and reboots. Does not affect Security and date/time changes.	
Get Default Values	Restores default settings, stays in Setup. Does not affect Security and date/time settings.	
Load Previous Values	Discards Setup changes since last save, stays in Setup. Does not affect Security and date/time changes.	
Save Changes	Saves Setup changes, and stays in Setup. Security settings are saved when changed.	
† Models called 4150† in this manual have no marking in the serial number, whereas models called 4150B have 4150 B after the serial number.		

Replaceable Parts

This chapter contains an exploded view of the OmniBook and the following lists of parts:

- OmniBook replaceable parts (page 4-2).
- Assembly-component breakout (page 4-8)
- Accessory replacement parts (page 4-9).
- Part number reference (page 4-10).

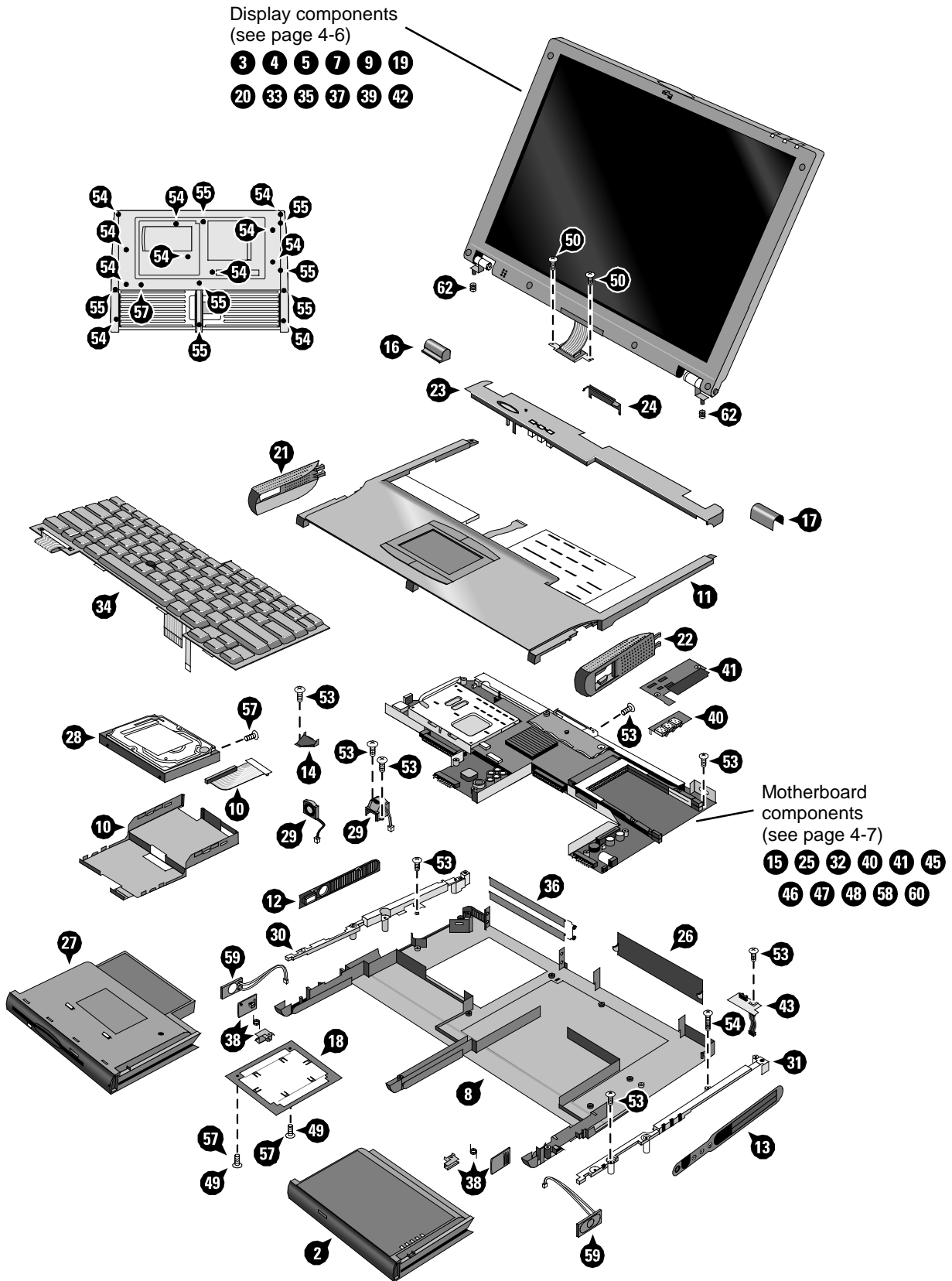

Figure 4-1. Exploded View

Table 4-1. OmniBook Replaceable Parts

	Description	Part Number	Exchange Part Number	User-Repl.	OmniBook		
					4150B	4150†	4100
2	Battery, 4200mAh (Molicell)	F1466-60903		Yes	•	•	•
2	Battery, 4200mAh (Sony)	F1466-80002		Yes	•	•	•
2	Battery, 5100mAh (Molicell)	F1660-60927		Yes	•	•	•
2	Battery, 5100mAh (Sony)	F1660-60926		Yes	•	•	•
3	Bezel, display (Hyundai 13")	F1655-60915			•		
3	Bezel, display (IBM 14")	F1462-60927					•
3	Bezel, display (IBM 14")	F1629-60919				•	
3	Bezel, display (IBM, CPT, LG/B 14")	F1660-60911			•	•	
3	Bezel, display (LG 14")	F1460-60967					•
3	Bezel, display (LG 14")	F1629-60909				•	
3	Bezel, display (Samsung 13")	F1460-60969					•
4	Cable, LCD flex (CPT 14")	F1660-60920			•		
4	Cable, LCD flex (Hyundai 13")	F1660-60922			•		
4	Cable, LCD flex (IBM 14")	F1629-60915				•	•
4	Cable, LCD flex (IBM74E 14")	F1660-60921			•		
4	Cable, LCD flex (IBM76, LG 14")	F1660-60913			•		
4	Cable, LCD flex (LG 14")	F1460-60981				•	•
4	Cable, LCD flex (Samsung 13")	F1460-60975					•
5	Cable, LED strip (IBM, CPT, LG/B 14")	F1629-60916			•	•	•
5	Cable, LED strip (LG 14", Samsung 13")	F1460-60972				•	•
7	Cap, end (display)	F1462-60924			•	•	•
	Cap, pointing stick	F1320-60971		Yes	•	•	•
8	Case, bottom *	F1460-60961				•	•
8	Case, bottom *	F1660-60910			•		
9	Case, display (13") *	F1460-60970			•		•
9	Case, display (14") *	F1460-60968			•	•	•
10	Case, HDD kit	F1460-60982			•	•	•
11	Case, top	F1460-60939			•	•	•
12	Cover, air vent (and PS/2, USB)	F1460-60956				•	•
12	Cover, air vent (and PS/2, USB)	F1660-60906			•		
13	Cover, audio jack	F1460-60959			•	•	•
14	Cover, heat exchange (fan)	F1460-60955				•	•
15	Cover, heatsink (for M2 screw)	F1460-60952					•
15	Cover, heatsink (for M3 screw)	F1629-60914				•	•
16	Cover, hinge (left)	F1460-60941		Yes		•	•
16	Cover, hinge (left)	F1660-60901		Yes	•		
17	Cover, hinge (right)	F1460-60940		Yes	•	•	•
18	Cover, RAM/BIOS	F1460-80013		Yes			•
18	Cover, RAM/BIOS	F1629-80001		Yes	•	•	
19	Cover, screw (lower, flat)	F1462-60922		Yes	•	•	•
20	Cover, screw (upper, domed)	F1462-60923		Yes	•	•	•
21	Cover, speaker (left) *	F1460-60945		Yes	•	•	•
22	Cover, speaker (right) *	F1460-60944		Yes	•	•	•
23	Cover, strip (top case)	F1460-60942				•	•
23	Cover, strip (top case)	F1660-60902			•		
24	Cover, VGA connector	F1460-60943		Yes	•	•	•
25	CPU module (MMO), 233MHz Pentium II (MD)*	1821-4303	F1440-69103				•

	Description	Part Number	Exchange Part Number	User-Repl.	OmniBook		
					4150B	4150†	4100
25	CPU module (MMO), 266MHz Pentium (T)*	1821-4302	F1440-69102				•
25	CPU module (MMO), 266MHz Pentium II (MD)*	1821-4304	F1440-69104				•
25	CPU module (MMO), 300MHz Pentium II (MD)*	1821-4487	F1440-69106			•	
25	CPU module (MMO), 333MHz Pentium II (D)*	1821-4932	F1640-69101			•	
25	CPU module (MMO), 366MHz Pentium II (D)*	1821-4933	F1640-69102		•	•	
25	CPU module (MMO), 400MHz Pentium II (D)*	1821-5204	F1640-69103		•	•	
26	Door, I/O	F1460-60965		Yes	•	•	•
27	Drive, floppy disk module (no cable)	F1472-80001		Yes	•	•	•
28	Drive, hard disk (4.0GB, 12.7mm, IBM)	0950-2671	F1386-69100	Yes			•
28	Drive, hard disk (4.0GB, 12.7mm, Toshiba)	0950-2865	F1386-69101	Yes			•
28	Drive, hard disk (4.3GB, 9.5mm, IBM)	0950-3409	F1711-69100	Yes		•	•
28	Drive, hard disk (4.8GB, 9.5mm, IBM) **	0950-3611	F1711-69102	Yes	•	•	•
28	Drive, hard disk (6.4GB, 9.5mm, IBM) **	0950-3442	F1711-69101	Yes	•	•	•
28	Drive, hard disk (6.4GB, 12.7mm, IBM)	0950-2785	F1475-69100	Yes		•	•
28	Drive, hard disk (6.4GB, 8.4mm, Toshiba)	0950-3675	F1475-69102	Yes	•	•	•
28	Drive, hard disk (6.4GB, 12.7mm, Toshiba)	0950-3397	F1475-69101	Yes		•	•
28	Drive, hard disk (10.1 GB, 12.5mm, IBM) **	0950-3443	F1744-69101	Yes	•	•	
29	Fan	F1460-60954				•	•
29	Fan	F1660-60904			•		
	Foot, rubber	F1460-60991		Yes	•	•	•
30	Frame, left	F1460-60957			•	•	•
31	Frame, right	F1460-60958			•	•	•
32	Heatsink, finned (M2, for 2-screw top plate,)	F1460-60953					•
32	Heatsink, finned (M3, for 2-screw top plate,)	F1629-60913				•	•
32	Heatsink, finned (for 5-screw top plate)	F1640-60910				•	
32	Heatsink/top plate	F1660-60903			•		
33	Hinges, display (left and right)	F1460-60973			•	•	•
	IC, BIOS, Pentium II (MD, D)	F1460-12007					•
	IC, BIOS, Pentium (T)	F1460-12016					•
34	Keyboard, Czech	F1649-60916			•	•	•
34	Keyboard, Danish	F1649-60914			•	•	•
34	Keyboard, French	F1649-60909			•	•	•
34	Keyboard, French-Canadian	F1649-60906			•	•	•
34	Keyboard, German	F1649-60907			•	•	•
34	Keyboard, Greek	F1649-60903			•	•	•
34	Keyboard, International English	F1649-60902			•	•	•
34	Keyboard, Italian	F1649-60915			•	•	•
34	Keyboard, Japanese	F1649-60910			•	•	•
34	Keyboard, Norwegian	F1649-60911			•	•	•
34	Keyboard, Spanish	F1649-60908			•	•	•
34	Keyboard, Swedish/Finnish	F1649-60913			•	•	•
34	Keyboard, Swiss	F1649-60912			•	•	•
34	Keyboard, Turkish	F1649-60904			•	•	•
34	Keyboard, UK English	F1649-60905			•	•	•
34	Keyboard, US English	F1649-60901			•	•	•
35	Kit, display case (latch, spring, cable holder/cover)	F1460-60971			•	•	•
36	Kit, dock door (doors, springs)	F1460-60964		Yes	•	•	•
37	Kit, LCD (shield, brackets) (CPT 14")	F1660-60918			•		

	Description	Part Number	Exchange Part Number	User-Repl.	OmniBook		
					4150B	4150†	4100
37	Kit, LCD (shield, brackets) (Hyundai 13")	F1660-60919			•		
37	Kit, LCD (shield, brackets) (IBM74 14")	F1629-60932				•	•
37	Kit, LCD (shield, brackets) (IBM74E 14")	F1640-60909			•	•	
37	Kit, LCD (shield, brackets) (IBM76, LG 14")	F1660-60915			•		
37	Kit, LCD (shield, brackets) (LG 14")	F1460-60980				•	•
37	Kit, LCD (shield, brackets) (Samsung 13")	F1460-60974					•
38	Kit, module latch (latches, sliders, springs)	F1460-60963			•	•	•
	Label, regulatory/business card	F1460-60962					•
	Label, regulatory/business card	F1629-60910			•	•	
39	LCD module (CPT 14")	F1660-60930	F1660-69030		•		
39	LCD module (Hyundai 13") *	F1655-60920	F1655-69020		•		
39	LCD module (IBM74 14")	F1629-60912	F1629-69012			•	•
39	LCD module (IBM74E 14")	F1640-60908	F1640-69008		•	•	
39	LCD module (IBM76 14")	F1660-60928	F1660-69028		•		
39	LCD module (LG 14")	F1440-60995	F1440-69095			•	•
39	LCD module (LG 14")	F1660-60929	F1660-69029		•		
39	LCD module (Samsung 13") *	F1460-60998	F1460-69098				•
	Module, filler	F1460-80015		Yes	•	•	•
	Overlay, serial number	7121-7525			•	•	•
40	PCA, audio jack	F1460-60913				•	•
40	PCA, audio jack	F1660-60907			•		
41	PCA, DC-DC	F1460-60912					•
41	PCA, DC-DC	F1629-60906				•	
41	PCA, DC-DC	F1660-60917			•		
42	PCA, inverter (all 13")	F1460-60917			•		•
42	PCA, inverter (IBM 14")	F1629-60917				•	•
42	PCA, inverter (IBM74E 14")	F1660-60924			•		
42	PCA, inverter (IBM76, LG, CPT 14")	F1660-60912			•		
42	PCA, inverter (LG 14")	F1460-60918					•
42	PCA, inverter (LG 14")	F1629-60908				•	
43	PCA, IR	F1460-60911					•
43	PCA, IR	F1629-60905				•	
43	PCA, IR	F1660-60905			•		
44	PCA, LVDS (IBM 14")	F1462-60926					•
44	PCA, LVDS (IBM 14")	F1629-60918				•	
44	PCA, LVDS (LG 14")	F1460-60916					•
44	PCA, LVDS (LG 14")	F1629-60907				•	
44	PCA, LVDS (Samsung 13")	F1460-60914					•
45	PCA, motherboard, Pentium (T) *	F1460-60902	F1460-69002				•
45	PCA, motherboard, Pentium II (MD) *	F1460-60904	F1460-69004				•
45	PCA, motherboard, Pentium II C2 (MD)* ***	F1629-60901	F1629-69001			•	
45	PCA, motherboard, Pentium II C2 (MD, D)* ***	F1640-60901	F1640-69001			•	
45	PCA, motherboard*	F1660-60909	F1660-69009		•		
46	PCA, VGA	F1460-60906					•
46	PCA, VGA	F1629-60903				•	
46	PCA, VGA	F1660-60908			•		
47	Plate, CPU bottom (Rev 4)	F1460-60949				•	•
47	Plate, CPU bottom	F1629-80003				•	
48	Plate, CPU top (2-screw), Pentium (T)	F1460-60951					•

	Description	Part Number	Exchange Part Number	User-Repl.	OmniBook		
					4150B	4150†	4100
48	Plate, CPU top (2-screw), Pentium II (MD)	F1460-60950				•	•
48	Plate, CPU top (5-screw), Pentium II (MD, D)	F1640-80002				•	
	RAM module (see table on page 4-9)						
	Screw, M2x3mm	F1440-60988			•		
49	Screw, M2x3.5mm	F1640-60912			•	•	•
50	Screw, M2x4mm	F1460-60989			•	•	•
61	Screw, M2x5mm	F1640-60913			•	•	
63	Screw, M2x12mm	F1440-60981			•		
51	Screw, M2x14mm	F1460-60988				•	•
52	Screw, M2.5x4mm	F1460-60990			•	•	•
53	Screw, M2.5x5mm	F1460-60984			•	•	•
54	Screw, M2.5x16mm	F1460-60986			•	•	•
55	Screw, M2.5x19mm	F1460-60985			•	•	•
57	Screw, M3x4mm	F1629-60911			•	•	•
64	Screw/spring, M2 (CPU)	F1660-60914			•		
58	Socket, PCMCIA	F1460-60919			•	•	•
	Spacer, CPU Pentium II (MD)	F1462-80003					•
	Spacer, LCD connector (all 13")	F1462-60925			•		•
	Spacer, top plate	F1460-80018					•
	Spacer, VGA PCA (rubber)	F1640-60944				•	
	Spacer kit, for 8.4mm HDD (top and end)	F1629-60933		Yes	•	•	•
	Spacer, for 9.5mm HDD (top)	F1629-60934		Yes	•	•	•
59	Speaker	F1460-60960			•	•	•
62	Spring, display ground	F1462-60928			•	•	•
60	Standoff, VGA	F1440-60976			•	•	•
	Tape, Kapton, 0.75" x 36 yards	F1391-60963			•	•	•
	Thermal pad, CPU notched (T, MD)	5182-5153				•	•
	Thermal pad, large Pentium (T)	F1463-80001					•
	Thermal pad, medium Pentium (T)	F1463-80002					•
	Thermal pad, small Pentium (T)	F1463-80003					•
	Thermal pad, square Pentium II (MD)	F1462-80004				•	•
	Thermal pad, notched (heatsink, top plate)	F1640-60911			•	•	
<p>* See Table 4-2 for components.</p> <p>** These hard drives are the preferred drives at the time of publication. Drives shipped in units are subject to change without notice. For current information about preferred and approved drives for these products, see the latest version of service note HDD-01.</p> <p>*** For serial numbers below TW85299999, use F1629-69001. For serial numbers above TW90100000, use F1640-69001.</p>							

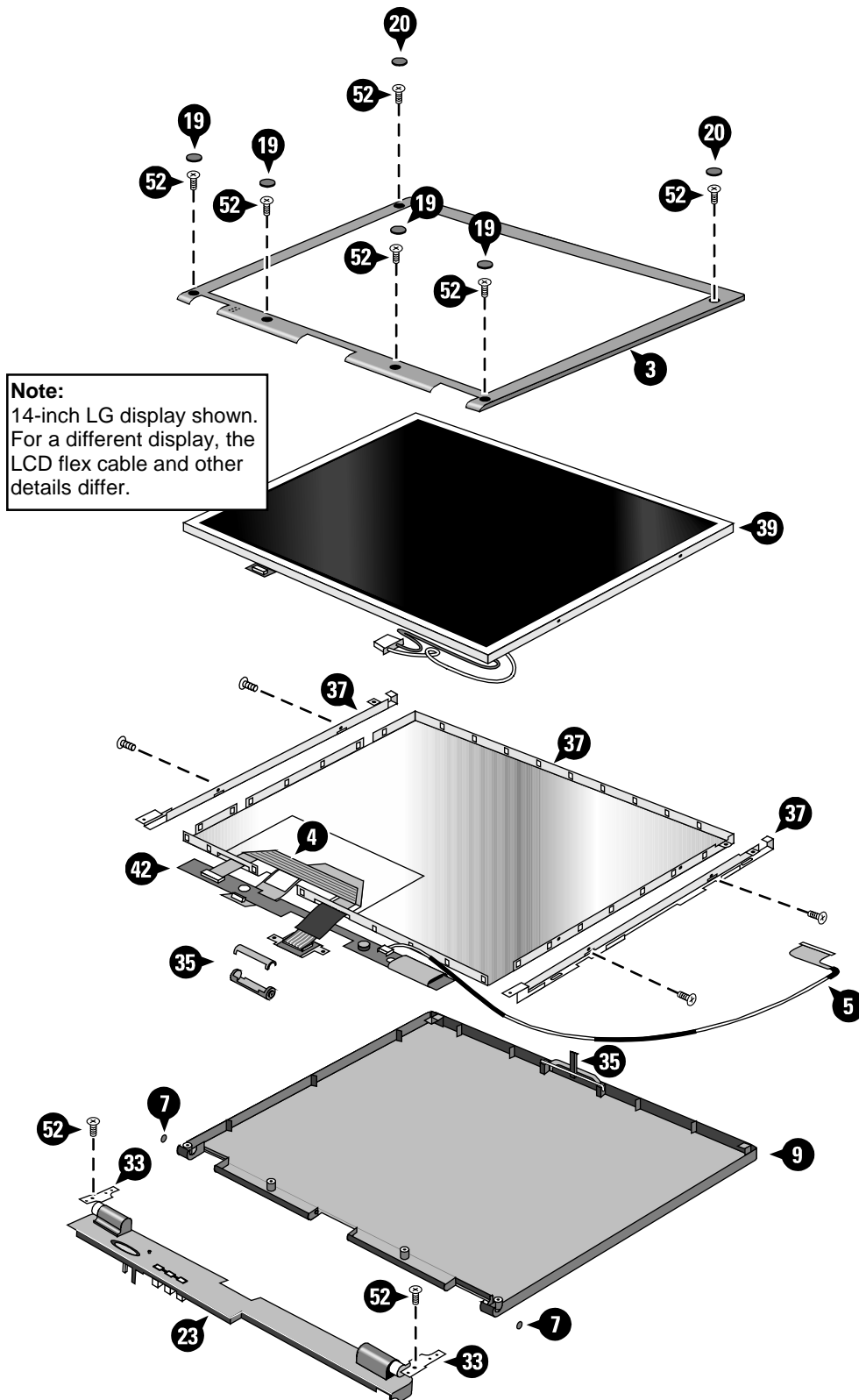

Figure 4-2. Display Components

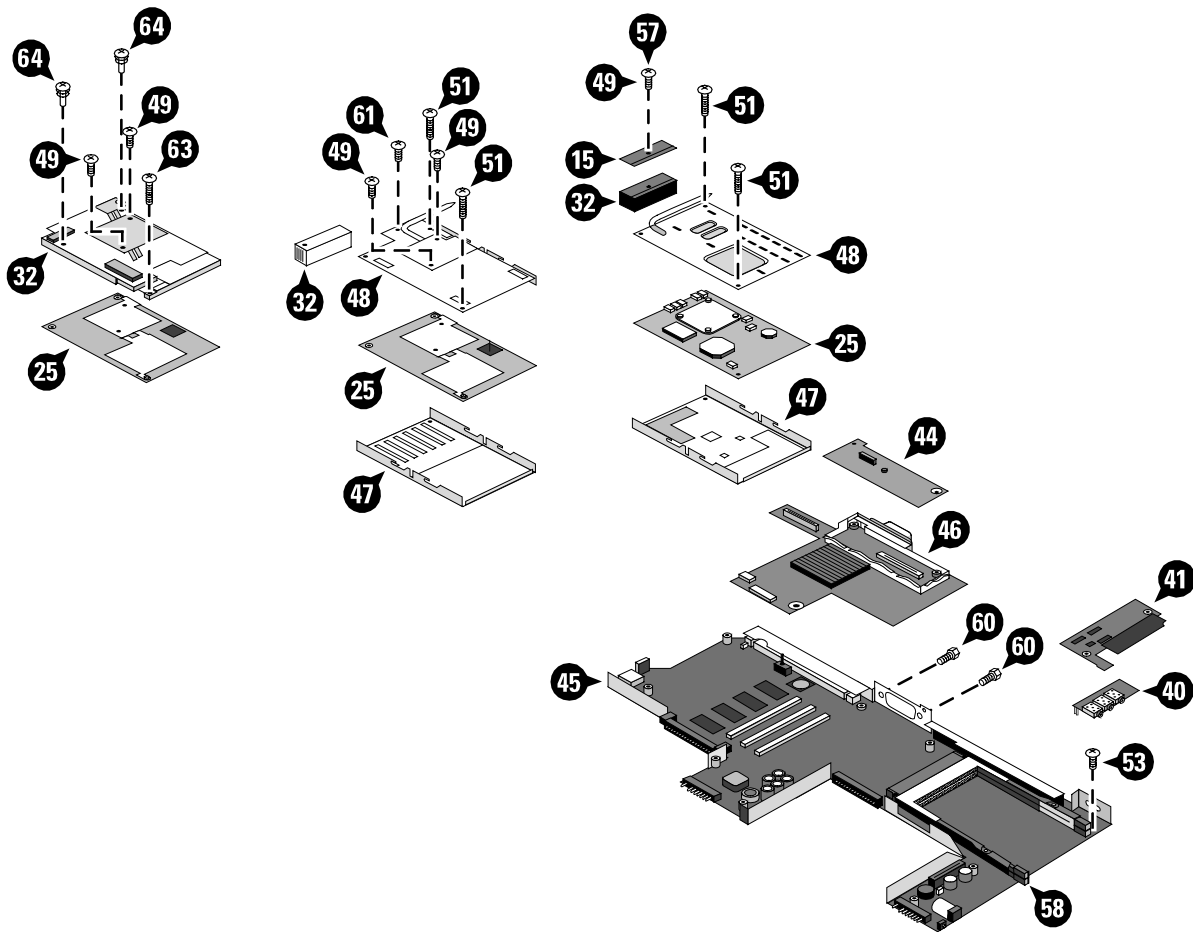

Figure 4-3. Motherboard Components

Table 4-2. Assembly-Component Breakdown

Assembly	Part Number	Components	Part Number	Incl.
Case, bottom	(all)	Cover, RAM/BIOS	(all)	No
		Docking doors	F1460-60964	No
		Feet (2)	F1460-60991	Yes
		I/O door	F1460-60965	No
		Label, regulatory/ business card	(all)	No
		Overlay, serial number	7121-7525	No
		Module latches	F1460-60963	No
Case, display	(all)	Display kit (latch, cable holder)	F1460-60971	No
Cover, speaker	(all)	Foot (1)	F1460-60991	Yes
CPU module (MMO)	(all)	Thermal pads	(all)	No
LCD module (all 13")	(all)	Spacer, LCD connector	F1462-60925	No
PCA, motherboard	(all)	BIOS IC	(all)	Yes
		PCMCIA socket	F1460-60919	Yes

Table 4-3. Accessory Replaceable Parts

Description	Part Number	Exchange Part Number	User Repl.	OmniBook		
				4150B	4150†	4100
Adapter, ac (60W)	0950-2790		Yes	•	•	•
Adapter, auto plug (from airline)	5182-5131		Yes	•	•	•
Adapter, auto/airline (75W)	F1455-80003		Yes	•	•	•
Adapter, docking module bay	F1468-60901		Yes	•	•	•
Adapter, PS/2 "Y"	F1469-80001		Yes	•	•	•
Battery, 4200mAh (Molicell)	F1466-60903		Yes	•	•	•
Battery, 4200mAh (Sony)	F1466-80002		Yes	•	•	•
Battery, 5100mAh (Molicell)	F1660-60927		Yes	•	•	•
Battery, 5100mAh (Sony)	F1660-60926		Yes	•	•	•
Cable, external FDD	F1473-80003		Yes	•	•	•
Cable, MPEG PC card	F1465-60904		Yes		•	•
Card, PC (MPEG)	F1465-60902		Yes		•	•
CD, DVD player (MPEG)	F1465-60903		Yes		•	•
Charger, battery (external)	F1620-60902		Yes	•	•	•
Docking system (with tall monitor stand)	(see dock service manual)		Yes	•	•	•
Drive, CD-ROM module	F1474-80001		Yes	•	•	•
Drive, DVD module	F1465-80001		Yes	•	•	•
Drive, floppy disk module (no cable)	F1472-80001		Yes	•	•	•
Drive, LS-120 module	F1470-80001		Yes	•	•	•
Drive, second HDD housing	F1746-80001		Yes	•	•	•
Drive, DVD (4X)	F1653-80001		Yes	•	•	•
Mini dock	F1452-60901		Yes	•	•	•
Module, filler	F1460-80015		Yes	•	•	•
Monitor stand (short)	F1453-60901		Yes	•	•	•
Monitor stand (tall)	(see dock service manual)		Yes	•	•	•
Port replicator	F1451-60901		Yes	•	•	•
RAM board, 32MB SDRAM (66 MHz)	1818-7413	F1456-69001	Yes		•	•
RAM board, 64MB SDRAM (66 MHz)	1818-7414	F1457-69001	Yes		•	•
RAM board, 128MB SDRAM (66 MHz)	1818-7549	F1622-69001	Yes		•	•
RAM board, 32MB SDRAM (100 MHz)	1818-7950		Yes	•	•	•
RAM board, 64MB SDRAM (100 MHz)	1818-7951		Yes	•	•	•
RAM board, 128MB SDRAM (100 MHz)	1818-7952		Yes	•	•	•
† Models called 4150† in this manual have no marking in the serial number, whereas models called 4150B have 4150 B after the serial number.						

Table 4-4. Part Number Reference

Part Number	Exchange Part Number	Description	User Repl.	OmniBook		
				4150B	4150†	4100
0950-2671	F1386-69100	Drive, hard disk (4.0GB, 12.7mm, IBM)			•	•
0950-2785	F1475-69100	Drive, hard disk (6.4GB, 12.7mm, IBM)			•	•
0950-2790		Adapter, ac (60W)	Yes	•	•	•
0950-2865	F1386-69101	Drive, hard disk (4.0GB, 12.7mm, Toshiba)	Yes			•
0950-3397	F1475-69101	Drive, hard disk (6.4GB, 12.7mm, Toshiba)	Yes		•	•
0950-3409	F1711-69100	Drive, hard disk (4.3GB, 9.5mm, IBM)	Yes		•	•
0950-3442	F1711-69101	Drive, hard disk (6.4GB, 9.5mm, IBM) *	Yes	•	•	•
0950-3443	F1744-69101	Drive, hard disk (10.1GB, 12.5mm, IBM) *	Yes	•	•	
0950-3611	F1711-69102	Drive, hard disk (4.8GB, 9.5mm, IBM)*	Yes	•	•	•
0950-3675	F1475-69102	Drive, hard disk (6.4GB, 8.4mm, Toshiba)	Yes	•	•	•
1818-7413	F1456-69001	RAM board, 32MB SDRAM (66 MHz)	Yes		•	•
1818-7414	F1457-69001	RAM board, 64MB SDRAM (66 MHz)	Yes		•	•
1818-7549	F1622-69001	RAM board, 128MB SDRAM (66 MHz)	Yes		•	•
1818-7950		RAM board, 32 MB (100 MHz)	Yes	•	•	•
1818-7951		RAM board, 64 MB (100 MHz)	Yes	•	•	•
1818-7952		RAM board, 128 MB (100 MHz)	Yes	•	•	•
1821-4302	F1440-69102	CPU module (MMO), 266 MHz Pentium (T)				•
1821-4303	F1440-69103	CPU module (MMO), 233 MHz Pentium II (MD)				•
1821-4304	F1440-69104	CPU module (MMO), 266 MHz Pentium II (MD)				•
1821-4487	F1440-69106	CPU module (MMO), 300 MHz Pentium II (MD C2)			•	
1821-4932	F1640-69101	CPU module (MMO), 333 MHz Pentium II (D)			•	
1821-4933	F1640-69102	CPU module (MMO), 366 MHz Pentium II (D)		•	•	
1821-5204	F1640-69103	CPU module (MMO), 400MHz Pentium II (D)		•	•	
5182-5131		Adapter, auto plug (from airline)	Yes	•	•	•
5182-5153		Thermal pad, CPU notched (T, MD)			•	•
7121-7525		Overlay, serial number		•	•	•
8120-6312		Power cord, replacement (Australia).	Yes	•	•	•
8120-6313		Power cord, replacement (U.S., Canada, Taiwan).	Yes	•	•	•
8120-6314		Power cord, replacement (Europe).	Yes	•	•	•
8120-6316		Power cord, replacement (Japan).	Yes	•	•	•
8120-6317		Power cord, replacement (India, South Africa).	Yes	•	•	•
8120-8367		Power cord, replacement (Argentina).	Yes	•	•	•
8120-8373		Power cord, replacement (People's Republic of China).	Yes	•	•	•
8120-8452		Power cord, replacement (Chile).	Yes	•	•	•
8120-8699		Power cord, replacement (Hong Kong, Singapore, U.K.).	Yes	•	•	•
F1320-60971		Cap, pointing stick	Yes	•	•	•
F1391-60963		Kapton tape, 0.75" x 36 yards		•	•	•
F1440-60976		Standoff, VGA		•	•	•
F1440-60981		Screw, M2x12mm		•		
F1440-60988		Screw, M2x3mm		•		
F1440-60995	F1440-69095	LCD module (LG 14")			•	•
F1451-60901		Port replicator	Yes	•	•	•
F1452-60901		Mini dock	Yes	•	•	•
F1453-60901		Monitor stand (short)	Yes	•	•	•
F1455-80003		Adapter, auto/airline (75W)	Yes	•	•	•

Part Number	Exchange Part Number	Description	User Repl.	OmniBook		
				4150B	4150†	4100
F1460-12007		IC, BIOS, Pentium II (MD, D)				•
F1460-12016		IC, BIOS, Pentium (T)				•
F1460-60902	F1460-69002	PCA, motherboard, Pentium (T)				•
F1460-60904	F1460-69004	PCA, motherboard, Pentium II (MD)				•
F1460-60906		PCA, VGA				•
F1460-60911		PCA, IR				•
F1460-60912		PCA, DC-DC				•
F1460-60913		PCA, audio jack			•	•
F1460-60914		PCA, LVDS (Samsung 13")				•
F1460-60916		PCA, LVDS (LG 14")				•
F1460-60917		PCA, inverter (all 13")		•		•
F1460-60918		PCA, inverter (LG 14")				•
F1460-60919		Socket, PCMCIA		•	•	•
F1460-60939		Case, top		•	•	•
F1460-60940		Cover, hinge (right)	Yes	•	•	•
F1460-60941		Cover, hinge (left)	Yes		•	•
F1460-60942		Cover, strip (top case)			•	•
F1460-60943		Cover, VGA connector	Yes	•	•	•
F1460-60944		Cover, speaker (right)	Yes	•	•	•
F1460-60945		Cover, speaker (left)	Yes	•	•	•
F1460-60949		Plate, CPU bottom (Rev 4)			•	•
F1460-60950		Plate, CPU top (2-screw), Pentium II (MD)			•	•
F1460-60951		Plate, CPU top (2-screw), Pentium (T)				•
F1460-60952		Cover, heatsink (for M2 screw)				•
F1460-60953		Heatsink, finned (M2 screw, for 2-screw top plate)				•
F1460-60954		Fan			•	•
F1460-60955		Cover, heat exchange (fan)			•	•
F1460-60956		Cover, air vent (and PS/2, USB)			•	•
F1460-60957		Frame, left		•	•	•
F1460-60958		Frame, right		•	•	•
F1460-60959		Cover, audio jack		•	•	•
F1460-60960		Speaker		•	•	•
F1460-60961		Case, bottom			•	•
F1460-60962		Label, regulatory/business card				•
F1460-60963		Kit, module latch (latches, sliders, springs)		•	•	•
F1460-60964		Kit, dock door (doors, springs)	Yes	•	•	•
F1460-60965		Door, I/O	Yes	•	•	•
F1460-60967		Bezel, display (LG 14")				•
F1460-60968		Case, display (14")		•	•	•
F1460-60969		Bezel, display (Samsung 13")				•
F1460-60970		Case, display (13")		•		•
F1460-60971		Kit, display case (latch, spring, cable holder/cover)		•	•	•
F1460-60972		Cable, LED strip (LG 14", Samsung 13")			•	•
F1460-60973		Hinges, display (left and right)		•	•	•
F1460-60974		Kit, LCD (shield, brackets) (Samsung 13")				•
F1460-60975		Cable, LCD flex (Samsung 13")				•
F1460-60980		Kit, LCD (shield, brackets) (LG 14")			•	•

Part Number	Exchange Part Number	Description	User Repl.	OmniBook		
				4150B	4150†	4100
F1460-60981		Cable, LCD flex (LG 14")			•	•
F1460-60982		Case, HDD kit		•	•	•
F1460-60984		Screw, M2.5x5mm		•	•	•
F1460-60985		Screw, M2.5x19mm		•	•	•
F1460-60986		Screw, M2.5x16mm		•	•	•
F1460-60988		Screw, M2x14mm			•	•
F1460-60989		Screw, M2x4mm		•	•	•
F1460-60990		Screw, M2.5x4mm		•	•	•
F1460-60991		Foot, rubber	Yes	•	•	•
F1460-60998	F1460-69098	LCD module (Samsung 13")				•
F1460-80013		Cover, RAM/BIOS	Yes			•
F1460-80015		Module, filler	Yes	•	•	•
F1460-80018		Spacer, top plate				•
F1462-60901		OmniBook Performance 98 Group training kit		•	•	•
F1462-60910		Recovery CD, English (OB4100, W95, Spring-98)				•
F1462-60911		Recovery CD, German (OB4100, W95, Spring-98)				•
F1462-60912		Recovery CD, French (OB4100, W95, Spring-98)				•
F1462-60913		Recovery CD, Spanish (OB4100, W95, Spring-98)				•
F1462-60914		Recovery CD, Italian (OB4100, W95, Spring-98)				•
F1462-60915		Recovery CD, Swedish (OB4100, W95, Spring-98)				•
F1462-60916		Recovery CD, English (OB4100, WNT, Spring-98)				•
F1462-60917		Recovery CD, German (OB4100, WNT, Spring-98)				•
F1462-60918		Recovery CD, French (OB4100, WNT, Spring-98)				•
F1462-60919		Recovery CD, Spanish (OB4100, WNT, Spring-98)				•
F1462-60920		Recovery CD, Italian (OB4100, WNT, Spring-98)				•
F1462-60921		Recovery CD, Swedish (OB4100, WNT, Spring-98)				•
F1462-60922		Cover, screw (lower, flat)	Yes	•	•	•
F1462-60923		Cover, screw (upper, domed)	Yes	•	•	•
F1462-60924		Cap, end (display)		•	•	•
F1462-60925		Spacer, LCD connector (all 13")		•		•
F1462-60926		PCA, LVDS (IBM 14")				•
F1462-60927		Bezel, display (IBM 14")				•
F1462-60928		Spring, display ground		•	•	•
F1462-80003		Spacer, CPU Pentium II (MD)				•
F1462-80004		Thermal pad, square Pentium II (MD)			•	•
F1463-80001		Thermal pad, large Pentium (T)				•
F1463-80002		Thermal pad, medium Pentium (T)				•
F1463-80003		Thermal pad, small Pentium (T)				•
F1465-60902		Card, PC (MPEG)	Yes		•	•
F1465-60903		CD, DVD player (MPEG)	Yes		•	•
F1465-60904		Cable, MPEG PC card	Yes		•	•
F1465-80001		Drive, DVD module	Yes	•	•	•
F1466-60903		Battery, 4200mAh (Molicell)	Yes	•	•	•
F1466-80002		Battery, 4200mAh (Sony)	Yes	•	•	•
F1468-60901		Adapter, docking module bay	Yes	•	•	•
F1469-80001		Adapter, PS/2 "Y"	Yes	•	•	•
F1470-80001		Drive, LS-120 module	Yes	•	•	•

Part Number	Exchange Part Number	Description	User Repl.	OmniBook		
				4150B	4150†	4100
F1472-80001		Drive, floppy disk module (no cable)	Yes	•	•	•
F1473-80003		Cable, external FDD	Yes	•	•	•
F1474-80001		Drive, CD-ROM module	Yes	•	•	•
F1620-60902		Charger, battery (external)	Yes	•	•	•
F1629-60901	F1629-69001	PCA, motherboard, Pentium II C2 (MD)			•	
F1629-60903		PCA, VGA			•	
F1629-60905		PCA, IR			•	
F1629-60906		PCA, DC-DC			•	
F1629-60907		PCA, LVDS (LG 14")			•	
F1629-60908		PCA, inverter (LG 14")			•	
F1629-60909		Bezel, display (LG 14")			•	
F1629-60910		Label, regulatory/business card		•	•	
F1629-60911		Screw, M3x4mm		•	•	•
F1629-60912	F1629-69012	LCD module (IBM74 14")			•	•
F1629-60913		Heatsink, finned (M3 screw, for 2-screw top plate)			•	•
F1629-60914		Cover, heatsink (for M3 screw)			•	•
F1629-60915		Cable, LCD flex (IBM 14")			•	•
F1629-60916		Cable, LED strip (IBM, CPT, LG/B 14")		•	•	•
F1629-60917		PCA, inverter (IBM 14")			•	•
F1629-60918		PCA, LVDS (IBM 14")			•	
F1629-60919		Bezel, display (IBM 14")			•	
F1629-60920		Recovery CD, English (OB4150, W95/98, Fall-98)			•	
F1629-60921		Recovery CD, German (OB4150, W95/98, Fall-98)			•	
F1629-60922		Recovery CD, French (OB4150, W95/98, Fall-98)			•	
F1629-60923		Recovery CD, Spanish (OB4150, W95/98, Fall-98)			•	
F1629-60924		Recovery CD, Italian (OB4150, W95/98, Fall-98)			•	
F1629-60925		Recovery CD, Swedish (OB4150, W95/98, Fall-98)			•	
F1629-60926		Recovery CD, English (OB4150, WNT, Fall-98)			•	
F1629-60927		Recovery CD, German (OB4150, WNT, Fall-98)			•	
F1629-60928		Recovery CD, French (OB4150, WNT, Fall-98)			•	
F1629-60929		Recovery CD, Spanish (OB4150, WNT, Fall-98)			•	
F1629-60930		Recovery CD, Italian (OB4150, WNT, Fall-98)			•	
F1629-60931		Recovery CD, Swedish (OB4150, WNT, Fall-98)			•	
F1629-60932		Kit, LCD (shield, brackets) (IBM74 14")			•	•
F1629-60933		Spacer kit, for 8.4mm HDD (top and end)	Yes	•	•	•
F1629-60934		Spacer, for 9.5mm HDD (top)	Yes	•	•	•
F1629-80001		Cover, RAM/BIOS	Yes	•	•	
F1629-80003		Plate, CPU bottom			•	
F1640-60901	F1640-69001	PCA, motherboard, Pentium II C2 (MD, D)			•	
F1640-60908	F1640-69008	LCD module (IBM74E 14")		•	•	
F1640-60909		Kit, LCD (shield, brackets) (IBM74E 14")		•	•	
F1640-60910		Heatsink, finned (for 5-screw top plate)			•	
F1640-60911		Thermal pad, notched (heatsink, top plate)		•	•	
F1640-60912		Screw, M2x3.5mm		•	•	•
F1640-60913		Screw, M2x5mm			•	
F1640-60921		Recovery CD, English (OB4150, W95/98, Wntr-98)			•	
F1640-60922		Recovery CD, German (OB4150, W95/98, Wntr-98)			•	

Part Number	Exchange Part Number	Description	User Repl.	OmniBook		
				4150B	4150†	4100
F1640-60923		Recovery CD, Spanish (OB4150, W95/98, Wntr-98)			•	
F1640-60924		Recovery CD, French (OB4150, W95/98, Wntr-98)			•	
F1640-60925		Recovery CD, Japanese (OB4150, W95/98, Wntr-98)			•	
F1640-60926		Recovery CD, Norwegian (OB4150, W95/98, Wntr-98)			•	
F1640-60927		Recovery CD, Swedish (OB4150, W95/98, Wntr-98)			•	
F1640-60928		Recovery CD, Finnish (OB4150, W95/98, Wntr-98)			•	
F1640-60929		Recovery CD, Danish (OB4150, W95/98, Wntr-98)			•	
F1640-60930		Recovery CD, Italian (OB4150, W95/98, Wntr-98)			•	
F1640-60931		Recovery CD, Chinese, (OB4150, W95/98, Wntr-98)			•	
F1640-60933		Recovery CD, English (OB4150, WNT, Wntr-98)			•	
F1640-60934		Recovery CD, German (OB4150, WNT, Wntr-98)			•	
F1640-60935		Recovery CD, Spanish (OB4150, WNT, Wntr-98)			•	
F1640-60936		Recovery CD, French (OB4150, WNT, Wntr-98)			•	
F1640-60937		Recovery CD, Japanese (OB4150, WNT, Wntr-98)			•	
F1640-60938		Recovery CD, Norwegian (OB4150, WNT, Wntr-98)			•	
F1640-60939		Recovery CD, Swedish (OB4150, WNT, Wntr-98)			•	
F1640-60940		Recovery CD, Finnish (OB4150, WNT, Wntr-98)			•	
F1640-60941		Recovery CD, Danish (OB4150, WNT, Wntr-98)			•	
F1640-60942		Recovery CD, Italian (OB4150, WNT, Wntr-98)			•	
F1640-60943		Recovery CD, Chinese (OB4150, WNT, Wntr-98)			•	
F1640-60944		Spacer, VGA PCA (rubber)			•	
F1640-80002		Plate, CPU top (5-screw), Pentium II (MD, D), w/pad			•	
F1649-60901		Keyboard, US English		•	•	•
F1649-60902		Keyboard, International English		•	•	•
F1649-60903		Keyboard, Greek		•	•	•
F1649-60904		Keyboard, Turkish		•	•	•
F1649-60905		Keyboard, UK English		•	•	•
F1649-60906		Keyboard, French-Canadian		•	•	•
F1649-60907		Keyboard, German		•	•	•
F1649-60908		Keyboard, Spanish		•	•	•
F1649-60909		Keyboard, French		•	•	•
F1649-60910		Keyboard, Japanese		•	•	•
F1649-60911		Keyboard, Norwegian		•	•	•
F1649-60912		Keyboard, Swiss		•	•	•
F1649-60913		Keyboard, Swedish/Finnish		•	•	•
F1649-60914		Keyboard, Danish		•	•	•
F1649-60915		Keyboard, Italian		•	•	•
F1649-60916		Keyboard, Czech		•	•	•
F1653-80001		Drive, DVD (4X)	Yes	•	•	•
F1655-60915		Bezel, display (Hyundai 13")		•		
F1655-60920	F1655-69020	LCD module (Hyundai 13")		•		
F1660-60901		Cover, hinge (left)	Yes	•		
F1660-60902		Cover, strip (top case)		•		
F1660-60903		Heatsink/top plate		•		
F1660-60904		Fan		•		
F1660-60905		PCA, IR		•		
F1660-60906		Cover, air vent (and PS/2, USB)		•		

Part Number	Exchange Part Number	Description	User Repl.	OmniBook		
				4150B	4150†	4100
F1660-60907		PCA, audio jack		•		
F1660-60908		PCA, VGA		•		
F1660-60909	F1660-69009	PCA, motherboard		•		
F1660-60910		Case, bottom		•		
F1660-60911		Bezel, display (IBM, CPT, LG/B 14")		•	•	
F1660-60912		PCA, inverter (IBM76, LG, CPT 14")		•		
F1660-60913		Cable, LCD flex (IBM76, LG 14")		•		
F1660-60914		Screw/spring, M2 (CPU)		•		
F1660-60915		Kit, LCD (shield, brackets) (IBM76, LG 14")		•		
F1660-60917		PCA, DC-DC		•		
F1660-60918		Kit, LCD (shield, brackets) (CPT 14")		•		
F1660-60919		Kit, LCD (shield, brackets) (Hyundai 13")		•		
F1660-60920		Cable, LCD flex (CPT 14")		•		
F1660-60921		Cable, LCD flex (IBM74E 14")		•		
F1660-60922		Cable, LCD flex (Hyundai 13")		•		
F1660-60924		PCA, inverter (IBM74E 14")		•		
F1660-60926		Battery, 5100mAh (Sony)	Yes	•	•	•
F1660-60927		Battery, 5100mAh (Molicell)	Yes	•	•	•
F1660-60928	F1660-69028	LCD module (IBM76 14")		•		
F1660-60929	F1660-69029	LCD module (LG 14")		•		
F1660-60930	F1660-69030	LCD module (CPT 14")		•		
F1660-60932		Recovery CD, Chinese (OB4150B, W95/98, Fall-99)		•		
F1660-60933		Recovery CD, Greek (OB4150B, W95/98, Fall-99)		•		
F1660-60934		Recovery CD, Turkish (OB4150B, W95/98, Fall-99)		•		
F1660-60935		Recovery CD, English (OB4150B, W95/98, Fall-99)		•		
F1660-60936		Recovery CD, German (OB4150B, W95/98, Fall-99)		•		
F1660-60937		Recovery CD, Spanish (OB4150B, W95/98, Fall-99)		•		
F1660-60938		Recovery CD, French (OB4150B, W95/98, Fall-99)		•		
F1660-60939		Recovery CD, Japanese (OB4150B, W95/98, Fall-99)		•		
F1660-60940		Recovery CD, Norwegian (OB4150B, W95/98, Fall-99)		•		
F1660-60941		Recovery CD, Swedish (OB4150B, W95/98, Fall-99)		•		
F1660-60942		Recovery CD, Finnish (OB4150B, W95/98, Fall-99)		•		
F1660-60943		Recovery CD, Danish (OB4150B, W95/98, Fall-99)		•		
F1660-60944		Recovery CD, Italian (OB4150B, W95/98, Fall-99)		•		
F1660-60945		Recovery CD, Czech (OB4150B, W95/98, Fall-99)		•		
F1660-60950		Recovery CD, English (OB4150B, WNT, Fall-99)		•		
F1660-60951		Recovery CD, German (OB4150B, WNT, Fall-99)		•		
F1660-60952		Recovery CD, Spanish (OB4150B, WNT, Fall-99)		•		
F1660-60953		Recovery CD, French (OB4150B, WNT, Fall-99)		•		
F1660-60954		Recovery CD, Japanese (OB4150B, WNT, Fall-99)		•		
F1660-60955		Recovery CD, Norwegian (OB4150B, WNT, Fall-99)		•		
F1660-60956		Recovery CD, Swedish (OB4150B, WNT, Fall-99)		•		
F1660-60957		Recovery CD, Finnish (OB4150B, WNT, Fall-99)		•		
F1660-60958		Recovery CD, Danish (OB4150B, WNT, Fall-99)		•		
F1660-60959		Recovery CD, Italian (OB4150B, WNT, Fall-99)		•		
F1660-60960		Recovery CD, Czech (OB4150B, WNT, Fall-99)		•		

Part Number	Exchange Part Number	Description	User Repl.	OmniBook		
				4150B	4150†	4100
F1746-80001		Drive, second HDD housing	Yes	•	•	
T-335665		Tool, CPU removal			•	
<p>* These drives are the preferred drives at the time of publication. Drives shipped in units are subject to change without notice. For current information about preferred and approved drives for these products, see the latest version of service note HDD-01.</p> <p>† Models called 4150† in this manual have no marking in the serial number, whereas models called 4150B have 4150 B after the serial number.</p>						

Reference Information

This chapter includes the following reference information:

- Password removal policy.
- Display quality statement.

Password Removal Policy

If the user forgets the system password, the user calls Technical Support to determine the proper removal procedure. The user must provide proof of ownership, and the OmniBook must be operated during the procedure.

The password removal procedure is protected as HP Company Private information. There are a restricted number of locations that can perform password removal. It may not be disclosed or distributed outside those locations.

Password removal is strictly controlled. Hewlett-Packard and authorized support providers must ensure with written evidence that the OmniBook being “cleansed” is actually in the possession of the unit’s actual and current owner. This requires a sales receipt showing the unit serial number and owner’s name, or a written statement from the owner attesting that he or she is the owner of the unit. The statement can be a fax copy of the document. The fact that the unit is in the hands of an HP representative on behalf of the customer is not evidence of ownership. In addition, HP will not remove the password of a unit for any non-owner, even if it is requested by law enforcement agencies. If you receive such a request, you should notify management and HP Corporate Legal immediately. (These requests may require a court order prior to our participation.)

Further, the entity removing the password must log the name, serial number and date of the removal, and file the written backup with the log. The log and backup are subject to standard record retention process and review.

The final issue relating to removal of passwords is that HP cannot provide information to users that would assist them in improperly removing a password and opening a unit.

Hewlett-Packard Display Quality Statement

TFT display manufacturing is a high precision but imperfect technology and manufacturers cannot currently produce large displays that are cosmetically perfect. Most, if not all, TFT displays will exhibit some level of cosmetic imperfection. These cosmetic imperfections may be visible to the customer under varying display conditions and can appear as bright, dim, or dark spots. *This issue is common across all vendors supplying TFT displays in their products and is not specific to the HP OmniBook display.*

HP OmniBook TFT displays meet or exceed all TFT manufacturer's standards for cosmetic quality of TFT displays. HP does not warrant that the displays will be free of cosmetic imperfections. *TFT displays may have a small number of cosmetic imperfections and still conform to the display manufacturer's cosmetic quality specifications.*

Here are some guidelines to use in determining what action to take on customers' complaints of cosmetic imperfections in their TFT displays:

1. The unit should be viewed in the customer's normal operating condition.

This means if the customer uses the unit predominately in DOS, in Windows, or in some other application or combination of applications, that is where you should make the determination. Self test is not a normal operating condition and is not a sufficient tool to interpret display quality.

2. Use the table below to determine whether the display should be considered for replacement.

These are the only conditions in this guideline that may call for a replacement due to a defect in material or workmanship based on the HP Limited Warranty Statement.

3. If a display is considered for replacement, it should be clear to the customer that cosmetic variations on the replacement display may also exist, and may require the customer to use a work-around to obscure the cosmetic imperfection.
4. Customers with cosmetic-based complaints only, that do not conform to the above conditions and tests will not normally be considered for display replacement. It will be left to the judgment of the HP-responsible person working with the customer, to identify work-arounds that are reasonable and appropriate for the individual customer. Customers who must have a more perfect display solution should consider switching to an OmniBook with a DSTN display.

We expect over time that the industry will continue to improve in its ability to produce displays with fewer inherent cosmetic imperfections, and we will adjust our HP guidelines as the improvements are implemented.

Table 5-1. OmniBook 4100/4150 LCD Guidelines (TFT)

Type of Imperfection	Imperfections Not Allowed
IBM 14" TFT, XGA (OmniBook 4150†/4150B, "IBM74E", F1640-69008)	
Electrical Imperfections: Bright dots (a) Dark dots (a)	<ul style="list-style-type: none"> • 4 or more single bright dots (2 or more in central area: 4x3-inch, 100x75mm). • 8 or more single dark dots. • 3 or more double bright dots. • 4 or more double dark dots. • 9 or more total bright and dark dots. • 2 or more triple dark dots. • Any occurrence of 2 bright dots within 15 mm. • Any occurrence of 2 dark dots within 5 mm.
Mechanical Imperfections: Polarizer scratches (d) Polarizer dents, bubbles (e)	<ul style="list-style-type: none"> • 4 or more scratches 0-5 mm long and over 0.01 mm wide. • 4 or more dents or bubbles 0.3-0.4 mm avg. dia. • Any scratch over 5 mm long and 0.01 mm wide, or over 0.1 mm wide. • Any dent or bubble over 0.4 mm avg. dia.
IBM 14" TFT, XGA (OmniBook 4100/4150†, "IBM74", F1629-69012)	
Electrical Imperfections: Bright dots (a) Dark dots (a)	<ul style="list-style-type: none"> • 8 or more single bright dots. • 8 or more single dark dots. • 9 or more total bright and dark dots. • Any occurrence of double bright dots. • 3 or more double dark dots. • Any occurrence of triple bright dots (or triple dark dots). • Any occurrence of 2 bright or dark dots within 20 mm.
LG 14" TFT, XGA (OmniBook 4100/4150†)	
Electrical Imperfections: Bright dots (a) Dark dots (a)	<ul style="list-style-type: none"> • 7 or more single bright dots. • 7 or more single dark dots. • 3 or more double bright dots. • 3 or more double dark dots. • 11 or more total bright and dark dot imperfections. • Any occurrence of triple bright dots (or triple dark dots). • Any occurrence of 3 bright dots within 20 mm (or 3 dark dots).
Mechanical Imperfections: Spots (b) Lines (c) Polarizer scratches (d) Polarizer dents, bubbles (e)	<ul style="list-style-type: none"> • 6 or more spots 0.2-0.5 mm avg. dia. • 4 or more lines 0.3-3 mm long and over 0.07 mm wide. • 5 or more scratches 5-20 mm long and over 0.02 mm wide. • 9 or more dents or bubbles 0-0.5 mm avg. dia. • Any spot over 0.5 mm avg. dia. • Any line over 3 mm long and 0.07 mm wide, or over 0.1 mm wide. • Any scratch over 20 mm long and 0.02 mm wide, or over 0.05 mm wide. • Any dent or bubble over 0.5 mm avg. dia.

Type of Imperfection	Imperfections Not Allowed
CPT 14" TFT, XGA (OmniBook 4150B)	
Electrical Imperfections: Bright dots (a) Dark dots (a)	<ul style="list-style-type: none"> • 9 or more single bright dots. • 9 or more single dark dots. • 11 or more total bright and dark dots. • 3 or more occurrences of double bright dots. • 3 or more double dark dots. • Any occurrence of triple bright dots (or triple dark dots). • Any occurrence of 2 bright or dark dots within 15 mm.
Mechanical Imperfections: Lines (c)	<ul style="list-style-type: none"> • Any line visible from at least 14 inches (35 cm) away.
Hyundai 13" TFT, XGA (OmniBook 4150B)	
Electrical Imperfections: Bright dots (a) Dark dots (a)	<ul style="list-style-type: none"> • 6 or more single bright dots. • 8 or more single dark dots. • 3 or more double bright or dark dots. • Any occurrence of triple bright or dark dots. • 10 or more total bright or dark dot imperfections. • Any occurrence of 2 single/double bright dots within 15 mm. • Any occurrence of 2 single/double dark dots within 15 mm.
Mechanical Imperfections: Spots (b) Lines (c) Polarizer scratches (d) Polarizer dents, bubbles (e)	<ul style="list-style-type: none"> • 3 or more spots, dents, or bubbles 0.2-0.5 mm avg. dia. • 5 or more lines or scratches 0.3-1 mm long and over 0.03 mm wide. • Any spot, dent, or bubble over 0.5 mm avg. dia. • Any line or scratch over 1 mm long and 0.03 mm wide, or over 0.05 mm wide.

Type of Imperfection	Imperfections Not Allowed
Samsung 13" TFT, XGA (OmniBook 4100)	
Electrical Imperfections: Bright dots (a) Dark dots (a)	<ul style="list-style-type: none"> • 11 or more single bright dots. • 11 or more single dark dots. • 2 or more double bright dots. • 6 or more double or triple dark dots. • 21 or more total bright or dark dot imperfections. • Any occurrence of 2 single/double bright dots within 15 mm. • Any occurrence of 2 single/double/triple dark dots within 5 mm.
Mechanical Imperfections: Spots (b) Lines (c) Polarizer scratches (d) Polarizer dents, bubbles (e)	<ul style="list-style-type: none"> • 5 or more spots 0.1-0.5 mm avg. dia. • 5 or more lines 0.3-1 mm long and over 0.01 mm wide. • 4 or more scratches 0.3-10 mm long and over 0.01 mm wide. • 7 or more dents or bubbles 0-0.5 mm avg. dia. • Any spot over 0.5 mm avg. dia. • Any line over 1 mm long and 0.01 mm wide, or over 0.8 mm wide. • Any scratch over 10 mm long and 0.01 mm wide, or over 0.1 mm wide. • Any dent or bubble over 0.5 mm avg. dia.
Definitions of imperfections: a Bright or dark dot: A subpixel (red, green, or blue dot) that is stuck on or off. b Spot: A point on the display that appears dark or bright and does not change in size. Caused by foreign circular matter on the backlight. c Line: A line on the display that appears dark or light and does not change in size. Caused by contamination (lint, hair) behind the display. d Polarizer scratch: A light line that is visible on a darker background and does not change in size. e Polarizer dent or bubble: A light spot with a darker border that appears on a lighted display and does not change in size.	

Service Notes and Obsolete Parts

Service notes containing important repair information are issued periodically for the HP OmniBook 4100/4150. These notes are available online at the Reseller website—see page vi. The following table lists recent service notes. Much information from these notes is included in this edition of the service manual.

Table 5-2. Service Notes

Service Note	Subject	Action Category
4100-01	Pentium II Motherboard Part Numbers - Correction	Information only
4100-02	Drifting Mouse When Using Pointing Stick	Mutually agreeable time
4100-03	System Fails to Boot Up - Defective CPU Heatsink	Mutually agreeable time
4100-04	13" LCD Discoloration When Display Is Moved	On specified failure
4100-05	13" LCD Repair Procedure to Prevent Discoloration	Mutually agreeable time
4100-06	Error 0232: Extended RAM Failed	Information only
4100-07	14" LCD Repair Parts	Information only
4150-01	Battery-Charging and Docking Problems	On specified failure

Sometimes, service notes describe new repair parts that replace obsolete parts. Obsolete repair parts are summarized in the following table.

Table 5-3. Obsolete Repair Parts

Obsolete Part Number	New Part Number	Description	Service Notes/Comments
F1460-60946	F1460-60939	Case, top	New part includes touch pad.
F1460-60947	(none)	Assembly, touch-pad support	Included with new top case.
F1460-60948	(none)	Cable, touch-pad flex	Included with new top case.
F1460-60921	F1649-60901	Keyboard, US English	Obsolete keyboards are compatible with OmniBook 4100 and 4150†. Caution: Obsolete keyboards are <i>not</i> compatible with OmniBook 4150B.
F1460-60927	F1649-60906	Keyboard, French-Canadian	
F1462-60930	F1649-60902	Keyboard, International English	
F1462-60931	F1649-60909	Keyboard, French	
F1462-60932	F1649-60907	Keyboard, German	
F1462-60933	F1649-60908	Keyboard, Spanish	
F1462-60934	F1649-60915	Keyboard, Italian	
F1462-60935	F1649-60912	Keyboard, Swiss	
F1462-60936	F1649-60913	Keyboard, Swedish	
F1462-60937	F1649-60911	Keyboard, Norwegian	
F1462-60938	F1649-60905	Keyboard, UK English	
F1462-60939	F1649-60914	Keyboard, Danish	
F1462-60940	F1649-60910	Keyboard, Japanese	
F1466-80001	F1466-80002	Battery, lithium-ion	
F1620-60901	F1620-60902	Charger, battery (external)	

- 1. Product Information**
- 2. Removal and Replacement**
- 3. Troubleshooting and Diagnostics**
- 4. Replaceable Parts**
- 5. Reference Information**