

# SIXPAK PREMIUM

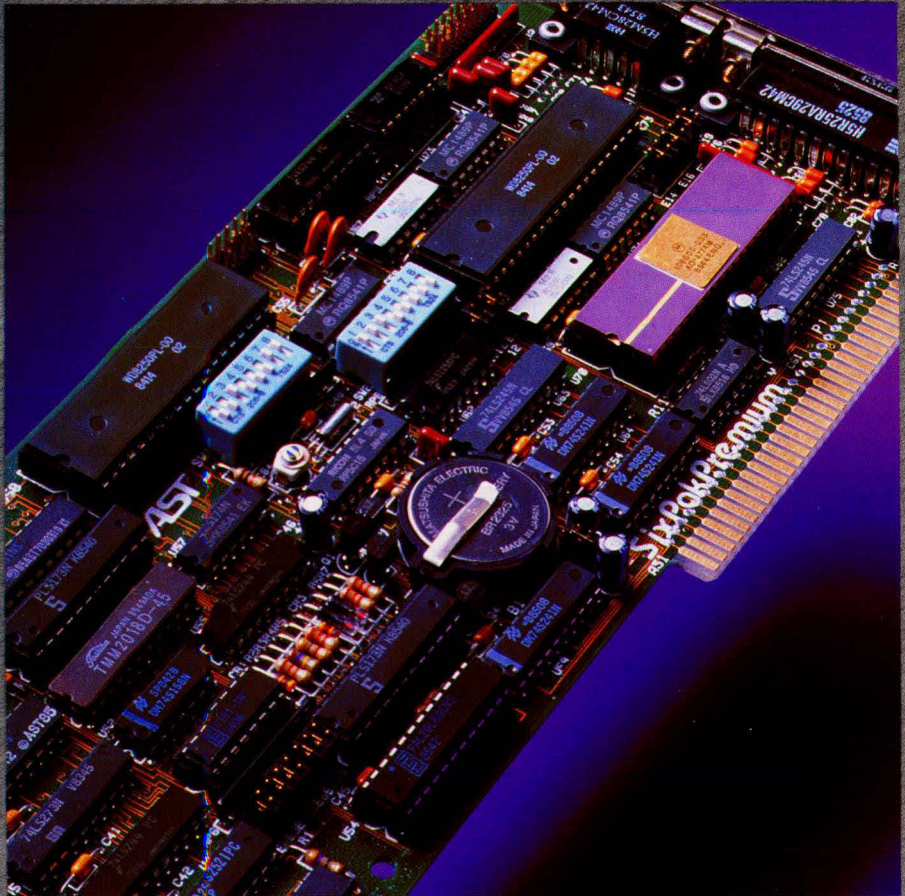

*Enhanced EMS Multi-  
function Board for  
the IBM PC, XT and  
Compatibles.*



*User's Manual*

AST Product

**SixPakPremium**

# Product Registration Form

MULTIFUNCTION

Name Last                      First		Company		Phone (                      )	
Street Address			City	State	Zip
Software Version (see diskette label)		Purchased from: <input type="checkbox"/> Retail _____ <input type="checkbox"/> Distributor <input type="checkbox"/> Mail <input type="checkbox"/> Sys. House/VAR _____ <input type="checkbox"/> Other _____ explain _____			
Purchase Date: (mm / yy)		No. of PCs at Site <input type="checkbox"/> <25 <input type="checkbox"/> 50-100 <input type="checkbox"/> >500 <input type="checkbox"/> 25-50 <input type="checkbox"/> 100-500			
Personal Computer Used IBM: <input type="checkbox"/> PC <input type="checkbox"/> XT <input type="checkbox"/> AT Other _____ <input type="checkbox"/> Other _____ mfg _____ model _____		No. of Employees at Site <input type="checkbox"/> <50 <input type="checkbox"/> 100-500 <input type="checkbox"/> >1000 <input type="checkbox"/> 50-100 <input type="checkbox"/> 500-1000			

In order to help us meet your needs, please complete as applicable:

1. When was this product purchased?

- Same time as the PC
- After PC purchase

2. What new product(s) or feature(s) would you like to see from AST?

\_\_\_\_\_

\_\_\_\_\_

\_\_\_\_\_

### System Configuration

- Multifunction/Memory \_\_\_\_\_
- Manufacturer \_\_\_\_\_
- Graphics  Color \_\_\_\_\_
- Manufacturer \_\_\_\_\_
- Data Communications \_\_\_\_\_
- Manufacturer \_\_\_\_\_
- Network Card \_\_\_\_\_
- Manufacturer \_\_\_\_\_
- Modem Baud Rate \_\_\_\_\_
- Manufacturer \_\_\_\_\_
- Hard Disk MBS \_\_\_\_\_
- Manufacturer \_\_\_\_\_

Please complete and return this card within (10) days of purchase. All AST board-level products are warranted for two years from date of purchase. If you encounter a problem with an AST product that is under warranty, you should call AST to receive a Return Authorization Number prior to returning the product to service.



NO POSTAGE  
NECESSARY  
IF MAILED  
IN THE  
UNITED STATES

**BUSINESS REPLY CARD**

FIRST CLASS

PERMIT NO. 7379

IRVINE, CA

POSTAGE WILL BE PAID BY ADDRESSEE

**AST Research, Inc.**  
Attn: Product Marketing  
2121 Alton Avenue  
Irvine, California 92714

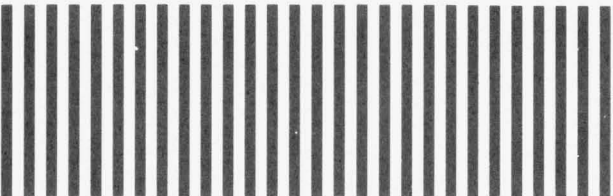

## FCC WARNING

This equipment has been certified to comply with the limits for a Class B computing device, pursuant to Subpart J of Part 15 of FCC Rules. Only peripherals (computer input/output devices, terminals, printers, etc.) certified to comply with the Class B limits may be attached to a computer that complies with Class B limits. Operation with non-certified peripherals is likely to result in interference to radio and TV reception. When connecting to a peripheral device, a shielded I/O cable is required to ensure compliance with FCC Rules.

### Instructions to User

This equipment generates and uses radio frequency energy and if not installed and used properly, that is, in strict accordance with the manufacturer's instructions, may cause interference to radio and television reception. It has been type tested and found to comply with the limits for a Class B computing device in accordance with the specifications in Subpart J of Part 15 of FCC Rules, which are designed to provide reasonable protection against such interference in a residential installation. However, there is no guarantee that interference will not occur in a particular installation. If this equipment does cause interference to radio or television reception, which can be determined by turning the equipment off and on, the user is encouraged to try to correct the interference by one or more of the following measures:

- Reorient the receiving antenna.
- Relocate the computer with respect to the receiver.
- Move the computer away from the receiver.
- Plug the computer into a different outlet so that computer and receiver are on different branch circuits.
- Ensure that board slot covers are in place when no board is installed.
- Ensure that all brackets are fastened securely to the PC chassis.

- Ensure that all brackets are fastened securely to the PC chassis

If necessary, the user should consult the dealer or and experienced radio/television technician for additional suggestions. The user may find the following booklet prepared by the Federal Communications Commission (FCC) helpful: "How to Identify and Resolve Radio-TV Interference Problems." This booklet is available from the U.S. Government Printing Office, Washington, DC 20402. Stock No. 004-000-00345-4.

**SixPakPremium  
Expanded  
Memory/Multifunction Card  
for the  
IBM Personal Computer,  
PC-XT, and  
Other IBM-Compatible Machines**

User's Manual

000334-001 C

July 1986

AST RESEARCH, INC.

Irvine, California

(714) 863-1333

Third Edition (July 1986)

SixPakPremium, Premium-Pak, Split Memory Addressing, *RAMpage!*, fASTdisk, SuperPak, SuperSpool, and SuperDrive are trademarks of AST Research, Inc. IBM is a registered trademark of International Business Machines Corporation. Symphony and Lotus 1-2-3 are trademarks of Lotus Development Corporation. Hercules is a trademark of Hercules Computer Technology.

Changes are periodically made to the information contained in this manual; these changes will be incorporated into new editions.

In view of demonstrated product reliability and comprehensive warranty policies, AST Research, Inc. does not normally provide schematics or material lists. AST recognizes that some customers with a large installed base of AST products want supportive documentation for their own service organizations. In such cases, customers should contact AST Research corporate offices to consider an appropriate nondisclosure agreement to obtain this documentation.

A Product Comment Form is provided at the back of this publication. If this form has been removed, please address your comments to: AST Research, Inc., Attn: Product Marketing, 2121 Alton Ave., Irvine, CA 92714. AST Research may use or distribute any of the information you supply in any form it deems appropriate without incurring any obligations whatsoever.

Copyright ©1986 AST Research, Inc. All rights are reserved, including those to reproduce this book or parts thereof in any form without permission in writing from AST Research, Inc.

#### **WARNING**

This manual and software are both protected by United States Copyright law (Title 17 United States Code). Unauthorized reproduction and/or sales may result in imprisonment of up to one year and fines of up to \$10,000 (17 USC 506). Copyright infringers may be subject to civil liability.

# TABLE OF CONTENTS

<b>SECTION 1. INTRODUCTION</b> .....	1-1
1.1 Checklist .....	1-3
1.2 Standard Features .....	1-3
1.3 System Requirements .....	1-6
1.4 How to Use this Manual .....	1-7
1.4.1 Format Notation .....	1-7
1.4.2 Related Documentation .....	1-7
1.4.3 Manual Outline .....	1-8
<b>SECTION 2. QUICK REFERENCE</b> .....	2-1
<b>SECTION 3. HARDWARE INSTALLATION AND CONFIGURATION</b> .....	3-1
3.1 Factory Configuration .....	3-2
3.2 Installing Premium-Pak .....	3-4
3.3 PC Setup .....	3-7
3.4 Installing SixPakPremium in Your PC .....	3-12
3.5 Testing the New Installation .....	3-16
3.6 Changing the Standard Configuration .....	3-16
3.6.1 Starting Memory Address .....	3-17
3.6.2 Parity Checking .....	3-18
3.6.3 SixPakPremium Conventional Memory Size .....	3-18
3.6.4 Base I/O Address .....	3-20
3.6.5 Serial Port (COM1/COM2) .....	3-21
3.6.6 Serial Port Inputs .....	3-22
3.6.7 Parallel Port .....	3-23
3.6.8 Game Port .....	3-24
3.6.9 Clock-Calendar .....	3-24
3.6.10 Dual Page Mode .....	3-25



# TABLE OF CONTENTS

(Continued)

<b>SECTION 4. SOFTWARE INSTALLATION &amp; CONFIGURATION</b> .....	4-1
4.1 Using INSTALL .....	4-2
4.2 Running the INSTALL Program .....	4-3
4.2.1 Installing FASTdisk .....	4-8
4.2.2 Installing SuperDrive .....	4-10
4.2.3 Installing the AST Expanded Memory Manager .....	4-13
4.2.4 Installing the Clock .....	4-14
4.2.5 Installing SuperSpool .....	4-14
4.2.6 Saving the Installation .....	4-17
<b>SECTION 5. CLOCK-CALENDAR</b> .....	5-1
5.1 Configuring the Clock-Calendar .....	5-1
5.1.1 Disabling the Clock-Calendar .....	5-2
5.2 Preparing Your PC Boot Disk .....	5-2
5.3 Setting the TIME and DATE .....	5-4
5.4 The Clock-Calendar Battery .....	5-7
5.5 Technical Information .....	5-9
<b>SECTION 6. SERIAL PORT</b> .....	6-1
6.1 Configuring the Serial Ports .....	6-1
6.1.1 Installing Multiple Serial Ports in a PC .....	6-3
6.1.2 Configuring the RS-232C Interface Lines .....	6-3
6.1.3 Disabling the Serial Port .....	6-5
6.2 Programming the Serial Port .....	6-5
6.3 Serial I/O Address Assignments and Pinouts .....	6-7
6.4 Serial Port Diagnostic Testing .....	6-10
6.5 Adding the Second Serial Port .....	6-11

# TABLE OF CONTENTS

(Continued)

<b>SECTION 7. PARALLEL PRINTER PORT</b> .....	7-1
7.1 Configuring the Parallel Port .....	7-1
7.1.1 Installing Multiple Parallel Ports in a PC .....	7-3
7.1.2 Display Adapters with Built-in Parallel Ports ..	7-3
7.1.3 Disabling the Parallel Port .....	7-3
7.2 Programming the Parallel Port .....	7-3
7.3 Parallel Port I/O Addresses and Pinouts .....	7-4
7.4 Parallel Port Diagnostic Testing .....	7-5
7.5 Interrupt-Driven Parallel Printer Software .....	7-7
<b>SECTION 8. GAME PORT</b> .....	8-1
8.1 Configuring the Game Port .....	8-1
8.2 Software Compatibility .....	8-2
8.3 Game Port Technical Information .....	8-2
8.3.1 Game Port I/O Address Assignment .....	8-2
8.3.2 Game Port Pinouts .....	8-3
8.4 Game Port Diagnostic Testing .....	8-4
8.5 Adding the Game Port to Your SixPakPremium .....	8-4
<b>SECTION 9. MEMORY CONFIGURATION</b> .....	9-1
<b>APPENDIX A. SERIAL INTERFACES</b> .....	A-1
A.1 RS-232C Interface Standard .....	A-2
A.2 Interfacing DTE to DCE .....	A-3
A.3 Interfacing DTE to DTE ("Null Modem") .....	A-6
A.4 Design Aids .....	A-10

# TABLE OF CONTENTS

(Continued)

<b>APPENDIX B. SWITCHING BETWEEN PARALLEL PRINTER PORTS</b> .....	B-1
B.1 Switching Between LPT1 and LPT2 .....	B-2
B.2 Restoring LPT1 to LPT1 and LPT2 to LPT2 .....	B-2
B.3 Switching Between LPT1 and LPT3 .....	B-3
B.4 Restoring LPT1 to LPT1 and LPT3 to LPT3 .....	B-3
<b>APPENDIX C. HOW SIXPAKPREMIUM WORKS</b> .....	C-1
C.1 Memory Paging .....	C-1
C.2 Expanded Memory Manager — REMM.SYS .....	C-3
C.3 Extended Memory Emulator — REX.SYS .....	C-3
C.4 Modifying REMM and REX .....	C-4
C.4.1 DEVICE = REMM.SYS Parameters .....	C-4
C.4.2 DEVICE = REX.SYS Parameters .....	C-8
C.4.3 Modifying CONFIG.SYS for FASTdisk .....	C-8
<b>APPENDIX D. TROUBLESHOOTING</b> .....	D-1
D.1 Solving Common Problems .....	D-1
D.2 Product Repair Procedure .....	D-4

## Figures

Figure 2-1. SixPakPremium Board Layout (Default Configuration) .....	2-3
Figure 2-2. Most Common PC System Board Switch Settings .....	2-4
Figure 3-1. SixPakPremium Installation Overview .....	3-1
Figure 3-2. SixPakPremium Standard Configuration .....	3-2
Figure 3-3. Premium-Pak Board Layout .....	3-5

# TABLE OF CONTENTS

(Continued)

Figure 3-4.	Installing Standoffs .....	3-6
Figure 3-5.	Installed Premium-Pak .....	3-7
Figure 3-6.	Removing the PC Cover .....	3-8
Figure 3-7.	IBM PC System Board Switch Settings .....	3-10
Figure 3-8.	IBM PC-XT System Board Switch Settings ..	3-11
Figure 3-9.	Connecting SixPakPremium Cables .....	3-13
Figure 3-10.	Installing the Plastic Card Guide .....	3-14
Figure 3-11.	Installing the SixPakPremium Board .....	3-15
Figure 3-12.	Starting Memory Address .....	3-17
Figure 3-13.	Parity Error Checking .....	3-18
Figure 3-14.	SixPakPremium Conventional Memory Size ..	3-19
Figure 3-15.	SixPakPremium Base I/O Address Settings ..	3-20
Figure 3-16.	Serial Port COM Assignments .....	3-21
Figure 3-17.	Serial Port Input Configuration .....	3-22
Figure 3-18.	Parallel Port Configuration .....	3-23
Figure 3-19.	Game Port Configuration .....	3-24
Figure 3-20.	Clock-Calendar Configuration .....	3-24
Figure 3-21.	Dual Page Mode Configuration .....	3-25
Figure 4-1.	Initial INSTALL Screen .....	4-4
Figure 4-2.	Main INSTALL Menu .....	4-7
Figure 4-3.	INSTALL with fASTdisk Edit Box .....	4-9
Figure 4-4.	INSTALL with SuperDrive Edit Box .....	4-12
Figure 4-5.	INSTALL with SuperSpool Edit Box .....	4-16
Figure 5-1.	Clock-Calendar Factory Configuration .....	5-2
Figure 5-2.	Removing the SixPakPremium Clock-Calendar Battery .....	5-8
Figure 6-1.	Serial Port Configuration .....	6-2
Figure 6-2.	Creating a "Forced True" State .....	6-4
Figure 6-3.	SixPakPremium Serial Port Pinouts .....	6-8
Figure 6-4.	DB9-to-DB25 Adapter Cable Pinouts .....	6-9
Figure 6-5.	Typical DB9-to-DB25 Cable Application .....	6-9
Figure 6-6.	Serial Port Loopback Plug Configuration ...	6-10
Figure 6-7.	Installing the Second Serial Port Chips .....	6-12

# TABLE OF CONTENTS

(Continued)

Figure 7-1.	Parallel Port Configuration .....	7-2
Figure 7-2.	Parallel Port Loopback Plug Configuration ...	7-6
Figure 7-3.	IRQ7 Enabled.....	7-7
Figure 8-1.	Game Port Port Pinout .....	8-2
Figure 8-2.	Installing the Game Port Chips .....	8-6
Figure 9-1.	SixPakPremium and Premium-Pak Memory Configuration .....	9-2
Figure A-1.	DTE-to-DCE Interface .....	A-5
Figure A-2.	Example #1: Null Modem (DTE-to-DTE) Interface .....	A-7
Figure A-3.	Example #2: Null Modem Interface .....	A-8
Figure A-4.	Example #3: Null Modem Interface .....	A-9
Figure A-5.	Serial Interface Form.....	A-11
Figure C-1.	Paging Technique .....	C-2

## Tables

Table 2-1.	Default SixPakPremium Configuration .....	2-2
Table 3-1.	SixPakPremium Standard Configuration .....	3-3
Table 5-1.	Compatible Clock-Calendar Batteries.....	5-7
Table 6-1.	Serial Port I/O Addresses and IRQs.....	6-7
Table 7-1.	Parallel Port I/O Addresses .....	7-4
Table 7-2.	Parallel Port Pinouts.....	7-5
Table 8-1.	SixPakPremium Game Port Pinouts .....	7-3

## SECTION 1

### INTRODUCTION

The AST SixPakPremium™ and the optional Premium-Pak™ combine to form a flexible and powerful multifunction enhancement that represents a new generation of products to expand your personal computer's (PC's) available memory and input/output (I/O) capabilities. SixPakPremium offers:

- *Conventional memory* upgradeable to the maximum 640 kilobytes (KB) of addressable user memory recognized by the IBM PC and compatibles.
- *Expanded memory* beyond the conventional 640-KB limit. SixPakPremium expanded memory supports expanded memory specification (EMS) software, including Lotus 1-2-3 Release 2™ and Symphony 1.1™.

SixPakPremium also supports the enhanced expanded memory specification (EEMS), providing superior performance with software written to support it, including the DESQview™ multitasking/windowing environment.

AST expanded memory software allows your PC to access up to 8 megabytes (MB) of memory (using four 2-MB AST expanded memory boards, including SixPakPremium and *RAMpage!*™), while maintaining DOS compatibility.

To ensure compatibility, use only AST expanded memory products (such as *RAMpage!*) in addition to SixPakPremium.

- SixPakPremium is fully compatible with the Lotus/Intel/Microsoft (LIM) version 3.2 Expanded Memory Specification (EMS). However, AST's EEMS offers a more flexible paging scheme that maximizes software performance and exceeds the capabilities of the LIM EMS.
- I/O capabilities, including an RS-232C serial asynchronous communications port (an optional second serial port is also available), a parallel port, and an optional game port.

Your SixPakPremium comes with these valuable SuperPak™ utility programs:

- *RAMpage!* Expanded Memory Manager (REMM) and *RAMpage!* Extended Memory Emulator (REX) software.
- *fASTdisk*, a program that simulates fixed disks in random access memory (RAM). A fASTdisk can be as large as total PC memory, and allows you to store and retrieve data and programs at RAM speeds.
- *SuperDrive*™, a floppy disk emulation program that allows you to use part of your memory as a superfast "electronic disk drive".
- *SuperSpool*™, an intelligent print spooler that allows you to output files to a printer while freeing your PC for other tasks.
- *ASTCLOCK*, the real-time clock-calendar program that frees you from having to re-enter the time and date every time you boot your PC.
- *INSTALL*, a new program that allows easy installation of the fASTdisk, SuperDrive, SuperSpool, RAMpage, and ASTCLOCK programs.

Your SuperPak diskette may also include other software (which may pertain to other AST products). The READ.ME file on your SuperPak diskette describes the programs included in your SuperPak software.

## 1.1 Checklist

Before you get started, check that your SixPakPremium package includes the following:

- SixPakPremium circuit board.
- SuperPak diskette (version 6.0 or later)
- *SixPakPremium User's Manual*.
- *SuperPak User's Manual*.
- Plastic card guide.
- Premium-Pak piggyback board and four nylon standoffs (if the Premium-Pak option is included).
- Second serial port ribbon cable and bracket (if the second serial port option is included).
- Game port ribbon cable and bracket (if the game port option is included).

## 1.2 Standard Features

Each SixPakPremium product features:

- Up to 640 KB of conventional memory — the normal PC RAM limit.
- Up to 2 MB of expanded memory beyond the normal PC user memory limit of 640 KB. You can install as many as four 2-MB AST expanded memory boards in a single PC, increasing the available memory by 8 MB. A typical configuration might be one SixPakPremium with Premium-Pak installed (to provide 2 MB plus I/O capabilities) with three *RAMpage!* boards (to provide 6 MB of memory only).



- Split Memory Addressing™, which allows SixPakPremium to round out PC (or compatible) conventional memory to its 640-KB limit, then allocate remaining SixPakPremium memory as expanded memory.
- Memory that is user-upgradeable in 256-KB increments, using 256-KB RAM chips.
- An RS-232C serial port. You can use the serial port to interface to a modem, serial printer, remote display terminal, or other serial device. You can also use the serial port as an asynchronous communications port to another computer or peripheral operating under separate asynchronous communications software control.
- A parallel printer port. You can use the parallel port to connect a parallel printer or plotter to the PC.
- A real-time clock-calendar with battery backup. Battery backup frees you from having to re-enter the time and date every time you start your system. The battery power is only used when your system is turned off.

These options are available for your SixPakPremium:

- Memory expansion is available in 256-KB increments up to 1024 KB (1 MB) on the SixPakPremium board, plus additional memory of up to 1 MB on the Premium-Pak piggyback board.
- A second RS-232C serial communications port (AST Model No. SPKP-000S) on the SixPakPremium board that can interface to a modem, serial printer, remote display terminal, or other serial device.
- A game port (AST Model No. SPKP-000G) that can be used with one or two IBM-compatible joysticks.

You can purchase these options onboard or install them at a later date. Upgrade kits are available from your dealer.

SixPakPremium software offers the following features:

- The *RAMpage!* Expanded Memory Manager (REMM) software driver, which works with applications software such as the DESQview operating environment to provide expanded memory for data and programs, and Lotus 1-2-3 Release 2 to provide expanded memory for data.

#### NOTE

To use SixPakPremium expanded memory, the REMM.SYS program *must* be installed on your boot disk. The SuperPak INSTALL program performs this installation automatically.

- The *RAMpage!* Extended Memory Emulator (REX) module, which works with REMM software to allow utilities (such as AST Research's fASTdisk, SuperDrive, SuperSpool, and IBM's VDISK utility) to operate from expanded memory.
- AST Research's RAM disk and print spooler software, including fASTdisk, SuperDrive, and SuperSpool.
- Full compatibility with the Lotus/Intel/Microsoft (LIM) version 3.2 Expanded Memory Specification (EMS). SixPakPremium is fully compatible with LIM EMS software.
- AST's enhanced EMS (EEMS) exceeds the LIM EMS and is a superset of that standard. EEMS's more flexible paging scheme allows maximum software performance, including fast access to multiple programs and multitasking under DESQview.

### NOTE

Multitasking under DESQview is *considerably* enhanced when SixPakPremium memory is allocated below 640 KB (the more SixPakPremium memory below 640 KB, the greater the performance advantages). See your *DESQview User's Manual*.

The EEMS memory manager identifies all open 16-KB memory pages above 640 KB as windows for accessing expanded memory. EEMS allows up to 64 pages at one time to be allocated for swapping (EMS supports 4). To further enhance performance, EEMS also supports direct memory swapping between expanded and SixPakPremium conventional memory.

### NOTE

You must use a version 6.0 (or later) SuperPak diskette with the SixPakPremium. For information on the SuperPak utilities, see your *SuperPak User's Manual*.

## 1.3 System Requirements

The minimum hardware requirements for operation with SixPakPremium are an IBM PC or PC-XT (or compatible) with one floppy diskette drive and an unused full-length expansion slot.

SixPakPremium software is compatible with DOS 2.0 or later, or an MS-DOS equivalent.

## 1.4 How To Use This Manual

This section provides an outline of the format notation used throughout the manual, a list of related documentation, and an outline of the manual.

### 1.4.1 Format Notation

The following format notation is used in this manual:

- *Boldface* is used to indicate keyboard entries the user must make.
- *Angle brackets (< >)* tell you to press a key. For example, <**Esc**> instructs you to press the "Esc" key. You do not have to press <**Enter**> unless you are specifically instructed to do so.
- System prompts and messages are indicated in color.

### 1.4.2 Related Documentation

This manual assumes some familiarity with the PC-DOS operating system and the IBM PC or PC-XT hardware. You may find it useful to have available the following documents for reference:

- *IBM PC Guide to Operations*
- *IBM PC Technical Reference Manual*
- *IBM Disk Operating System (DOS) Manual.*
- *AST Research SuperPak User's Manual.*
- *Specification for an Expanded Memory Device Interface Product Version 1.0, Copyright 1985 AST Research, 2121 Alton Avenue, Irvine, CA 92714.*

- *Specification for the Enhanced Expanded Memory Product Software Interface Version 3.2*, Copyright 1986 AST Research, 2121 Alton Avenue, Irvine, CA 92714.
- *Expanded Memory Device Interface Specification*, Copyright 1985 Lotus Development Corporation, 161 First Street, Cambridge, MA 02142.

For technical and programming information on the SixPakPremium clock-calendar chip (RICOH RP5C15), refer to the RICOH *RP5C01/RP5C15 Application Manual*.

### **1.4.3 Manual Outline**

The following outline describes this manual.

#### *SECTION 1: INTRODUCTION*

Describes the features of the SixPakPremium product, and provides information on system requirements, format notation, and related documentation.

#### *SECTION 2: QUICK INSTALLATION REFERENCE*

Provides a quick reference guide to the most common switch settings for SixPakPremium and PC system board.

#### *SECTION 3: HARDWARE CONFIGURATION AND INSTALLATION*

Tells you how to configure your SixPakPremium board and install it in your PC.

#### *SECTION 4: SOFTWARE CONFIGURATION AND INSTALLATION*

Tells you how to use the INSTALL program to configure and install the software that comes with your SixPakPremium.

#### *SECTION 5: CLOCK-CALENDAR*

Tells you how to use the clock-calendar.

#### *SECTION 6: SERIAL PORT*

Gives a detailed description of the serial port(s).

**SECTION 7: PARALLEL PRINTER PORT**

Gives a detailed description of the parallel printer port.

**SECTION 8: GAME PORT**

Provides information on the optional game port.

**SECTION 9: MEMORY CONFIGURATION**

Tells you how to add or remove SixPakPremium and/or Premium-Pak memory.

**APPENDIX A: SERIAL INTERFACES**

Gives general serial port wiring information.

**APPENDIX B: SWITCHING BETWEEN PARALLEL PRINTER PORTS**

Provides a program that routes printer output from one parallel port to another.

**APPENDIX C: HOW SIXPAKPREMIUM WORKS**

Gives a brief overview of how SixPakPremium works, including the concept of memory paging, descriptions of the REMM and REX software modules, and how to modify them.

**APPENDIX D: TROUBLESHOOTING**

Provides instructions for obtaining repair service on your AST Research product.

(This page intentionally left blank)

## SECTION 2

### QUICK REFERENCE

This section provides a quick reference guide to the most common switch settings for SixPakPremium and the IBM PC system board. These settings are appropriate *only* if:

- You are installing SixPakPremium in a PC that already has exactly 256 kilobytes (KB) of conventional memory installed.
- Your PC switches are set to recognize three “floppy” disk drives (for example, floppy drives A: and B:, and SuperDrive C:).
- You install SixPakPremium in its factory configuration (summarized in Table 2-1).
- None of the following are already installed in your PC: a serial port, parallel port (other than the built-in parallel port in a display adapter), or another expanded memory board.

For a more detailed description of how to configure and install SixPakPremium into your PC, see Section 3.



**Table 2-1. Default SixPakPremium Configuration.**

Parameter	Default Setting
Starting memory address	256 KB: 256 KB of memory already installed in your PC (SW1-1 through 4).
Dual page mode	Enabled: Allows two sets of mapping registers — ensures proper multitasking operation (SW1-7).
Parity checking	Enabled: Ensures reliable memory error checking (SW1-8).
Base I/O address	0218: Hexadecimal address SixPakPremium uses to communicate with your PC so it can make use of expanded memory (SW2-1 through 4).
SixPakPremium conventional memory size	Up to 256 KB: The maximum amount of SixPakPremium memory that is allocated in the 0- to 640-KB memory area (SW2-7 through 8). After rounding out memory to 640 KB, all remaining SixPakPremium memory is allocated as expanded (paged) memory.
First serial port	COM1 enabled (jumper E3).
COM1 using IRQ4	Enabled: First serial port COM1 uses IRQ4 (jumper E20).
Second (optional) serial port	COM2: enabled only if second serial port is installed (jumper E4). Disabled if second serial port is not installed.
COM2 using IRQ3	Enabled only if second serial port COM2 is installed. Disabled if second port not installed (jumper E18).
Serial port inputs	Serial inputs driven by connected device (allows reconfiguration in case your PC is attached to a device that requires inputs forced true — your serial device documentation will tell you if you need to change this parameter). (First port: jumpers E21 through E26; second port: jumpers E10 through E15.)
Parallel port	LPT1: Responds as LPT2 if a display adapter with a built-in parallel port is installed in your PC (jumper E6).
LPT1 using IRQ7	Enabled: Parallel port uses IRQ7 (jumper E17).
Game port (optional)	Enabled only if game port installed (jumper E8). Disabled if game port not installed.
Clock-calendar	Enabled (jumper E9).

Figure 2-1 shows the standard SixPakPremium configuration.

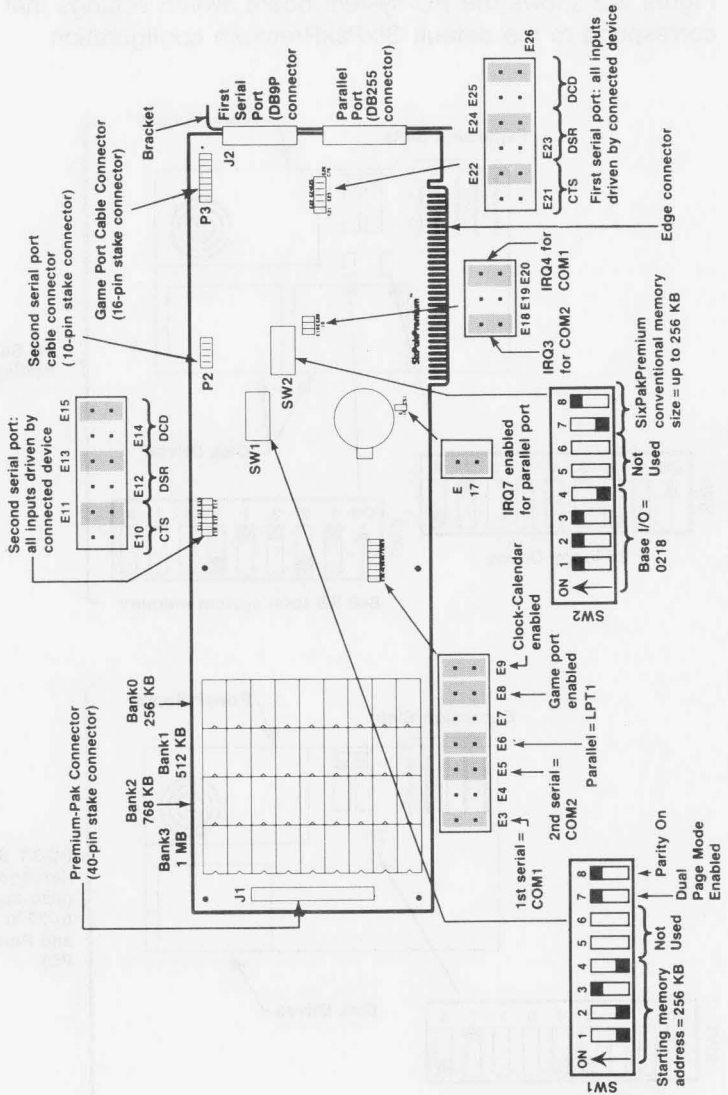

Figure 2-1. SixPakPremium Board Layout (Default Configuration).

Figure 2-2 shows the PC system board switch settings that correspond to the default SixPakPremium configuration.

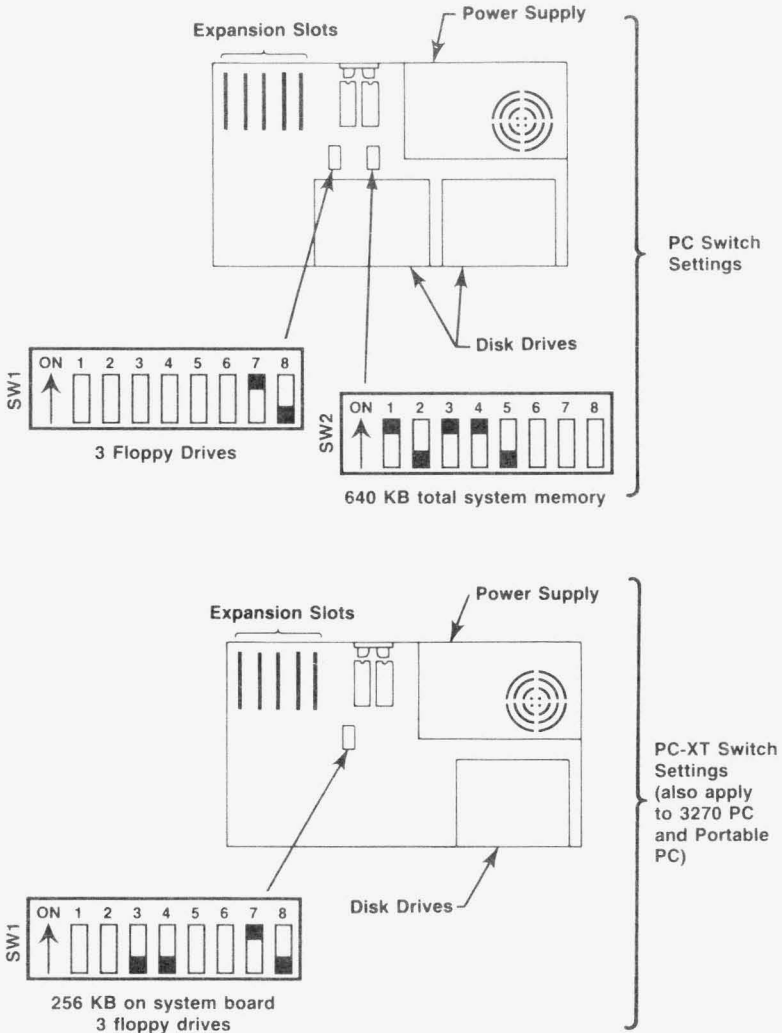
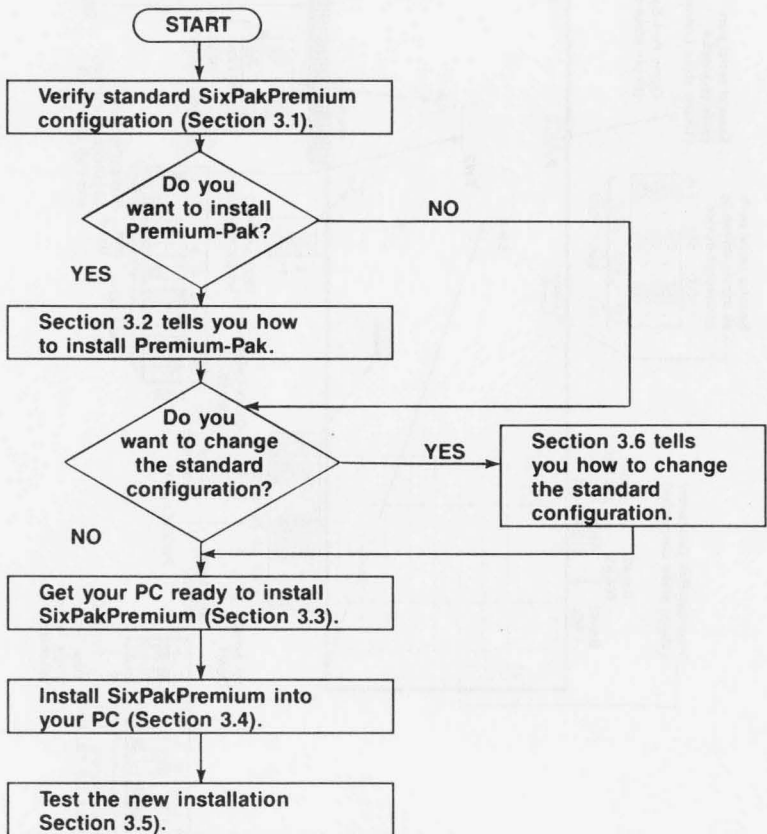

Figure 2-2. Most Common PC System Board Switch Settings.

## SECTION 3

# HARDWARE CONFIGURATION AND INSTALLATION

This section tells you how to configure your SixPakPremium and install it in your PC. Figure 3-1 summarizes the SixPakPremium installation procedure.



**Figure 3-1. SixPakPremium Installation Overview.**

### 3.1 Factory Configuration

Figure 3-2 shows SixPakPremium in its standard configuration. If you want to change the default configuration, see Section 3.6.

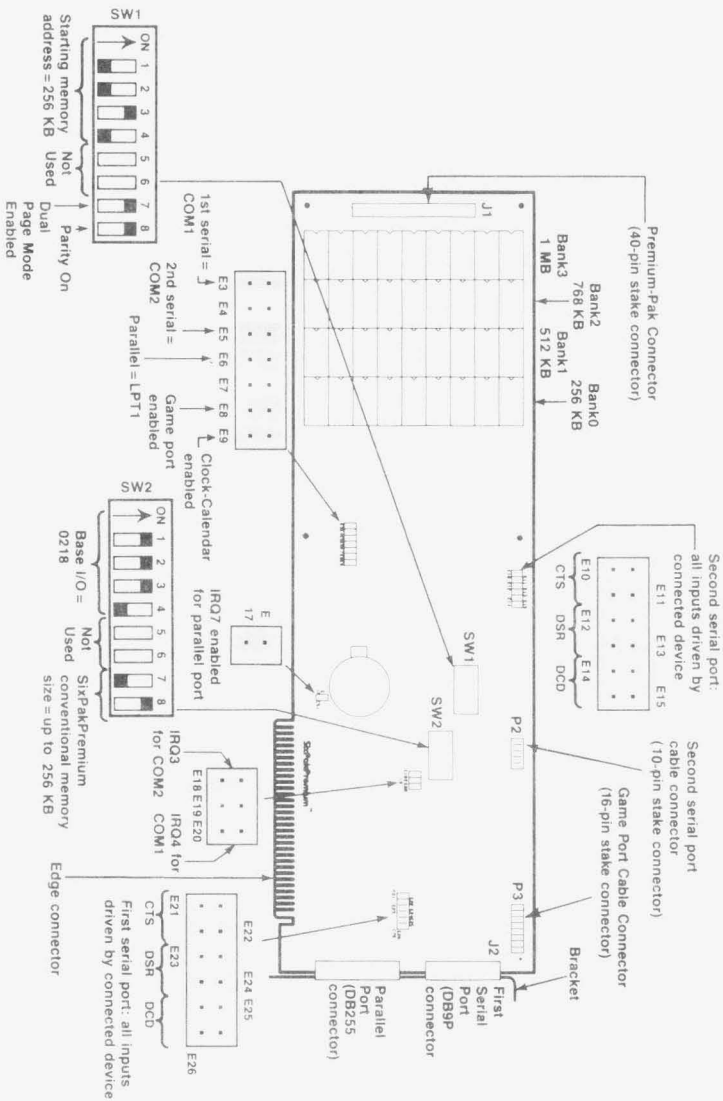

Figure 3-2. SixPakPremium Standard Configuration.

Table 3-1 summarizes the SixPakPremium's standard configuration.

**Table 3-1. SixPakPremium Standard Configuration.**

Parameter	Standard Configuration	Comments
Starting Memory Address	256 KB (SW1-1 OFF SW1-2 OFF SW1-3 ON SW1-4 OFF)	Do not change this setting unless your PC has other than 256 kilobytes (KB) of conventional memory installed (see the note following this table).
Parity Checking	Enabled (SW1-8 ON)	Parity checking enables the most reliable memory operation.
SixPakPremium Conventional Memory Size	Up to 256 KB (SW2-7 OFF SW2-8 ON)	The maximum amount of SixPakPremium memory that is allocated in the 0- to 640-KB area. After rounding out memory to 640 KB, all remaining SixPakPremium memory is allocated as expanded (paged) memory.
Base I/O Address	0218-0219 (SW2-1 ON SW2-2 ON SW2-3 ON SW2-4 OFF)	Your PC uses the I/O address to communicate with SixPakPremium so it can make use of expanded memory. Do not change the base I/O address unless necessary to avoid conflict with another device in your PC (such as <i>RAMpage!</i> ).
Dual Page Mode	Enabled (SW1-7 ON)	Ensures proper multitasking operation.
Serial ports	First serial port is COM1, using IRQ4. (Shorting plugs at E3 and E20.) If installed, second serial port is COM2, using IRQ3. (Shorting plugs at E4 and E18.)	Can also configure first serial port as COM2 (IRQ3). Second serial port must be installed.
Serial port inputs	CTS, DSR, DCD driven by the connected device. (Shorting plugs at E22, E24, and E26 for first serial port, E11, E13, and E15 for second serial port.)	Can also configure any input to be "forced true" if the connected device does not drive that signal (your serial device documentation will tell you if you need to reconfigure the serial port inputs).
Parallel port	Configured as LPT1 using IRQ7 (Shorting at E6 and E17.)	Can also configure as LPT2 or disable IRQ7. Section 7 tells you how to change setting.
Game port (if installed).	Enabled if installed. Must disable if game port not installed. (Shorting plug at E8.)	Section 8 gives more detail.
Clock-calendar	Enabled. (Shorting plug at E9.)	Section 5 gives more detail.

### NOTE

Multiple application programs which together require a total of much more than 640 KB can be run at the same time under DESQview if your SixPakPremium starting address is *256 KB or lower*, and your SixPakPremium has enough memory installed. The more SixPakPremium memory that is allocated in the area below 640 KB, the greater the enhancement of DESQview's performance.

## 3.2 Installing Premium-Pak

This section tells you how to install Premium-Pak onto your SixPakPremium. If you are not installing Premium-Pak now, skip to Section 3.3.

Premium-Pak (Figure 3-3) is an optional piggyback board that adds up to 1 megabyte (MB) of random access memory (RAM) to SixPakPremium. All SixPakPremium memory banks must be fully populated before installing a Premium-Pak.

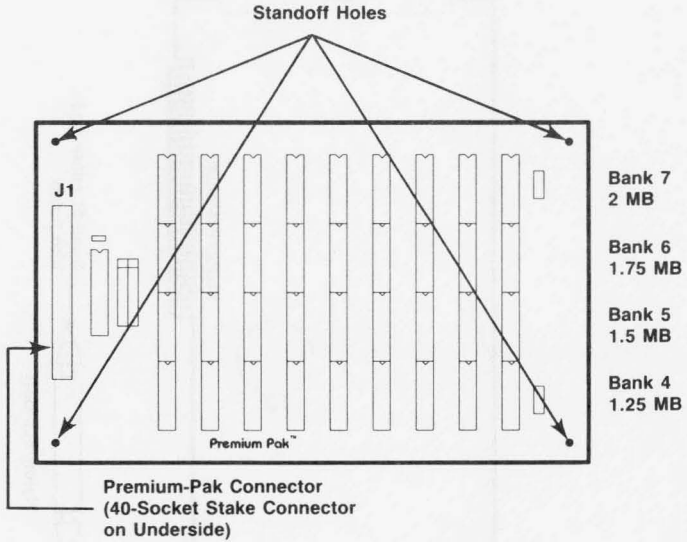

**Figure 3-3. Premium-Pak Board Layout.**

Follow this procedure to install Premium-Pak onto SixPakPremium:

**STEP 1**

*Install standoffs:* Locate the four nylon standoffs that come with Premium-Pak. Snap them into the standoff holes on SixPakPremium (Figure 3-4).



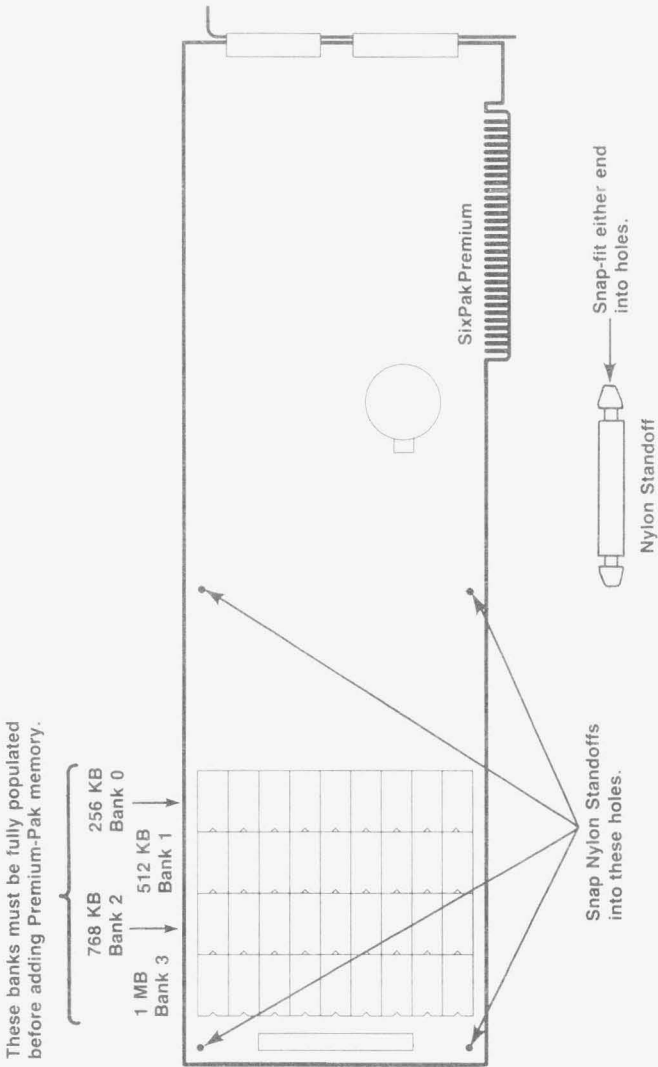
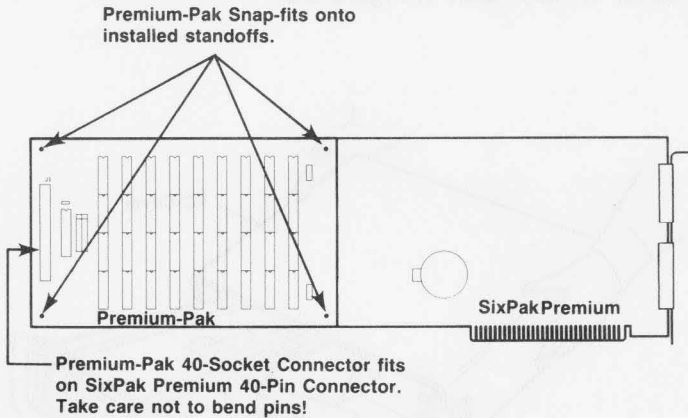

Figure 3-4. Installing Standoffs.

**STEP 2**

*Install Premium-Pak:* Fit the 40-socket Premium-Pak stake connector onto the 40-pin stake connector, taking care not to bend any pins. Align the Premium-Pak standoff holes over the installed standoffs. Snap-fit the board over the standoffs. Figure 3-5 shows Premium-Pak installed.



**Figure 3-5. Installed Premium-Pak.**

### 3.3 PC Setup

This section tells you how to set up your IBM PC or PC-XT before installing SixPakPremium.

#### CAUTION

Be sure that the power switch is off and the power cord is removed from the system unit. Turn off any other equipment connected to the computer. Installing any component while the power is on can permanently damage your computer and its components.

You will need a flathead screwdriver or nut driver to perform the following procedure.

### STEP 1

*Remove the PC cover:* Use a flathead screwdriver or nut driver to remove the cover mounting screws from your PC (see your PC's manual for the location of the cover mounting screws). Once you have removed the cover mounting screws, pull the PC cover off as shown in Figure 3-6.

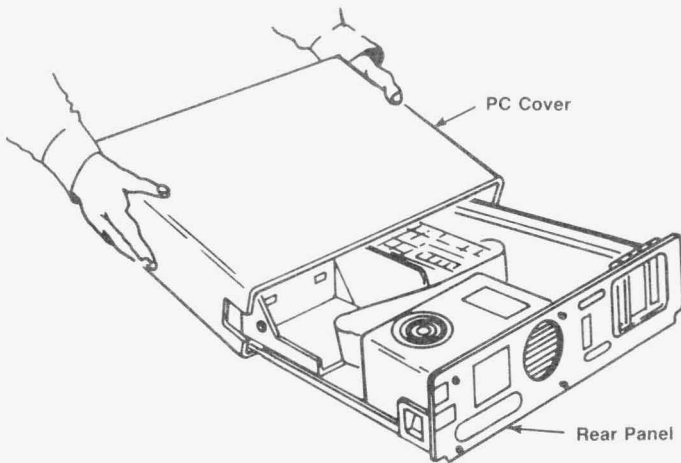

**Figure 3-6. Removing the PC Cover.**

### STEP 2

*Set system board switches:* Set the switches on the system board for the amount of conventional memory and number of disk drives (excluding fixed disk drives) installed in your PC, as shown in Figure 3-7 (for PCs) or Figure 3-8 (for PC-XTs). Also see STEP 3 below if you plan to use SuperDrive.

- *For PCs (not PC-XTs):* Set the PC system board for total conventional memory, including any SixPakPremium memory you plan to allocate as conventional memory.

Total conventional memory is the amount of memory on the PC system board plus the amount of SixPakPremium memory you will allocate as conventional memory. For most applications, this is 640 KB: 256 KB on the system board plus 384 KB contributed by SixPakPremium.

Set PC system board DIP switch SW2 to the total as shown in Figure 3-7. Remember that your IBM PC system board must be fully populated before you can include SixPakPremium memory in the total conventional memory.

- *For PC-XTs:* The system board switch in the PC-XT tells the computer only how much conventional memory is installed on the system board itself. Any additional conventional contributed by SixPakPremium will automatically be recognized. Verify that the system board switch is properly set as shown in Figure 3-8.

### STEP 3

*If you are installing SuperDrive:* SixPakPremium comes standard with the SuperDrive floppy disk drive simulation program. If you will be using SuperDrive, you must set the system board DIP switch SW1 at this time for the number of floppy drives (including SuperDrive) in your PC or PC-XT, as shown in Figure 3-7 (for PCs) or Figure 3-8 (for PC-XTs).

### NOTE

You do not need to set the PC system board switches for the number of fixed disk drives (or fASTdisk simulated fixed disk drives).

For further information on the SuperDrive program (or any of the other SuperPak programs), see your *SuperPak User's Manual*.

**IBM PC (64- and 256-KB System Board)**

*Number of Diskette Drives	SW1-7	SW1-8
1	ON	ON
2	OFF	ON
3	ON	OFF
4	OFF	OFF

\*Diskette drives include floppy drives and RAM drives (such as SuperDrive). Do not include fixed disks in this number.

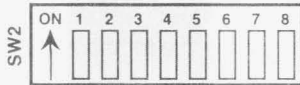
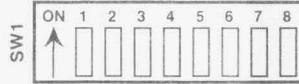

Total Memory	SW2-1	SW2-2	SW2-3	SW2-4	SW2-5
64 KB	ON	ON	ON	ON	ON
128 KB	ON	OFF	ON	ON	ON
192 KB	ON	ON	OFF	ON	ON
256 KB	ON	OFF	OFF	ON	ON
320 KB	ON	ON	ON	OFF	ON
384 KB	ON	OFF	ON	OFF	ON
448 KB	ON	ON	OFF	OFF	ON
512 KB	ON	OFF	OFF	OFF	ON
**576 KB	ON	ON	ON	ON	OFF
**640 KB	ON	OFF	ON	ON	OFF

\*\*256-KB system board only.

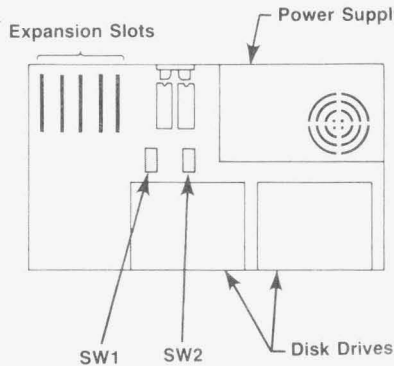

**Figure 3-7. IBM PC System Board Switch Settings.**

**IBM PC-XT (also Portable PC and 3270 PC)**

*Number of Diskette Drives	SW1-7	SW1-8
1	ON	ON
2	OFF	ON
3	ON	OFF
4	OFF	OFF

\*Diskette drives include floppy drives and RAM drives (such as SuperDrive). Do not include fixed disks in this number.

System Board Memory	SW1-3	SW1-4
128 KB	OFF	ON
192 KB	ON	OFF
256 KB	OFF	OFF

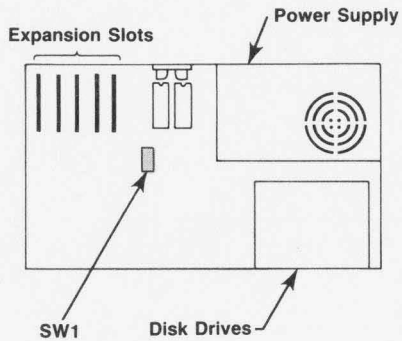
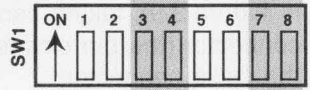

**Figure 3-8. IBM PC-XT System Board Switch Settings.**

## 3.4 Installing SixPakPremium in Your PC

### STEP 1

*Install SixPakPremium cables:* This is required only if you plan to use the second serial port and/or game port mounted on the supplied brackets. If not, skip to STEP 2.

Each cable comes with a bracket. Use the hardware supplied on the D-shell connectors to mount each connector on its bracket. Plug each connector onto SixPakPremium (as shown in Figure 3-9), taking care to align pin 1 on the cable connector (the pin closest to the cable stripe) with pin 1 on the stake connector.

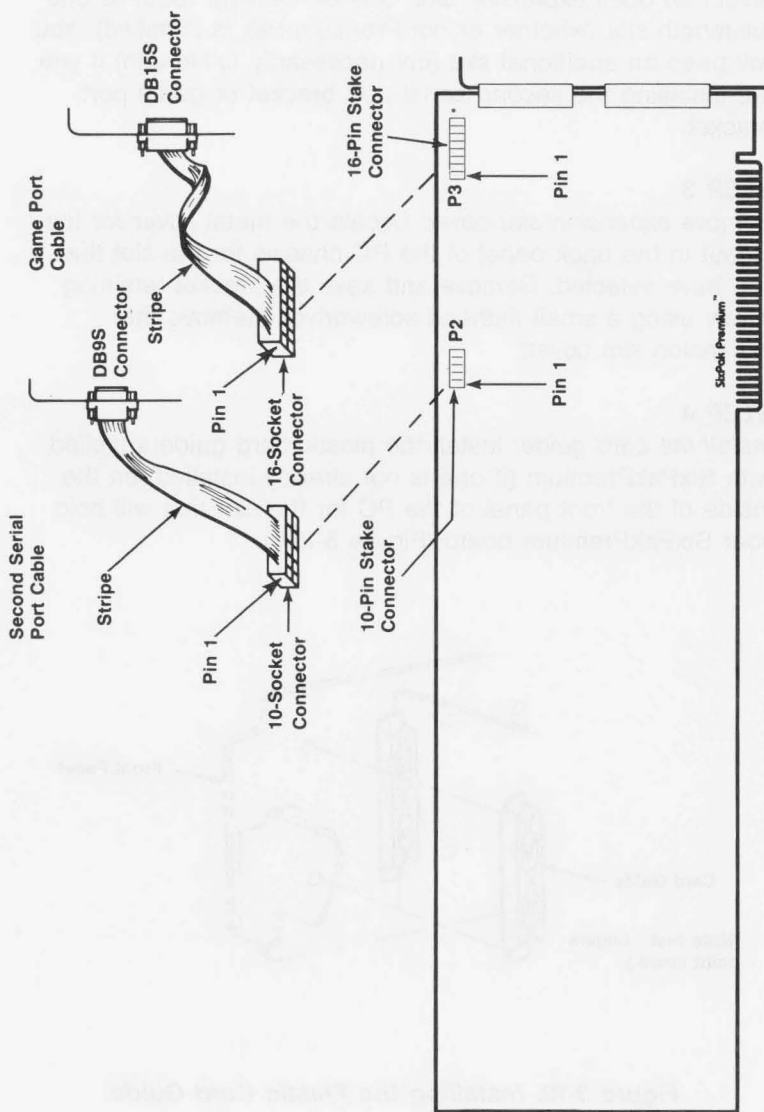

Figure 3-9. Connecting SixPakPremium Cables.



## STEP 2

*Select an open expansion slot:* SixPakPremium requires one full-length slot (whether or not Premium-Pak is installed). You will need an additional slot (not necessarily full-length) if you are installing the second serial port bracket or game port bracket.

## STEP 3

*Remove expansion slot cover:* Locate the metal cover for the cutout in the back panel of the PC chassis for the slot that you have selected. Remove and save the bracket retaining screw using a small flathead screwdriver. Remove the expansion slot cover.

## STEP 4

*Install the card guide:* Install the plastic card guide supplied with SixPakPremium (if one is not already installed) on the inside of the front panel of the PC for the slot that will hold your SixPakPremium board (Figure 3-10).

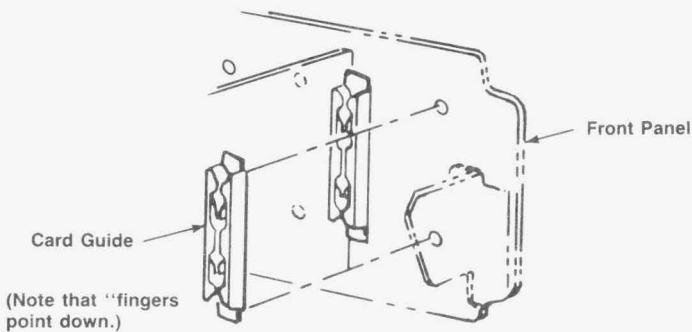

**Figure 3-10. Installing the Plastic Card Guide.**

**STEP 5**

*Install the SixPakPremium board:* Line up your SixPakPremium board and position its front bottom corner in the card guide channel. Position any wires or ribbon cables so they will pass either beneath or above the installed board and will not be damaged during installation. Lower the board until its edge connector is resting on the expansion slot receptacle. Using an evenly distributed pressure, press the SixPakPremium straight down until it seats in the expansion slot (Figure 3-11).

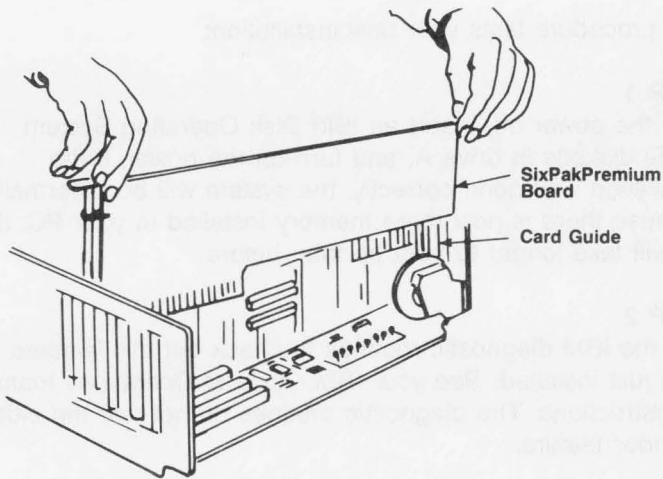

**Figure 3-11. Installing the SixPakPremium Board.**

**STEP 6**

*Secure the board to the rear of the PC chassis:* Use the screw you removed from the expansion slot cover in STEP 3.

**STEP 7**

*Replace PC cover:* Carefully slide the cover from the front until it stops securely against the rear panel. Reinstall the cover mounting screws you removed earlier.

**STEP 8**

*Install cables:* Replace the power cord to the system unit and be sure that the keyboard and the monitor connectors are plugged in. Reattach any other cables and connectors you removed previously.

**STEP 9**

*Now you are ready to power up.*

### **3.5 Testing the New Installation**

This procedure tests your new installation:

**STEP 1**

With the power off, insert an IBM Disk Operating System (DOS) diskette in drive A, and turn on the power. If the installation was done correctly, the system will boot normally. Because there is now more memory installed in your PC, the PC will take longer to boot up than before.

**STEP 2**

Run the IBM diagnostic routines to check out the features you have just installed. See your IBM *Guide to Operations* manual for instructions. The diagnostic routines do not test the clock-calendar feature.

**STEP 3**

Use the clock-calendar software (included on your SuperPak diskette) to set the correct time and date on your SixPakPremium. Section 5 tells you how to set your SixPakPremium clock-calendar.

### **3.6 Changing the Standard Configuration**

This section tells you how to change the standard SixPakPremium configuration.

### 3.6.1 Starting Memory Address

Figure 3-12 shows the possible SixPakPremium starting addresses. This setting tells SixPakPremium how much conventional memory is already installed in your PC, and prevents parity errors at power-on time, during memory sizing.

Starting Memory Address	SW1-1	SW1-2	SW1-3	SW1-4
0 KB	OFF	OFF	OFF	OFF
64 KB	ON	OFF	OFF	OFF
128 KB	OFF	ON	OFF	OFF
192 KB	ON	ON	OFF	OFF
*256 KB	OFF	OFF	ON	OFF
320 KB	ON	OFF	ON	OFF
384 KB	OFF	ON	ON	OFF
448 KB	ON	ON	ON	OFF
512 KB	OFF	OFF	OFF	ON
576 KB	ON	OFF	OFF	ON
**640 KB	OFF	ON	OFF	ON

\* Default setting.

\*\* This starting address allocates all SixPakPremium memory as expanded memory. Set any additional AST expanded memory boards (such as *RAMpage!*) installed in the same PC to use a starting address of 640 KB.

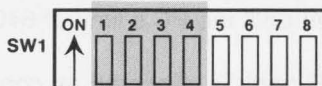

Figure 3-12. Starting Memory Address.

### 3.6.2 Parity Checking

Figure 3-13 shows how to enable or disable parity error checking. To ensure the most reliable memory operation, leave parity checking enabled.

Parity Checking	SW1-8
*Enabled	ON
Disabled	OFF
*Default setting.	

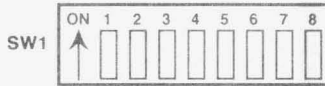

Figure 3-13. Parity Error Checking.

### 3.6.3 SixPakPremium Conventional Memory Size

Figure 3-14 shows the SixPakPremium maximum conventional memory size settings. Conventional memory is the user-addressable memory between 0 and 640 KB. Conventional memory can be added until the PC's limit of 640 KB is reached.

Each enabled 256-KB bank is allocated as conventional (non-paged) memory until a total of 640 KB of conventional memory is present. All remaining SixPakPremium memory is then allocated as expanded (paged) memory.

For example, your PC has 256 KB of conventional memory already installed on the system board, and you want to use SixPakPremium to fill out conventional memory to its 640-KB maximum. SixPakPremium must meet these requirements:

- Adequate SixPakPremium memory must be installed.
- The conventional memory size setting must be equal to or greater than the amount you want.

To provide 384 KB of conventional memory, two banks (512 KB) must be installed on SixPakPremium. To provide 384 KB of conventional memory, set SixPakPremium conventional memory size to *up to 512 KB*. This setting allocates 384 KB as system memory. The remaining 128 KB of that 512 KB is then allocated as expanded memory.

### NOTE

To prevent parity errors, do not set the conventional memory size for more memory than is actually installed on SixPakPremium. For example, if 256 KB is installed on SixPakPremium, do not set the conventional memory for size up to 512 KB.

To allocate all SixPakPremium memory as expanded memory, simply set the starting address to 640 KB. This ensures that no SixPakPremium is allocated as conventional memory, regardless of the conventional memory size setting.

SixPakPremium Conventional Memory Size	SW2-7	SW2-8
0 KB	ON	ON
*Up to 256 KB	OFF	ON
Up to 512 KB	ON	OFF
Up to 640 KB	OFF	OFF

\*Default setting.

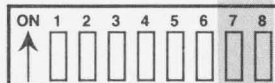

Figure 3-14. SixPakPremium Conventional Memory Size.

### 3.6.4 Base I/O Address

Figure 3-15 shows the SixPakPremium base I/O address settings. This setting defines the base I/O address used by SixPakPremium to communicate with the PC, so that it can make use of expanded memory.

**NOTE**

If more than one AST expanded memory board is installed in a PC, each must use a different I/O address. To prevent I/O address conflicts, make sure that no other devices in your PC use the same I/O address.

Base I/O	SixPakPremium Switch Settings			
	SW2-1	SW2-2	SW2-3	SW2-4
0208	ON	ON	ON	ON
*0218	ON	ON	ON	OFF
0258	ON	OFF	ON	OFF
0268	ON	OFF	OFF	ON
02A8	OFF	ON	OFF	ON
02B8	OFF	ON	OFF	OFF
02E8	OFF	OFF	OFF	ON

\* Default setting

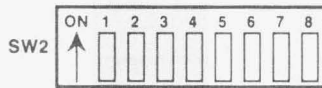

Figure 3-15. SixPakPremium Base I/O Address Settings.

### 3.6.5 Serial Port (COM1/COM2)

Figure 3-16 shows the possible SixPakPremium serial port assignments.

If the optional second serial port is not installed, it must be disabled to avoid I/O address conflicts.

\*First serial port enabled as COM1, using IRQ4:

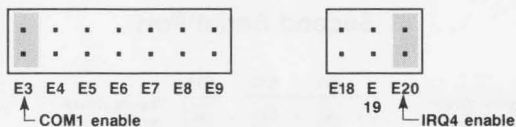

First serial port enabled as COM2, using IRQ3:

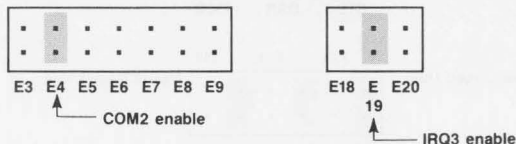

\*Second serial port enabled as COM2, using IRQ3:

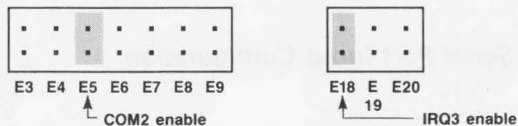

\*Default configuration

For all serial ports, remove shorting plugs to completely disable port.

**Figure 3-16. Serial Port COM Assignments.**



### 3.6.6 Serial Port Inputs

Figure 3-17 shows how to configure serial inputs CTS, DSR, and DCD to be driven by the connected device or "forced true". This parameter provides a convenient means of reconfiguring the serial port for special requirements of certain serial devices (the documentation for the serial device will tell you if you need to force any of the serial inputs true).

#### First Serial Port

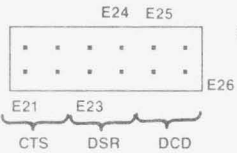
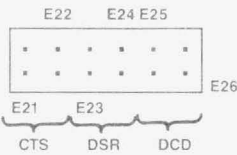

#### Second Serial Port

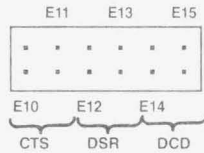
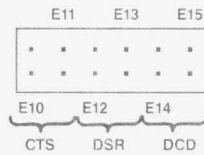

*Figure 3-17. Serial Port Input Configuration.*

### 3.6.7 Parallel Port

Figure 3-18 shows how to configure the SixPakPremium parallel port as LPT1, LPT2, or disabled.

#### NOTE

If a display adapter with a built-in parallel port is installed in your PC, SixPakPremium LPT1 will respond as LPT2, and LPT2 will respond as LPT3. To avoid a conflict with the AST ColorGraphPlus parallel port, configure the SixPakPremium parallel port as LPT2.

\*LPT1 (I/O 378-37F) enabled:

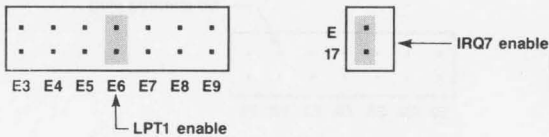

LPT2 (I/O 278-27F) enabled:

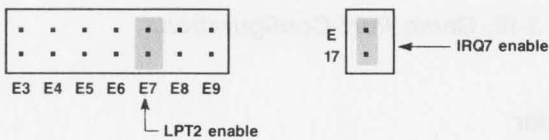

Parallel port disabled:

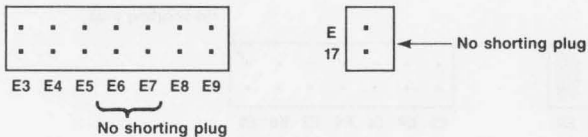

\*Default setting

**Figure 3-18. Parallel Port Configuration.**

**NOTE**

If a display adapter (such as the IBM monochrome adapter) with a built-in parallel port is installed, LPT1 will respond as LPT2, and LPT2 will respond as LPT3.

**3.6.8 Game Port**

Figure 3-19 shows how to enable or disable the SixPakPremium game port.

If the optional game port is not installed, it should be disabled to avoid I/O address conflicts.



**Figure 3-19. Game Port Configuration.**

**3.6.9 Clock-Calendar**

Figure 3-20 shows how to enable or disable the SixPakPremium clock-calendar.

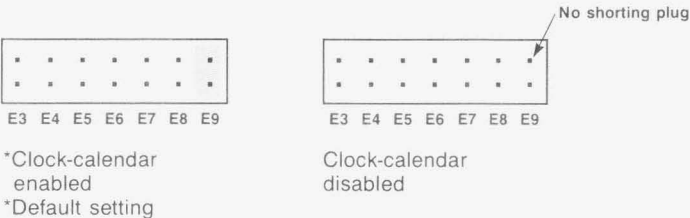

**Figure 3-20. Clock-Calendar Configuration.**

### 3.6.10 Dual Page Mode

Figure 3-21 shows how to enable or disable Dual Page mode. Dual Page mode allows expanded memory to maintain two sets of mapping registers, which ensures best proper multitasking operation. Unless you have a special reason to do otherwise, leave Dual Page mode enabled.

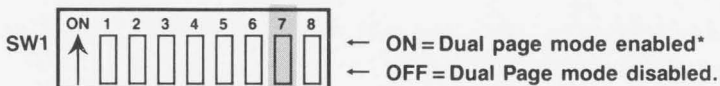

\*Default setting

*Figure 3-21. Dual Page Mode Configuration.*

(This page intentionally left blank)

## SECTION 4

# SOFTWARE CONFIGURATION AND INSTALLATION

This section tells you how to run the SuperPak INSTALL program. INSTALL installs the simple, basic configuration of the SuperPak software on your PC boot disk.

You can install these SuperPak programs:

- fASTdisk.
- SuperDrive.
- SuperSpool.
- REMM.SYS (AST expanded memory manager; an additional program, REX.SYS, is also automatically installed transparently to you when you install the AST expanded memory manager).
- ASTCLOCK.

### NOTE

All SuperPak files may not pertain to your particular AST product. Your SuperPak diskette contains a READ.ME file that describes which files are applicable to your product. For more information on SuperPak software, see your *SuperPak User's Manual*. For more information on AST expanded memory software, see Appendix C of this manual.

You will have to modify your AUTOEXEC.BAT and/or CONFIG.SYS files (using a text editor) after running INSTALL if you want to send printer output to a serial (not parallel) port, or if you want to use advanced parameters for the SuperPak software.

## 4.1 Using INSTALL

For your convenience, INSTALL uses the a screen and keyboard interface design similar to popular spreadsheet programs:

- The main SuperPak INSTALL menu offers several options: the currently selected option is highlighted in reverse video. To select an option, press the right- or left-arrow keys on the numeric keypad to the right of your keyboard. Select items within each option by pressing the up- or down- arrow keys.
- To create a highlighted option, press the **<Enter>** or **<Ins>** key.
- To call up the INSTALL edit box (applicable to the FASTdisk, SuperDrive, and SuperSpool options only): Press up- or down-arrow key to select the item you want to modify. Press **<Enter>** to invoke the edit box.
- Press **<F1>** to bring up a help screen that corresponds to the currently-selected option or item.
- Press **<Ctrl>-C** to abort the INSTALL program without changing your AUTOEXEC.BAT or CONFIG.SYS files.
- The cursor appears as an underline character when an alphanumeric entry is required from you.

Once you have installed and configured your SuperPak options, INSTALL modifies the AUTOEXEC.BAT and CONFIG.SYS files on your boot disk. If those files do not already exist on your boot disk, INSTALL will create them for you. If those files do already exist on your boot disk, any existing statements will remain, and INSTALL appends its statements to the end of the files.

AUTOEXEC.BAT is a batch file that contains commands that are automatically executed when you boot up your PC. CONFIG.SYS contains the software drivers that allow devices that are external to your PC (such as REMM, REX, and FASTdisk) to function).

INSTALL first creates FASTdisks, SuperDrives, and the SuperSpool from available extended memory, then uses conventional memory if extended memory is exhausted. If you create a device that is larger than available extended memory, this message is displayed at the bottom of the screen:

Not enough extended memory—switching to conventional

#### NOTE

The term “extended memory” in the INSTALL program refers to SixPakPremium memory that *emulates* extended memory (non-paged memory above 1 MB) via the REX.SYS software program. REX allows you to set up RAM disks and print spoolers outside of the 0- to 640-KB area.

Each device can be composed of only one memory type (extended *or* conventional). INSTALL allocates available expanded memory as extended memory only as necessary to create the device.

## 4.2 Running the INSTALL Program

Follow these steps to use the SuperPak INSTALL program:

### STEP 1

*Back up the SuperPak diskette:* Store the master diskette in a safe place. You can then use the master diskette to back up your software if your working disk is lost or damaged.



## STEP 2

*Start the program:* With the backup copy of your SuperPak diskette in the default drive, enter this command from the DOS prompt:

**INSTALL <Enter >**

### NOTE

To ensure proper operation, run INSTALL from DOS (*not* from another program, such as DESQview) only.

The initial INSTALL screen shown in Figure 4-1 will appear:

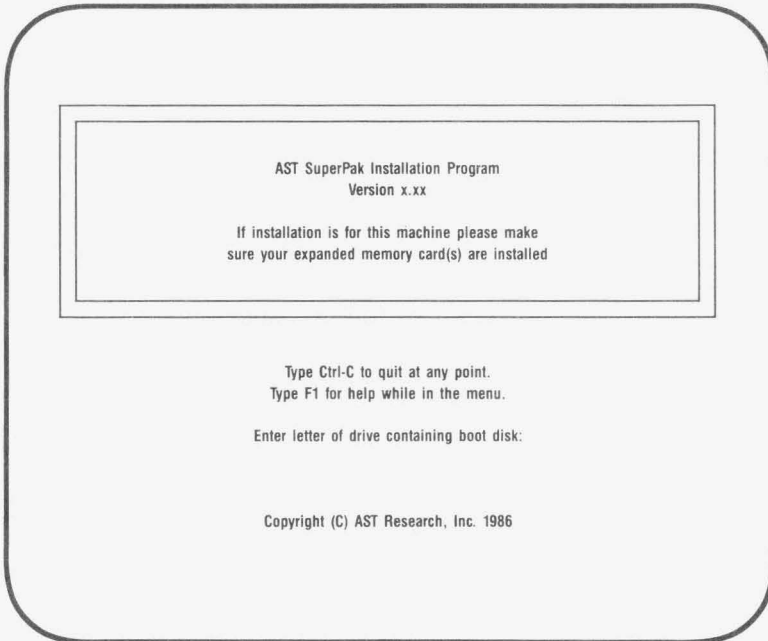

**Figure 4-1. Initial INSTALL Screen.**

*Enter letter of drive containing boot disk:* This tells INSTALL where to find your AUTOEXEC.BAT and/or CONFIG.SYS files (the files that automatically execute certain commands when you boot your PC). When the INSTALL program is complete, it will modify the AUTOEXEC.BAT and CONFIG.SYS files (or create them if they do not already exist) to install your software. To select the default drive as the drive containing the boot disk, press <Enter>.

These questions will then appear on your screen:

Is your video card one of the following (Y/N)?

- IBM Color Graphics Adapter or compatible (Y/N)?
- IBM Monochrome, Hercules Graphics Adapter or compatible (Y/N)?
- IBM Enhanced Graphics Adapter or compatible (Y/N)?

For each question press **Y** (if that type of video card is installed) or **N** (if that type of video card is not installed). These questions allow INSTALL to avoid conflicts with the memory area used by your video card.

Your screen will then display this question:

Is installation for this machine (Y/N)?

Press **Y** if you are installing SuperPak software for the PC you are using now. This causes this message to be displayed on the screen:

Testing for expanded memory boards...

INSTALL then goes to the main menu shown in Figure 4-2.

Press **N** if you are installing SuperPak software for another PC. This causes INSTALL to display these questions about the PC for which you are installing software:

Is your computer a PC-AT or AT-compatible (y/n)?

Enter amount of conventional memory in K bytes:

Enter amount of expanded memory in K bytes:

Enter number of floppies and RAM diskettes (1-4):

*Is your computer a PC-AT or AT-compatible (y/n)?*: Press **Y** if you are installing software for a PC-AT or compatible. Press **N** if you are installing software for a PC that is not a PC-AT.

*Enter amount of conventional memory in K bytes*: Enter the number of kilobytes (KB) (from **0** to **640**) of conventional memory for the PC whose software you are installing. Conventional memory (as opposed to expanded or extended memory) is the PC system memory between 0 and 640 KB. Pressing <Enter> is equivalent to entering "0".

*Enter amount of expanded memory in K bytes*: Enter the number of KB (from **0** to **15360** — 15 megabytes (MB)) of expanded memory for the PC whose software you are installing. The amount of expanded memory is the total amount of memory on your AST expanded memory product that is *not* allocated as conventional memory.

For example, if you have a 2-MB AST board and you have allocated 384 KB of the board's memory as conventional memory, enter "1664" (2048 minus 384) for the amount of expanded memory.

Expanded memory (as opposed to conventional or extended memory) is also known as "paged memory", and is available for paging or extended memory emulation. Pressing <Enter> is equivalent to entering "0".

*Enter number of floppies and RAM diskettes (1-4):* Enter the number (from 1 to 4) of floppy diskettes (including random access memory (RAM) floppy diskettes, such as SuperDrive), then press <Enter>.

Once you have answered all the questions in the initial INSTALL screen, the main menu shown in Figure 4-2 appears. Notice that the amounts of conventional and expanded memory you have entered appear at the bottom of the screen. "Extended memory" refers to memory that is *emulated* using REX.SYS to enable fASTdisk, SuperDrive, and SuperSpool outside of the 0- to 640-KB area. You will notice that as extended memory is allocated, it is subtracted from expanded memory.

AST SuperPak Installation Program

fASTdisk

SuperDrive

SuperSpool

AST Expanded Memory

REMM.SYS installed

Clock  
 ASTClock not installed

Expanded Memory Configuration (I/O port addresses)		Conventional Memory: TOTAL = 0K
Board #1 xxxx	Board #3 xxxx	REMAINING = 0K
Board #2 xxxx	Board #4 xxxx	Extended Memory: TOTAL = 0K
		Expanded Memory: TOTAL = 0K

Valid keys: F1=help, ESC=exit, --, | ENTER, INS

**Figure 4-2. Main INSTALL Menu.**

- *fASTdisk* — the program that simulates up to two fixed disk drives in RAM. You can change the size and memory type for each fASTdisk.

- *SuperDrive* — the program that simulates 360-KB floppy disk drives in RAM. INSTALL can install up to two SuperDrives in your system. You can change the letter designation and memory type for each SuperDrive.
- *SuperSpool* — the program that creates a RAM print spooling buffer, freeing your PC for other work while your files print. You can change the device name, size, and memory type for the SuperSpool buffer.
- *Expanded Memory Manager* — the program that enables expanded memory, providing maximum performance with new multitasking/windowing software. You can enable or disable this feature.
- *Clock* — the clock-calendar program that keeps track of the time and date, even when your PC is off. You can enable or disable this feature. (Once you have installed the clock software, you must still set the correct time and date after rebooting your PC, as described in the clock- calendar section of this manual.)

#### 4.2.1 Installing fASTdisk

This option allows you to create up to two RAM fixed disk drives (default size: 512 KB each). To create a fASTdisk:

1. Press the right- or left-arrow key to highlight "fASTdisk".
2. Press <Enter> or <Ins> once for each fASTdisk you want to create. If you press <Enter> more than twice, this message will appear at the bottom of the screen:

Maximum of two fASTdisks allowed

The memory totals in the lower right corner of the screen (Figure 4-3) will show 512 KB subtracted from expanded memory, and added to extended memory, each time you create a fASTdisk.

To change the size or memory type of a fASTdisk:

1. Press right- or left-arrow key to highlight "fASTdisk".
2. Press the down-arrow key to highlight the fASTdisk you want to modify (Figure 4-3 shows fASTdisk "1" highlighted).
3. Press <Enter> to invoke the edit box, shown in Figure 4-3.

The screenshot shows the AST SuperPak Installation Program interface. At the top is a title box "AST SuperPak Installation Program". Below it, the "fASTdisk" section lists two disks: "1: 512K ( Extended )" and "2: 512K ( Extended )". The first disk is highlighted with a box. To the right, the "fASTdisk Options" box is open, showing "Size in K bytes = 512" and "Memory Type = Extended". Below this, the "SuperSpool" section is empty, and the "AST Expanded Memory" section shows "REMM.SYS not installed". The "Clock" section shows "ASTClock not installed". At the bottom, a large box contains "Expanded Memory Configuration (I/O port addresses)" with fields for Board #1, #2, #3, and #4, and "Conventional Memory" statistics: TOTAL, REMAINING, and Expanded Memory. At the very bottom, it lists valid keys: F1=help, ESC=exit, --, |, ENTER, INS.

```

AST SuperPak Installation Program

fASTdisk
1: 512K ( Extended )
2: 512K ( Extended )

fASTdisk Options
Size in K bytes = 512
Memory Type = Extended

SuperSpool

AST Expanded Memory
REMM.SYS not installed

Clock
ASTClock not installed

Expanded Memory Configuration
(I/O port addresses)
Board #1 xxxx Board #3 xxxx
Board #2 xxxx Board #4 xxxx

Conventional Memory: TOTAL = xxxK
REMAINING = xxxK
Expanded Memory: TOTAL = xxxxK
Expanded Memory: TOTAL = xxxxK

Valid keys: F1 = help, ESC = exit, --, |, ENTER, INS
  
```

Figure 4-3. INSTALL with fASTdisk Edit Box.

4. Press the up- or down-arrow key to highlight the parameter you want to modify (Figure 4-3 shows the fASTdisk size parameter highlighted).

5. To change the size: Enter the new size (in KB) of the fASTdisk (from a minimum of 1 KB to a maximum of all available PC memory). Your PC will beep if you enter too many digits. This message will appear at the bottom of your screen if you enter a non-numeric character:

Input must be a decimal digit

To change the memory type: Press the right- or left-arrow key to select the memory type ("Conventional" or "Extended") you want the fASTdisk to use.

6. Press <Esc> to exit the edit box. Notice that the memory allocation at the lower right corner of the screen changes to reflect changes you have made.

To delete a fASTdisk:

1. Press the right- or left-arrow key to highlight "fASTdisk".
2. Press the down-arrow key to highlight the fASTdisk you want to delete.
3. Press <Del> — the fASTdisk will disappear from the screen.

#### 4.2.2 Installing SuperDrive

This option allows you to create up to three 360-KB RAM floppy disk drives (depending on PC system board switch settings for the number of floppy drives).

To create a SuperDrive:

1. Press the right- or left-arrow key to highlight "SuperDrive".
2. Press <Enter> once for each SuperDrive you want to create.

Watch the memory totals at the lower right corner of the screen (see Figure 4-4): 360 KB is subtracted from expanded memory, and added to extended memory, each time you create a SuperDrive.

INSTALL assumes your PC has one floppy diskette drive installed (therefore the first SuperDrive will be B:). If you told INSTALL that your PC has one floppy installed (see the INSTALL initial screen shown in Figure 4-1) and you try to create a SuperDrive, this message will be displayed at the bottom of your screen:

Not enough disk devices to add SuperDrive

If, for example, you attempt to create two SuperDrives when you have entered "2" for the total number of floppies and RAM diskettes, this message would be displayed at the bottom of your screen:

Maximum of one SuperDrive allowed

To change the letter designation or memory type of a SuperDrive:

1. Press the right- or left-arrow key to highlight "SuperDrive".
2. Press the down-arrow key to highlight the SuperDrive you want to modify (Figure 4-4 shows SuperDrive B: highlighted).
3. Press < **Enter** > to invoke the edit box, shown in Figure 4-4.



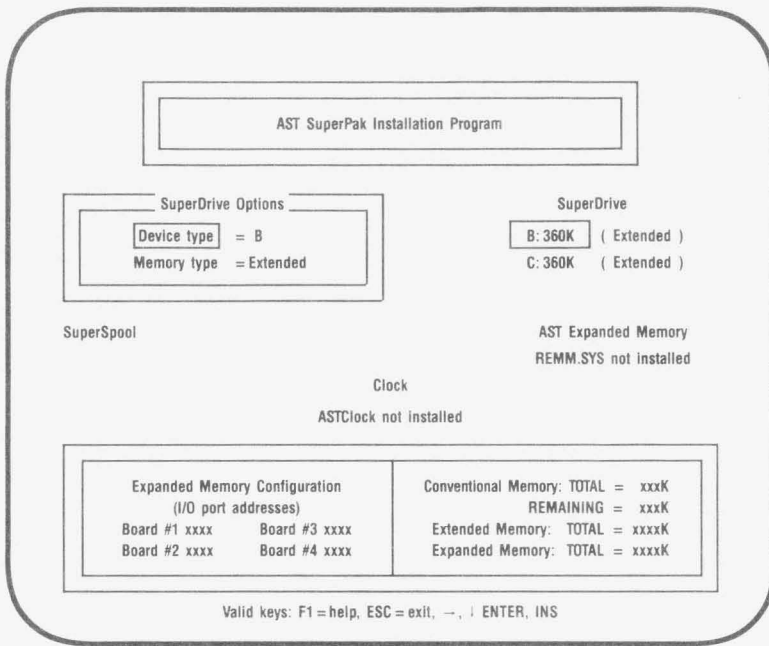

Figure 4-4. INSTALL with SuperDrive Edit Box.

4. Press the up- or down-arrow key to highlight "Device" or "Memory type" (Figure 4-4 shows "Device" highlighted).
5. To change the letter designation: Press the right- or left-arrow key to select the letter you want (A:, B:, C:, or D:).

To change the memory type: Press the right- or left-arrow key to select the memory type ("Conventional" or "Extended") you want the SuperDrive to use.

6. Press <Esc> to exit the edit box. Notice that the memory allocation at the lower right corner of the screen now reflects changes you have made.

To delete a SuperDrive:

1. Press the left- or right-arrow key to highlight "SuperDrive".
2. Press the down-arrow key to highlight the SuperDrive you want to delete.
3. Press <Del> to delete the SuperDrive.

#### 4.2.3 Installing the AST Expanded Memory Manager

This option automatically installs REMM.SYS and REX.SYS in your CONFIG.SYS file. REMM.SYS and REX.SYS are the software drivers that make your expanded memory available for paging and emulation of extended memory.

#### NOTE

The expanded memory manager software installed by the INSTALL program is appropriate for most applications. However, software developers who want to edit the REMM and REX command lines in the CONFIG.SYS file can use the parameters described in Appendix C of this manual.

To install or delete AST expanded memory software:

1. Press the left- or right-arrow key to highlight "AST Expanded Memory Manager".
2. Press <Enter> to select "REMM.SYS installed" or "REMM.SYS not installed". If you press the down-arrow key, this message will appear at the bottom of the screen:

Device can only be enabled or disabled

#### 4.2.4 Installing the Clock

This option installs the ASTCLOCK program. ASTCLOCK maintains the time and date even when your PC is off and provides that information to DOS whenever you boot up your PC. You must still initialize ASTCLOCK as described in the clock-calendar section of this manual.

To install or delete ASTCLOCK software:

1. Press the left- or right-arrow key to highlight "Clock".
2. Press <Enter> to select "ASTClock installed" or "ASTClock not installed". If you attempt to invoke an edit box (by pressing the down-arrow key) this message will appear at the bottom of the screen:

Device can only be enabled or disabled

#### 4.2.5 Installing SuperSpool

This option allows you to create one RAM print spooler buffer. You must edit the SUPERSPL command in the AUTOEXEC.BAT file if you are spooling to a serial printer port or you are changing any default parameter (see your *SuperPak User's Manual* for more details).

INSTALL will first attempt to create a SuperSpool buffer from available extended memory, then uses conventional memory. If you create a SuperSpool that is larger than available extended memory, INSTALL will create a buffer from the extended memory that is available. If no extended memory is available, this message is displayed at the bottom of the screen:

Not enough extended memory—switching to conventional

If no extended or conventional memory is available, this message is displayed at the bottom of the screen:

Not enough memory for spooler

The SuperSpool buffer is composed of only one memory type (extended or conventional). INSTALL allocates available expanded memory as extended memory to create a SuperSpool.

To create a SuperSpool:

1. Press the left- or right-arrow key to highlight "SuperSpool".
2. Press <Enter> to create a SuperSpool.

If you press <Enter> again this message will be displayed at the bottom of the screen:

Maximum of one spooler allowed

To change the device name, size, or memory type of the SuperSpool buffer:

1. Press the left- or right-arrow key to highlight "SuperSpool".
2. Press the down-arrow key to highlight the SuperSpool buffer ("LPT1:" is highlighted in Figure 4-5).

3. Press <Enter> to invoke the edit box, shown in Figure 4-5.

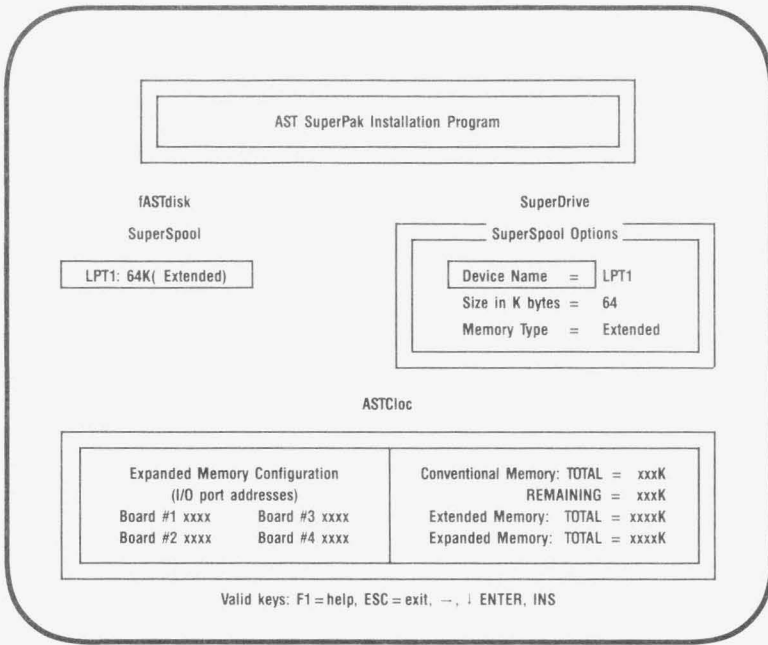

**Figure 4-5. INSTALL with SuperSpool Edit Box.**

4. Press the up- or down-arrow key to highlight the parameter you want to modify ("Device Name" is highlighted in Figure 4-5).
5. To change the device name: Press the left- or right-arrow key to select "LPT1:" or "LPT2:".

To change the size: Enter the new size (in KB) of the SuperSpool (from a minimum of 1 KB to a maximum of the all available PC memory). Your PC will beep if you enter too many digits. This message will appear at the bottom of your screen if you enter a non-numeric character:

Input must be a decimal digit

To change the memory type: Press the left- or right-arrow key to select extended or conventional memory.

6. Press <**Esc**> to exit the edit box. Notice that the memory allocation at the lower right corner of the screen reflects any changes you have just made.

To delete SuperSpool:

1. Press the left- or right-arrow key to highlight "SuperSpool".
2. Press the down-arrow key to highlight "LPTx:".
3. Press <**Del**> to delete the SuperSpool.

#### 4.2.6 Saving the Installation

1. Press <**Esc**>. This question will appear at the bottom of the screen:

Are you sure you want to quit (y/n)?

Press **Y** to exit INSTALL. Press **N** to return to the main INSTALL menu.

2. If you press **Y**, this question appears at the bottom of the screen:

Do you want to save configuration (y/n)?

Press **Y** to save the SuperPak software you have just configured using the INSTALL program. Pressing **N** exits INSTALL without making any changes.

3. If you save the configuration, these messages flash at the bottom of the screen:

Writing CONFIG.SYS to x: \...

Writing AUTOEXEC.BAT to x: \...

where x: is the drive containing the boot disk.

4. The screen will then clear and show this message:

For the configuration process to be complete, the following SuperPak utility files need to be present on your boot disk:

The above message is followed by a list of the files necessary to install your SuperPak software, and this question is displayed:

Do you want these files copied to your boot disk (Y/N)?:

5. If you press **Y**, your screen will display this message:

Enter the letter of the disk drive  
containing your SuperPak software:

Enter the letter of the drive containing SuperPak software. Your screen will then list the appropriate files as they are copied from the SuperPak diskette to your boot disk.

If there is an error copying SuperPak software to your boot disk, this message will be displayed:

Error copying utility files to drive x:

where x: is the letter of the drive containing the boot disk.

Check that the boot disk is not write-protected, that the SuperPak software is in the specified drive, and that the disk drives are closed.

6. If you press **N** (do not copy SuperPak files to the boot disk), or once the SuperPak files have been copied, this message appears on your screen:

Configuration is now complete.

You will need to reboot the system for your updated configuration to take effect.

7. Press **<Ctrl>-<Alt>-<Del>** to reboot your PC. If you installed one fASTdisk, one SuperDrive B:, one SuperSpool buffer, the clock-calendar, and enabled AST memory manager software, your AUTOEXEC.BAT and CONFIG.SYS files will contain the following lines at the end of the file (assuming you did not change any default parameters):

<i>AUTOEXEC.BAT</i>	<i>CONFIG.SYS</i>
astclock /r	device = remm.sys /x = B000-BFFF
superdrv b:/extm	device = rex.sys 936
superspl lpt1:/extm	device = fastdisk.sys/extm



The following information is provided for your reference. It is intended to assist you in understanding the details of the project and the various components involved. Please refer to the attached documents for further information.

### Project Overview

The project aims to develop a comprehensive system that will streamline our operations and improve efficiency. This system will be implemented in phases, starting with the core functionality and then moving on to more advanced features.

The project is being managed by a dedicated team of professionals who are committed to delivering high-quality results. We will provide regular updates and reports to keep you informed of the progress. Your input and feedback are highly valued and will be taken into account throughout the project.

(This page intentionally left blank)

## SECTION 5

### CLOCK-CALENDAR

The SixPakPremium clock-calendar can answer the TIME and DATE prompts that the Disk Operating System (DOS) issues each time you boot the system. The PC is not aware of the existence of any expansion card clock unless you use the clock software supplied on your SuperPak diskette.

#### NOTE

You must use a version 6.0 (or later) SuperPak diskette with your SixPakPremium.

The SixPakPremium clock-calendar features include:

- A 24-hour clock, maintained in an advanced microprocessor chip on the SixPakPremium board.
- Battery backup power supply (with a battery life of approximately one year).
- Replaceable lithium battery.
- Full PC-DOS compatibility.
- Automatic accounting for leap year.

#### 5.1 Configuring the Clock-Calendar

SixPakPremium is shipped from the factory with the clock-calendar enabled. To confirm the default configuration, check that a shorting plug is installed at jumper block position E8, as shown in Figure 5-1.

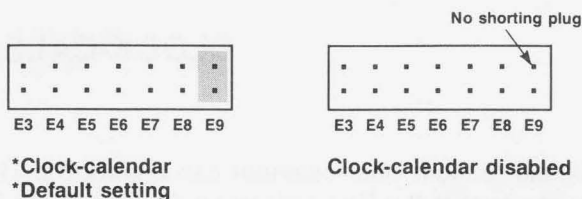

**Figure 5-1. Clock-Calendar Factory Configuration.**

### 5.1.1 Disabling the Clock-Calendar

You can disable the clock-calendar by removing the shorting plug shown in Figure 5-1. You might want to disable the clock-calendar to avoid a conflict between the I/O addresses used by the SixPakPremium clock and other devices installed in your PC. The SixPakPremium clock-calendar uses I/O addresses 2C0 through 2C7 hexadecimal.

## 5.2 Preparing Your PC Boot Disk

Once you've installed your SixPakPremium card, you can prepare your PC boot disk to automatically initialize the time and date each time that you boot the system.

This section tells you how to prepare your DOS boot disk to automatically invoke the clock-calendar. You can also use the INSTALL program (described in Section 4) to install the clock-calendar.

### STEP 1

If you have not already done so, copy the ASTCLOCK.COM program from a SuperPak diskette (version 6.0 or later) to your PC boot disk.

If you are unsure how to COPY a file, consult your *DOS Manual*.

**STEP 2**

If your DOS boot disk already has an AUTOEXEC.BAT file, update that file to include the ASTCLOCK command. To see the current contents of your AUTOEXEC file, enter this command at the DOS prompt (with AUTOEXEC.BAT in the default drive):

**TYPE AUTOEXEC.BAT <Enter>**

Your screen will display the contents of your AUTOEXEC file. Now you must create a new AUTOEXEC file in which the command ASTCLOCK precedes these other command(s). Enter this command sequence:

**COPY CON: AUTOEXEC.BAT <Enter>**

**ASTCLOCK <Enter>**

.  
.  
.  
(other commands)

**<Function key F6> <Enter> or <Ctrl-Z> <Enter>**

If your boot disk has no AUTOEXEC file, use the sequence above to create one (the only command in the file will be ASTCLOCK).

For more information about AUTOEXEC files or the DOS COPY command, see your *DOS Manual*.

**NOTE**

If you want ASTCLOCK to display the date in European format (dd/mm/yy) when you boot the system, substitute the command ASTCLOCK/E for ASTCLOCK in your AUTOEXEC file. Specifying the /E parameter in the AUTOEXEC file only changes how ASTCLOCK shows the date when you boot the system; it does not affect how DOS or other software displays the date.

### STEP 3

Reboot your PC by pressing the <Ctrl-Alt-Del> key sequence.

The ASTCLOCK command will display the time and date on the screen. If necessary, use the ASTCLOCK /R parameter to set the TIME and DATE on the SixPakPremium as detailed in Section 5.3.

## 5.3 Setting the TIME & DATE

This section tells you how to set the time and date in the SixPakPremium clock chip — allowing you to maintain the correct time and date even when the PC is turned off.

### NOTE

You must use a version 6.0 (or later) SuperPak diskette to set the SixPakPremium clock chip.

Once you have copied ASTCLOCK to your PC boot disk, you can update the clock-calendar on the SixPakPremium internal microprocessor chip. DOS TIME and DATE commands only update the system's time and date parameters in memory; they don't permanently update the values stored in the SixPakPremium clock chip until you execute this procedure:

### STEP 1

Boot the system with a disk that contains the ASTCLOCK.COM program.

### STEP 2

Enter this command:

**ASTCLOCK /R<Enter>**

Your PC will then display a message like this (the actual date and time will be different):

```
ASTClock      Version x.xx  
(c) Copyright AST Research, Inc.,  
1982, 1984, 1985
```

```
resident clock/calendar  
DATE & TIME processors loaded.
```

```
Current date is 05/21/86  
Current time is 08:07:56.65
```

### NOTE

If you want **ASTCLOCK** to display the date in European format (dd/mm/yy) when you enter this command, type **ASTCLOCK/R/E** instead of **ASTCLOCK/R**. Specifying the /E parameter only changes how **ASTCLOCK** shows the date when you enter this command; it does not affect how DOS or other software displays the date.

### STEP 3

Enter this command:

```
DATE<Enter>
```

Your PC will display the current date (the actual date displayed may be different):

```
Current date is Tue 5-21-1986  
Enter new date:
```

Enter the new month, day, and year as follows:

```
mm-dd-yy<Enter>
```

where *mm* is the one- or two-digit month designation, *dd* is the day, and *yy* is the year.

If you do not want to change the date, press <**Enter**> only.

**STEP 4**

Enter this command:

**TIME** <Enter>

Your PC will then display the current time (the actual time displayed may be different):

Current time is 8:14:15.82

Enter new time:

Enter the new hour, minute, and second as follows:

**hh:mm:ss** <Enter>

where *hh* is the hour, *mm* is the minute, and *ss* is the second. Be sure to use 24-hour format for the hour (that is, 1:00 PM = 13, 2:00 PM = 14, and so forth).

Do not enter hundredths of a second. If you do not want to change the time, press <**Enter**> only.

Hint: For maximum accuracy, type in a time that is 10 to 15 seconds ahead of the actual time, then observe a digital watch, and press <**Enter**> when the seconds reading on the watch catches up to the value that you typed in.

**STEP 5**

Reboot your computer by pressing the <**Ctrl-Alt-Del**> key sequence.

**NOTE**

Selecting the ASTCLOCK "/R" parameter selects the *resident* option, which allows you to update the date and time in both PC memory and the SixPakPremium clock chip (you cannot update the clock chip unless a certain portion of the ASTCLOCK.COM program is resident).

If you use the ASTCLOCK command without the /R parameter, it simply initializes the PC's date and time by reading that information from the SixPakPremium clock chip, and then "goes away"; no portion of ASTCLOCK remains resident, so you cannot update the date and time information in the clock chip.

## 5.4 The Clock-Calendar Battery

The lithium clock-calendar battery should last for about a year, and is easily replaceable. You can purchase replacement batteries from your AST product dealer. Table 5-1 also lists compatible lithium batteries that are available in camera or department stores.

**Table 5-1. Compatible Clock-Calendar Batteries.**

<b>Manufacturer</b>	<b>Part Number</b>
Duracell	DL2032
General Electric	BR2325
Panasonic	BR2325
Ray-O-Vac	BR2325
Sanyo	CR2032
Varta	CR2032
Radio Shack	CR2320H*

\* Compared to the other batteries listed in this table, the Radio Shack battery is 0.5 millimeters thinner and rated at 50 milliampere-hours less. Its life expectancy is approximately 9 months (compared to a year for the other batteries).



Because the battery is used only when your PC is not operating, the actual life of your battery will be determined by how much the PC is used. The clock chip on your SixPakPremium is powered by the PC system when your PC is on. The battery is used as backup power only while your PC is off.

To replace the battery, slightly lift the retaining clip with your finger (or a small screwdriver) and use another small screwdriver to pry up the silver battery from its holder, then slide it out sideways (Figure 5-2). Do not remove the battery socket from the board.

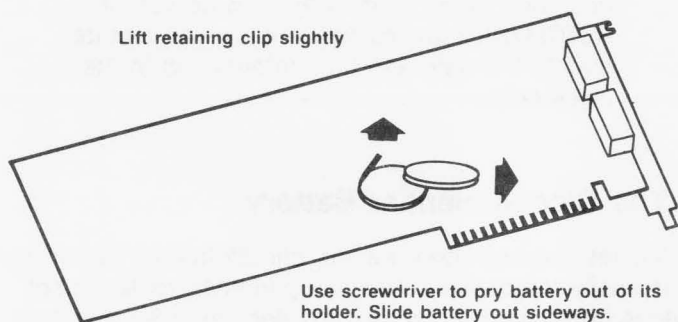

**Figure 5-2. Removing the SixPakPremium Clock-Calendar Battery.**

Take care not to damage or bend the retaining clip by lifting it too far. The clip completes an electrical circuit and must make solid contact with the positive (+) side of the battery. Whenever the battery is removed, it is a good idea to check the clip in the bottom of the battery holder. Be sure that it is sticking up high enough to make good contact with the bottom surface of the battery. When installing a new battery, make sure it is clean and dry.

**NOTE**

If you replace the battery, be sure to use the procedure described in Section 5.3 to restore the proper time and date.

**5.5 Technical Information**

This information is for reference only, and is not necessary to use the clock-calendar feature. The SixPakPremium clock-calendar chip is the RICOH RP5C15, and uses I/O locations 2C0 through 2C7 hex.

**NOTE**

For more information, consult the programming information in the *RICOH RP5C01/RP5C15 Application Manual*. AST Research cannot provide any information other than what is presented here.

(This page intentionally left blank)

## SECTION 6

# SERIAL PORT

SixPakPremium comes standard with one serial port for asynchronous communications, and is available with a second optional serial port. A serial port can connect your PC to a serial printer, modem, or other device which uses an RS-232C interface. The SixPakPremium interface is configured as a Data Terminal Equipment (DTE) device with a male DB9P connector (a nine-pin connector).

This section includes the following information:

- Section 6.1 tells you how to reconfigure the serial ports: changing COM1 to COM2, forcing RS-232C inputs true, disabling the serial ports.
- Section 6.2 discusses serial port programming.
- Section 6.3 gives serial port I/O address assignments and pinouts.
- Section 6.4 discusses serial port diagnostic testing.
- Section 6.5 tells you how to add the optional second serial port to SixPakPremium.

### 6.1 Configuring the Serial Ports

You can install up to two serial ports (called COM1 and COM2) into your PC. The standard SixPakPremium serial port configuration is:

- *First serial port:* Responds as COM1 (which uses IRQ4). (Shorting plugs installed at E3 and E20.)

You can also disable the serial port (remove both shorting plugs) or change it to respond as COM2 (install shorting plugs at E4 and E19).

- *Second serial port (if installed):* Responds as COM2 (which uses IRQ3). Shorting plugs installed at positions E5 (COM2 enable) and E18 (IRQ3 enable).

You must not enable the second serial port if that option is not installed. If both the first and second serial ports are configured as COM2, the first serial port will respond as COM2 and the second serial port will be disabled.

Figure 6-1 illustrates SixPakPremium serial port configuration.

\*First serial port enabled as COM1, using IRQ4:

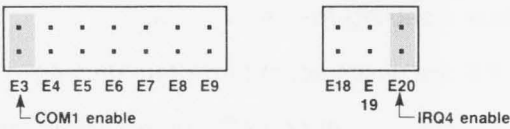

First serial port enabled as COM2, using IRQ3:

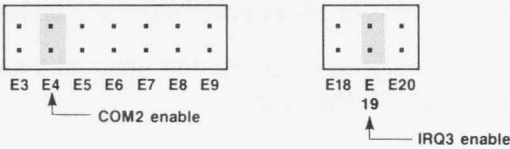

\*Second serial port enabled as COM2, using IRQ3:

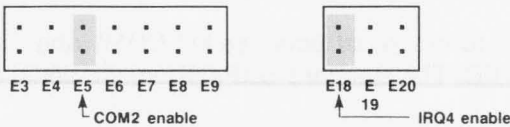

\*Default configuration

**Figure 6-1. Serial Port Configuration.**

### 6.1.1 Installing Multiple Serial Ports in a PC

If your PC already has another card with a serial port on it configured to respond as COM1 (such as the PC-XT with its standard serial board), you must remove or reconfigure one of the devices to avoid a conflict.

Figure 6-1 shows how to change the first serial port on the SixPakPremium to respond as COM2 using IRQ3 as shown in Figure 6-1 (move shorting plugs from jumper positions E3 to E4, and from E20 to E19).

You can only configure the second SixPakPremium serial port (if installed) as COM2. If both the first and second serial ports are configured as COM2, the second serial port will be disabled. To disable the second serial port, remove the shorting plug from positions E3 and E20 (see Figure 6-1). You must disable the second serial port if that option is not installed.

### 6.1.2 Configuring the RS-232C Interface Lines

The SixPakPremium serial ports conform to the Electronic Industries Association (EIA) RS-232C communication standard. Appendix A describes the RS-232C standard in more detail.

*SixPakPremium factory configuration:* In the standard factory (default) configuration, SixPakPremium expects the connected device(s) to drive all input signals to its serial ports.

You do not need to change the SixPakPremium default configuration as long as the the connected device drives these serial port inputs: clear to send (CTS), data set ready (DSR), and data carrier detect (DCD).

*To force certain inputs true:* If your serial device does not drive all SixPakPremium serial port inputs, you can "force true" these three inputs to each serial port: clear to send (CTS), data set ready (DSR), and data carrier detect (DCD).

*First serial port*

CTS input (J2 pin 8)  
 DSR input (J2 pin 6)  
 DCD input (J2 pin 1)

*Second serial port*

CTS input (P2 pin 6)  
 DSR input (P2 pin 2)  
 DCD input (P2 pin 1)

Figure 6-2 shows how to force one or more of the above signals to always be in the true state. Whether certain inputs should be forced true depends on the particular device you connect to the serial port.

**First Serial Port**

**Second Serial Port**

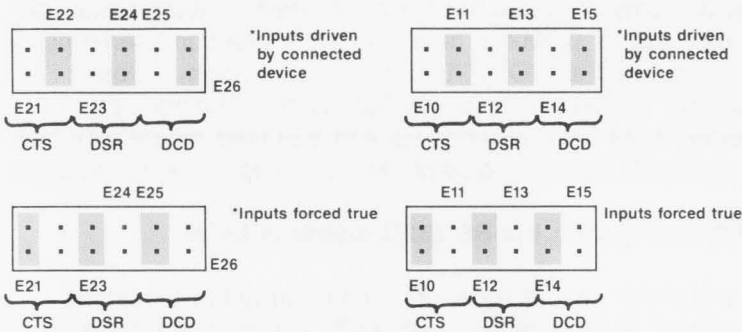

**Figure 6-2. Creating a "Forced True" State.**

You might want to leave the shorting plugs in their "normal" configuration and instead build a special cable for the serial device. This would be especially convenient if you will be using different serial devices on the port at different times. In most cases, you can connect your remote device to the SixPakPremium serial port with a cable provided with the device itself. Simply refer to the instructions provided with the device or with the software for driving it.

In some cases, your instructions will specify how your remote device uses RS-232C line signals and which pin numbers supply which signals. With this information, plus the general information in Appendix A, you can construct an interface cable yourself.

**NOTE**

Serial devices use RS-232C signals in different ways. AST Research cannot tell you how to connect a particular device to your serial port. You must refer to the manufacturer's instructions that came with that device.

SixPakPremium does not support the current loop teletype interface.

**6.1.3 Disabling the Serial Port**

You can completely disable the SixPakPremium serial ports by removing the shorting plugs as shown in Figure 6-1. Be sure to save the shorting plugs for possible future use.

Your PC can have a maximum of two serial ports installed. If there are more than two serial ports, you must disable the extra ports to prevent conflicts between ports.

**6.2 Programming the Serial Port**

The SixPakPremium serial ports are completely under software control, and must be initialized for correct Baud rate, parity, number of databits, and number of stopbits before it can be used. You or your software must initialize the serial ports each time you turn on the computer.

**NOTE**

Using SuperSpool with your serial printer eliminates the need to use the DOS MODE command.

Typically, the DOS MODE command initializes the serial ports (refer to your DOS manual for a detailed explanation of this command). A typical MODE command might look like this:

```
MODE COM1:1200,N,8,1,P <Enter>
```



The above command initializes serial port COM1 for 1200 Baud, no parity, 8 databits, and 1 stopbit. The "P" is optional and tells DOS that you will be using the port with a serial printer. You can also use a similar command to establish communication parameters for serial port COM2.

Many applications programs (such as word processors) automatically handle port initialization, making it unnecessary to use the MODE command. Refer to your software manual; if it does not mention the MODE command, it is probably safe to assume that you can omit that step. If you are unsure, it will not harm anything to go ahead and use the MODE command anyway.

If you are using the serial port to operate a serial printer, you may also need to redirect printer output from LPT1 to COM1 or COM2. This is because DOS always assumes that printer output goes to parallel port LPT1 unless told otherwise. You can use the MODE command to redirect printer output from a parallel port to a serial port. For example:

**MODE LPT1: = COM1: <Enter>** For printer output to COM1

**MODE LPT1: = COM2: <Enter>** For printer output to COM2

A redirection command should follow the first MODE command that sets set up the Baud rate, parity, and so forth. Again, it is possible that your applications program is handling this redirection automatically. If so, you can eliminate this step as well.

### 6.3 Serial I/O Address Assignments and Pinouts

The SixPakPremium serial ports use the system I/O addresses and IRQ interrupt request lines shown in Table 6-1.

**Table 6-1. Serial Port I/O Addresses and IRQs.**

Port Configuration	I/O Addresses	IRQ Line
COM1	3F8-3FF Hex	IRQ4
COM2	2F8-2FF Hex	IRQ3

**NOTE**

The first (standard) SixPakPremium serial port can be configured as COM1 or COM2. The second serial port can be configured as COM2 only. If both the first and second SixPakPremium serial ports are configured as COM2, the second serial port will be disabled.

Figure 6-3 shows the serial port pinouts.

Serial Port

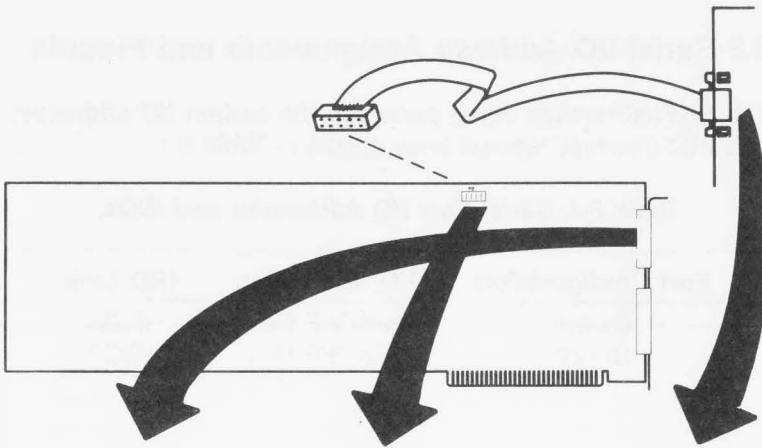

First (standard) Serial Port (DB9P)		Second Serial Port (10-pin stake)		Second Serial Port (DB9P)	
Pin	Signal	Pin	Signal	Pin	Signal
1	DCD (Input)	1	DCD (Input)	1	DCD (Input)
2	RxD (Input)	2	DSR (Input)	2	RxD (Input)
3	TxD (Output)	3	RxD (Input)	3	TxD (Output)
4	DTR (Output)	4	RTS (Output)	4	DTR (Output)
5	Gnd	5	TxD (Output)	5	Gnd
6	DSR (Input)	6	CTS (Input)	6	DSR (Input)
7	RTS (Output)	7	DTR (Output)	7	RTS (Output)
8	CTS (Input)	8	RI (Input)	8	CTS (Input)
9	RI (Input)	9	Gnd	9	RI (Input)
		10	No connection		

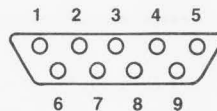
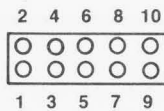
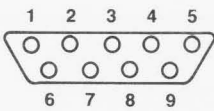

**Figure 6-3. SixPakPremium Serial Port Pinouts.**

You must use a DB9-to-DB25 adapter cable if your serial device uses a DB25 connector. AST offers a DB9-to-DB25 cable (model number ADV-AC) that remaps DB9 serial pinouts (such as from the SixPakPremium serial ports) to the DB25 configuration, as shown in Figure 6-4.

DB9  
Connector

DB25  
Connector

← 1	Carrier Detect DCD	8
← 2	Receive Data RxD	3
← 3	Transmit Data TxD	2
← 4	Data Terminal Ready DTR	20
← 5	Signal Ground GND	7
← 6	Data Set Ready DSR	6
← 7	Request to Send RTS	4
← 8	Clear to Send CTS	5
← 9	Ring Indicator RI	22

**Figure 6-4. DB9-to-DB25 Adapter Cable Pinout.**

Figure 6-5 shows a typical application using the DB9-to-DB25 adapter cable.

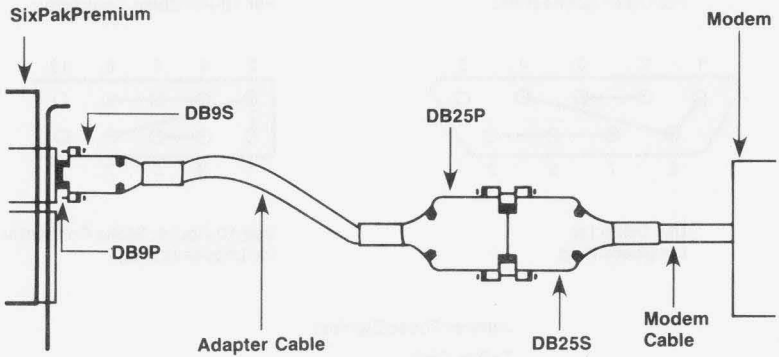

**Figure 6-5. Typical DB9-to-DB25 Cable Application.**

## 6.4 Serial Port Diagnostic Testing

Whenever there is any question about the operation of the SixPakPremium serial port, we recommend that you run the IBM diagnostics, preferably the advanced diagnostics supplied with the IBM *Hardware Maintenance Manual*.

For proper diagnostics operation, disconnect any device connected to the SixPakPremium serial port (such as a modem or serial printer). Also, make sure that the CTS, DSR, and DCD jumpers (Figure 6-2) are in the normal (not "forced true") setting.

You can use a "loopback plug" on the serial port connectors to perform a very thorough test of the serial port with the advanced diagnostics. Figure 6-6 shows the loopback plug configuration for SixPakPremium serial ports.

For DB9P Connectors:

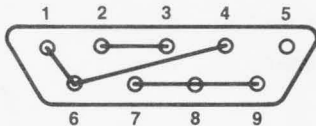

Use DB9S for Loopback Plug

For 10-Pin Stake Connector:

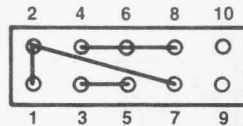

Use 10-Socket Stake Connector for Loopback Plug

Jumper These Signals:  
 TxD to RxD  
 RTS to CTS and RI  
 DTR to DSR and DCD

Figure 6-6. Loopback Plug Configuration.

Answer the Advanced Diagnostics loopback plug question with **Y** when this plug is installed on the serial port connector.

#### **NOTE**

Certain versions of the IBM diagnostics may fail on the first pass. Ignore the results of the first pass if an error occurs.

### **6.5 Adding the Second Serial Port**

AST Research offers an upgrade kit for field installation of the second SixPakPremium serial port. To order the serial port upgrade kit: order model number SPKP-000S through your AST dealer.

The upgrade kit consists of three chips (1488, 1489, and 8250B). To install the second serial port, follow the procedure described below.

#### **CAUTION**

Be sure the power switch is off and the power cord is removed from the system unit. Turn off any other equipment connected to the computer. Installing any component while the power is on can permanently damage your computer and its components.

#### **STEP 1**

*Remove the PC's system unit cover:* Follow the instructions in Section 3.

#### **STEP 2**

*Remove any devices connected to the board:* Remove any serial and/or parallel devices connected to the SixPakPremium board. Also remove the game port ribbon cable (if installed) from the board.

**STEP 3**

*Remove the SixPakPremium board:* Remove the retaining screw from the bracket securing the SixPakPremium board to the PC chassis. With a steady, evenly distributed upward tension, remove the SixPakPremium board from its slot.

**STEP 4**

*Install the second serial port chips:* Your serial port upgrade kit comes with three chips (1488, 1489, and 8250B). Each chip is labelled with a notch or a small dot to identify the bottom left. Insert the chips as shown in Figure 6-7. It is very important that you do not bend any pins when you insert your chips.

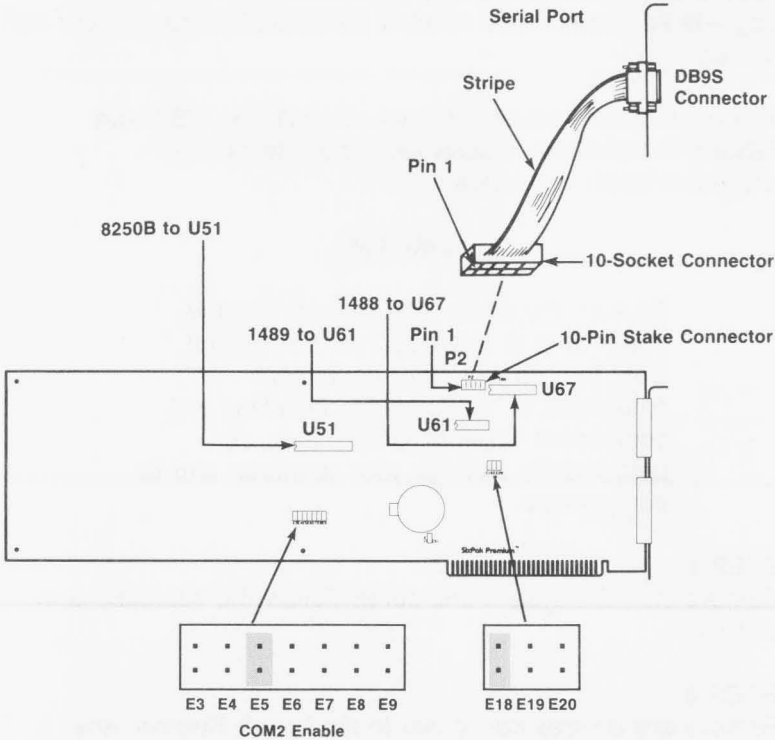

**Figure 6-7. Installing the Second Serial Port Chips.**

**NOTE**

If the chip seems too wide to allow the pins to properly line up with their socket receptacles, place the chip on its side on a flat surface and *gently* angle it under both thumbs to *slightly* bend the pins inward. You may find this same technique useful when actually inserting the chip into the socket on the board. Angle the chip, and slightly insert one row of pins, then bring the other row down into position and slightly start its pins in the socket. Once you have both sides started, you can evenly depress the entire chip until it is firmly seated.

**STEP 5**

*Enable the second port:* Make sure the shorting plugs are installed as shown in Figure 6-7.

**STEP 6**

*Replace the SixPakPremium Board:* Section 3 tells you how to install SixPakPremium into the PC. The second serial port cable plugs onto the 10-pin stake connector (see Figure 6-7).



(This page intentionally left blank)

## SECTION 7

# PARALLEL PRINTER PORT

SixPakPremium comes standard with a parallel port for interfacing the PC to a parallel printer. This port is completely compatible with the IBM PC and uses the same female DB25S connector as an IBM port.

- Section 7.1 tells you how to configure the parallel port.
- Section 7.2 discusses parallel port programming.
- Section 7.3 gives parallel port I/O address assignments and pinouts.
- Section 7.4 discusses parallel port diagnostic testing.
- Section 7.5 tells you how to configure your SixPakPremium to allow interrupt-driven parallel printer software to operate correctly.

Section 3 of this manual tells you how to install the parallel port ribbon cable onto your SixPakPremium board, and how to install the board and the parallel port into your PC.

### 7.1 Configuring the Parallel Port

You can install a maximum of three parallel ports in the IBM PC (called LPT1, LPT2, and LPT3). When looking for parallel ports, the PC polls these I/O addresses in order:

1. 3B0-3BF (display adapters with built-in parallel ports).
2. 378-37F (SixPakPremium LPT1).
3. 278-27F (SixPakPremium LPT2).

## Parallel Printer Port

If there is a parallel port at I/O addresses 3B0-3BF (the address space occupied by display adapters with built-in parallel ports), that port responds as LPT1. A port at 378-37F responds as LPT2, and a port at 278-27F responds as LPT3.

If there is no parallel port at the first I/O address range, the parallel port at the second address responds as LPT1 and the parallel port at the third address responds as LPT2.

The parallel port on the SixPakPremium has been configured at the factory to respond as LPT1 — or LPT2 when a display card with built-in parallel port is present (see Section 7.1.2). You can confirm LPT1 configuration by checking that a shorting plug is installed as shown in Figure 7-1.

\*LPT1 (I/O 378-37F) enabled:

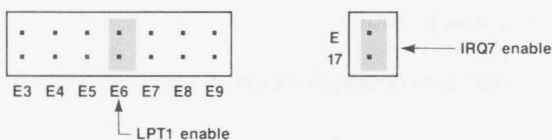

LPT2 (I/O 278-27F) enabled:

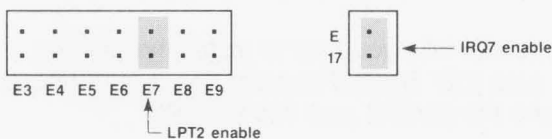

Parallel port disabled:

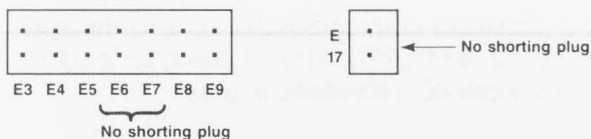

\*Default setting

**Figure 7-1. Parallel Port Configuration.**

### 7.1.1 Installing Multiple Parallel Ports in a PC

If your PC already has another card with a parallel port that occupies the same I/O address range as the SixPakPremium parallel port, you must change one of the devices to avoid conflicts between the two ports. Figure 7-1 shows how to configure SixPakPremium as LPT1 (I/O addresses 378-37F hex) or LPT2 (I/O addresses 278-27F hex).

### 7.1.2 Display Adapters with Built-in Parallel Ports

The built-in parallel port on certain display adapter boards (such as the IBM Monochrome Display/Printer Adapter and the AST Research MonoGraphPlus™ or *Preview!*™) always responds as LPT1 and cannot be changed. If you have such a board in your PC, the SixPakPremium parallel port will automatically respond as LPT2 in its factory default configuration. You do not need to reconfigure the SixPakPremium to respond as LPT2. If you do reconfigure the SixPakPremium for LPT2 when a parallel port that always responds as LPT1 is installed in your PC, the SixPakPremium parallel port will respond as LPT3.

### 7.1.3 Disabling the Parallel Port

You can disable the SixPakPremium parallel port by removing the shorting plug shown in Figure 7-1. You can disable the parallel port to avoid conflicts when you have several parallel adapters installed in your PC. Save the shorting plug for possible future use.

## 7.2 Programming the Parallel Port

The IBM PC always sends printer output to parallel port LPT1 unless specifically told otherwise. Appendix B tells you how you can cause the PC to redirect printer output from LPT1 to LPT2 or LPT3.

Although it is not required, you can use the DOS MODE command to set the line width and the number of lines per page. Refer to your IBM *DOS Manual* for more information.

### 7.3 Parallel Port I/O Addresses and Pinouts

The SixPakPremium parallel port uses the PC I/O addresses listed in Table 7-1.

**Table 7-1. Parallel Port I/O Addresses.**

Port Configuration	I/O Addresses
LPT1*	378-37F hex
LPT2*	278-27F hex

\*When you use a display adapter with a built-in parallel port, DOS sees a SixPakPremium parallel port configured for LPT1 as LPT2, and a SixPakPremium parallel port configured for LPT2 as LPT3.

You can use the standard IBM Parallel Printer Cable to connect the SixPakPremium to an IBM or IBM-compatible printer. You can also use the information in Table 7-2 to help build a cable for your parallel printer.

**Table 7-2. Parallel Port Pinouts.**

<b>Line Name</b>	<b>Output DB25S</b>	<b>AST Adapter Cable IBM Matrix Printer Centronics Interface</b>
-STROBE	1	1
D0	2	2
D1	3	3
D2	4	4
D3	5	5
D4	6	6
D5	7	7
D6	8	8
D7	9	9
-ACK	10	10
BUSY	11	11
PE	12	12
SLCT	13	13
-AUTOFD	14	14
-ERROR	15	32
-INIT	16	31
-SLCT IN	17	36
GROUND	(18-25)	(16,19-30,33)

**NOTE**

A dash in front of the line name denotes lines which are functionally active when low.

## 7.4 Parallel Port Diagnostic Testing

The parallel port on your SixPakPremium is completely compatible with IBM's diagnostics. However, you must configure the parallel port as LPT1 so that the port can be recognized by the diagnostics.

**NOTE**

If there is a display card installed in your PC that always responds as LPT1 (I/O addresses 3B0-3BF hex), the IBM diagnostics cannot recognize the SixPakPremium parallel port.

For proper diagnostics operation, disconnect any device connected to the SixPakPremium parallel port. You can use a loopback plug to perform a very thorough test of the parallel port with the IBM diagnostics. Figure 7-2 shows the loopback plug configuration for the SixPakPremium parallel port.

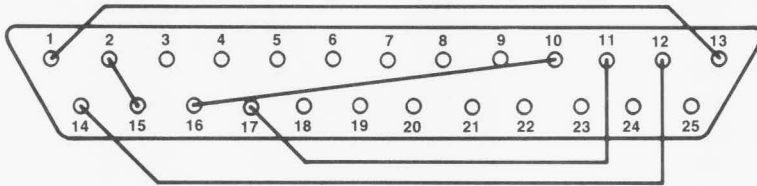

Use DB25P for loopback plug  
Jumper these pins: 1 to 13  
2 to 15  
10 to 16  
11 to 17  
12 to 14

**Figure 7-2. Loopback Plug Configuration.**

**NOTE**

If you run the matrix printer test, your printer must be 100% compatible with an Epson FX-80 or errors can be generated.

## 7.5 Interrupt Driven Parallel Printer Software

Interrupt-driven parallel printer software uses IRQ7. To ensure that your interrupt-driven parallel printer software operates correctly, you must enable IRQ7 on the SixPakPremium board as shown in Figure 7-3. It will not harm anything to enable IRQ7 even if you do not run interrupt-driven software for your parallel printer.

E	■	IRQ7 enabled for parallel port* (shorting plug installed)
17	■	

E	■	IRQ7 disabled for parallel port (no shorting plug installed)
17	■	

\*Default setting

**Figure 7-3. IRQ7 Enabled.**



(This page intentionally left blank)

## SECTION 8

### GAME PORT

The optional game port provides an interface for connecting one or two joysticks to your PC. With appropriate software, the joystick can be used for cursor control, as well as graphics development and interactive games.

This section includes the following:

- Section 8.1 tells you how to enable or disable the game port.
- Section 8.2 discusses software compatibility.
- Section 8.3 gives the I/O address assignment and pinouts for the game port.
- Section 8.4 discusses game port diagnostic testing.
- Section 8.5 tells you how to add the game port to the SixPakPremium.

#### 8.1 Configuring the Game Port

*To enable the game hardware:* The game port ribbon cable must be installed on your SixPakPremium board and the shorting plug must be installed as shown in Figure 8-1.

The game port hardware must be installed on the board (Section 8.5 provides information on adding the port to your SixPakPremium).

## Game Port

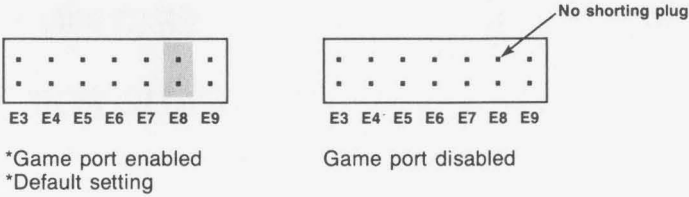

**Figure 8-1. Game Port Enable/Disable.**

*To completely disable the game port:* Remove the jumper shown in Figure 8-1.

## 8.2 Software Compatibility

The game port is totally software-compatible with the IBM game adapter. Because joysticks are analog devices, the function of some software can vary with the joystick used, even though the game port is functioning properly. To compensate for differences between joysticks, use software that includes a joystick-centering function.

You can use the program listing in Section 8.4 to test the correct operation of the SixPakPremium game port.

## 8.3 Game Port Technical Information

This section provides the I/O address assignment and pinouts for the SixPakPremium game port.

### 8.3.1 Game Port I/O Address Assignment

The game port uses I/O address 201 hex. This information is for technical reference only; you do not need to know the I/O address to use the game port.

### 8.3.2 Game Port Pinouts

The SixPakPremium game port cable uses a DB15S (socket or female) connector to enable the connection of up to two joysticks. Table 8-1 summarizes the game port cable connector pinout.

**Table 8-1. SixPakPremium Game Port Pinout.**

SixPakPremium P3 Pin No.	DB15S Pin Number	Signal Name
Joystick A	1	+5VDC
	3	Button 1
	5	X Axis
	7	Ground
	9	Ground
	11	Y Axis
	13	Button 2
	15	+5VDC
Joystick B	2	+5VDC
	4	Button 3
	6	X Axis
	8	Ground
	10	Y Axis
	12	Button 4
	14	+5VDC

You can connect one joystick directly to the DB15S connector. To connect two joysticks, you will need a Y-connector adapter cable. The adapter cable should have one DB15S connector (to the SixPakPremium game port) and two DB15P connectors (to the joysticks). Pins 1 through 8 on the DB15S should connect to one DB15P connector, and pins 9 through 15 to the other, as shown in Figure 8-1. Consult your dealer for further information.

## 8.4 Game Port Diagnostic Testing

You can use the IBM diagnostics to test the SixPakPremium game port. Because of a problem in the diagnostic program, however, the port may not always show up on the listing of installed devices. You might prefer to use the program below to test out the port. This program requires the use of BASICA (not BASIC).

```
10 DEFINT A-Z:KEY OFF:CLS:STRIG ON:SCREEN 2
20 PRINT " X1", " Y1", " X2", " Y2", " S1", " S2", " S3"
30 X1 = STICK(0):Y1 = STICK(1):X2 = STICK(2):Y2 = STICK(3)
40 A = STRIG(1):C = STRIG(5):C = STRIG(3):D = STIG(7)
50 LOCATE 3:PRINT X1,Y1,X2,Y2,A;B;C;D
60 GOTO 30
```

When you run the above program, moving the joystick in the X-plane (left-right) causes a change in the "X1" readout, while moving the joystick in the Y-plane (up-down) causes a change in the "Y1" readout. Pressing the switch (either one or two, depending on your joystick) causes a change in the "S1" or "S3" readouts from 0 to -1. Note that, depending on the quality of your joystick, you may not be able to get a zero reading in the X and Y planes when running the program. This is normal and no cause for alarm.

## 8.5 Adding the Game Port to Your SixPakPremium

AST Research offers an upgrade kit for field installation of the SixPakPremium game port. To order the game port upgrade kit: order model number SPKP-000G through your AST dealer. The upgrade kit consists of a 16-pin chip and 20-pin chip. To install the game port, follow the procedure described below.

**CAUTION**

Be sure the power switch is off and the power cord is removed from the system unit. Turn off any other equipment connected to the computer. Installing any component while the power is on can permanently damage your computer and its components.

**STEP 1**

*Remove the PC's system unit cover:* Follow the instructions in Section 3.

**STEP 2**

*Remove any devices connected to the board:* Remove any serial and/or parallel devices connected to the SixPakPremium board. Also remove the second serial port ribbon cable (if installed) from the board.

**STEP 3**

*Remove the SixPakPremium board:* Remove the retaining screw from the bracket securing the SixPakPremium board to the PC chassis. With a steady, evenly distributed upward tension, remove the SixPakPremium board from its slot.

**STEP 4**

*Install the game port chips:* Your game port upgrade kit comes with two chips: a 16- and 20-pin chip. Each chip is labelled with a notch or a small dot to identify the bottom left. Insert the chips as shown in Figure 8-2. It is very important that you do not bend any pins when you insert your chips.

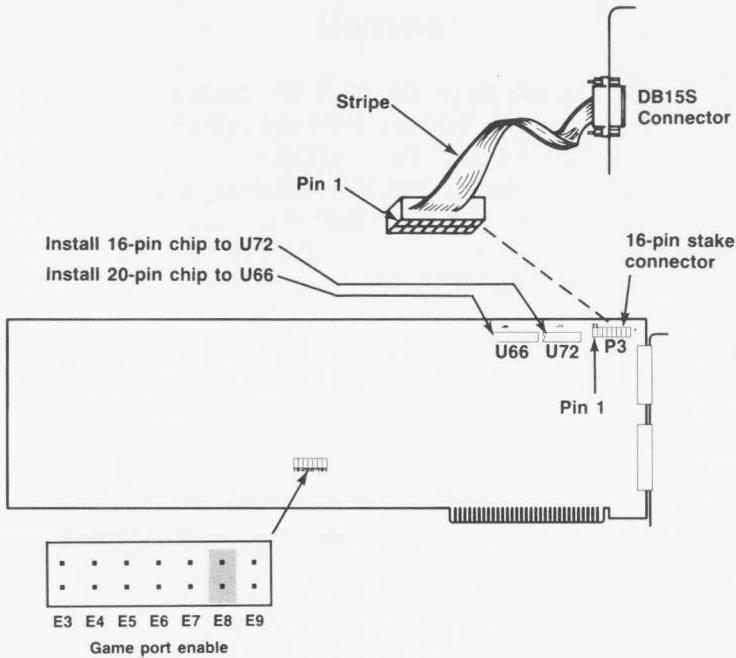

**Figure 8-2. Installing the Game Port Chips.**

**NOTE**

If the chip seems too wide to allow the pins to properly line up with their socket receptacles, place the chip on its side on a flat surface and *gently* angle it under both thumbs to *slightly* bend the pins inward. You may find this same technique useful when actually inserting the chip into the socket on the board. Angle the chip, and slightly insert one row of pins, then bring the other row down into position and slightly start its pins in the socket. Once you have both sides started, you can evenly depress the entire chip until it is firmly seated.

**STEP 5**

*Enable the game port:* Make sure the shorting plug is installed as shown in Figure 8-2.

**STEP 6**

*Replace the SixPakPremium Board:* Section 3 tells you how to install SixPakPremium into the PC. The game port cable plugs onto the 16-pin stake connector (see Figure 8-2).



(This page intentionally left blank)

## SECTION 9

### MEMORY CONFIGURATION

This section tells you how to install additional memory on SixPakPremium and Premium-Pak.

Section 3 of this manual tells you how to configure SixPakPremium (for starting memory address, conventional memory size, and parity error checking enable/disable) before installing it into your PC.

If your SixPakPremium or Premium-Pak is not fully populated — if less than 1 megabyte (MB) of memory is installed on either board — you can plug in 256-kilobyte (KB) random access memory (RAM) chips to upgrade memory. You can remove SixPakPremium memory simply by unplugging RAM chips. Figure 9-1 shows which memory banks must be populated for each SixPakPremium memory size.

*Rules for adding or subtracting memory:*

- For each memory size, all specified rows of chips must be populated entirely with 256-KB chips (150 nanosecond (ns) or faster, such as 120 ns, access time).
- You must add or subtract SixPakPremium memory in 256-KB increments — possible memory capacities for the SixPakPremium board only (not including Premium-Pak) are 256 KB, 512 KB, 768 KB, and 1 MB. Possible memory capacities for SixPakPremium plus Premium-Pak are 1.25, 1.5, 1.75, and 2 MB.
- Whenever you add or remove memory, be sure to reset the dual in-line package (DIP) switches if the memory configuration changes (including the starting memory or conventional memory size parameters).

Memory Configuration

- You must run the INSTALL program whenever you add or remove SixPakPremium memory. Section 4 tells you how to run the INSTALL program.

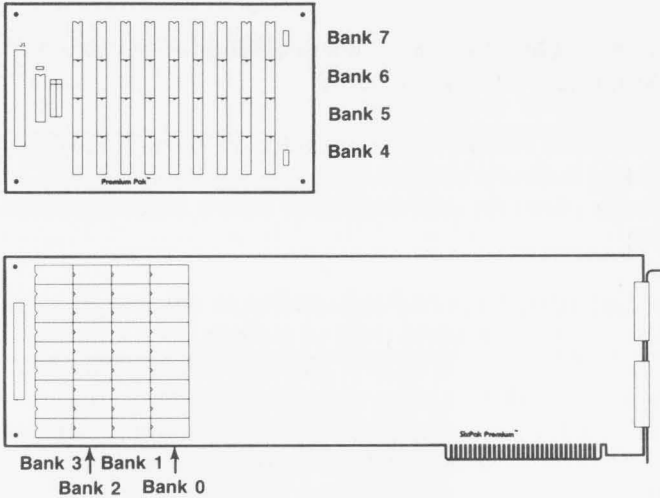

If SixPakPremium memory size is:	These memory banks must be fully populated:
256 KB	0
512 KB	0, 1
768 KB	0, 1, 2
1 MB	0, 1, 2, 3
1.25 MB	0, 1, 2, 3, 4
1.5 MB	0, 1, 2, 3, 4, 5
1.75 MB	0, 1, 2, 3, 4, 5, 6
2 MB	0, 1, 2, 3, 4, 5, 6, 7

Figure 9-1. SixPakPremium and Premium-Pak Memory Configuration.

## APPENDIX A

### SERIAL INTERFACES

This appendix provides general information on wiring the SixPakPremium serial port to other serial devices (such as printers, plotters, or modems), including:

- The RS-232C serial interface standard (Section A.1).
- Interfacing DTE to DCE (Section A.2).
- Interfacing DTE to DTE — “null modem” (Section A.3).
- Designing your own serial interface (Section A.4).

The SixPakPremium serial port is completely IBM-compatible. In most cases, you can connect your remote device to the SixPakPremium serial port with a cable provided with the device itself. Simply refer to the instructions provided with the device or with the software for driving it.

In some cases, your instructions will specify how your remote device uses RS-232C line signals and which pin numbers supply which signals. With this information, plus the information in this appendix, you can construct an interface cable yourself.

#### NOTE

Serial devices use RS-232C signals in different ways. AST Research cannot tell you how to connect a particular device to your serial port. You must refer to the manufacturer's instructions that came with that device.

The SixPakPremium serial port does not support the current loop teletype interface.

## A.1 RS-232C Interface Standard

SixPakPremium connects to other serial devices according to the Electronic Industry Association (EIA) RS-232C interface standard.

The RS-232C standard describes the sequence of signals that travel between two serial devices. The signals control the exchange of data between serial devices. RS-232C defines 21 signals (although few applications use all 21), and each signal travels separately on a predefined wire.

The RS-232C standard classifies communications devices as:

- *Data terminal equipment (DTE)*: Equipment associated with the user, such as a PC or a mainframe computer. The SixPakPremium serial port is a DTE device.
- *Data communications equipment (DCE)*: Equipment associated with transmission facilities, such as a modem.

The RS-232C standard describes the ideal case, where a DTE device connects to a DCE device. Before sending data, the SixPakPremium serial port must send and receive RS-232C signals in this order:

1. Some DCE devices use the Ring Indicator (RI) signal to alert SixPakPremium that incoming data is due.
2. SixPakPremium sends Data Terminal Ready (DTR) to signal a request for a communications link.
3. SixPakPremium receives Data Carrier Detect (DCD) and Data Set Ready (DSR) — these signals indicate that the DCE is ready.
4. SixPakPremium sends Ready to Send (RTS) — this signal tells the DCE that SixPakPremium is ready to send data.

5. SixPakPremium receives Clear to Send (CTS) — a signal from the DCE to go ahead and transmit data.
6. SixPakPremium then starts transmitting data via the Transfer Data (TxD) signal. SixPakPremium receives data via the Receive Data (RxD) signal.

To prevent damage to either device, the ground signals must always be connected.

You can think of certain pins on one side of the interface as “functional pairs”:

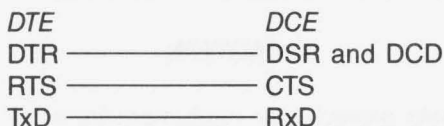

## A.2 Interfacing DTE to DCE

An example of a DTE-to-DCE interface that conforms to the RS-232C standard would be to connect the SixPakPremium serial port (DTE) to a telephone modem (DCE). A correctly configured DCE/DTE interface is wired straight across: DTE pin 4 wired to DCE pin 4, pin 2 to pin 2, and so forth.

Two serial devices interact in a certain sequence — called “handshaking” — to function properly:

1. Some modems (DCE) has an automatic answer mode that uses the signal RI to alert the DTE that incoming data is due. SixPakPremium (the DTE) would then use DTR to respond to RI.
2. When the SixPakPremium serial port (DTE) wants to send or receive data it raises the voltage on the pin that carries the DTR (Data Terminal Ready) signal. This voltage travels to the DCE where the modem interprets it to mean that a communications link is being requested by the DTE device.

3. If an open phone line exists, the DCE brings up two lines on its side of the interface: DSR and DCD.
4. When the DTE sees high voltage at its DSR and DCD inputs, it can then bring up RTS. RTS tells the DCE that the DTE has data to transmit to it.
5. The DCE checks that it is ready to receive data; if so, it brings up CTS.
6. Once the DTE sees voltage at CTS, it can transmit data on the wire connected to TxD — or it can receive data via RxD (Receive Data).

### CAUTION

To help protect your equipment from damage, be sure to connect the ground wires between the SixPakPremium serial ports and your external serial devices.

Figure A-1 shows an ideal DTE to DCE interface, including signals, signal directions, and sequence (top to bottom). The interface must handle these signals before the DTE can transmit or receive data:

- DCD, DSR, CTS, and RxD are input signals to the SixPakPremium.
- DTR and RTS are output signals from the SixPakPremium.

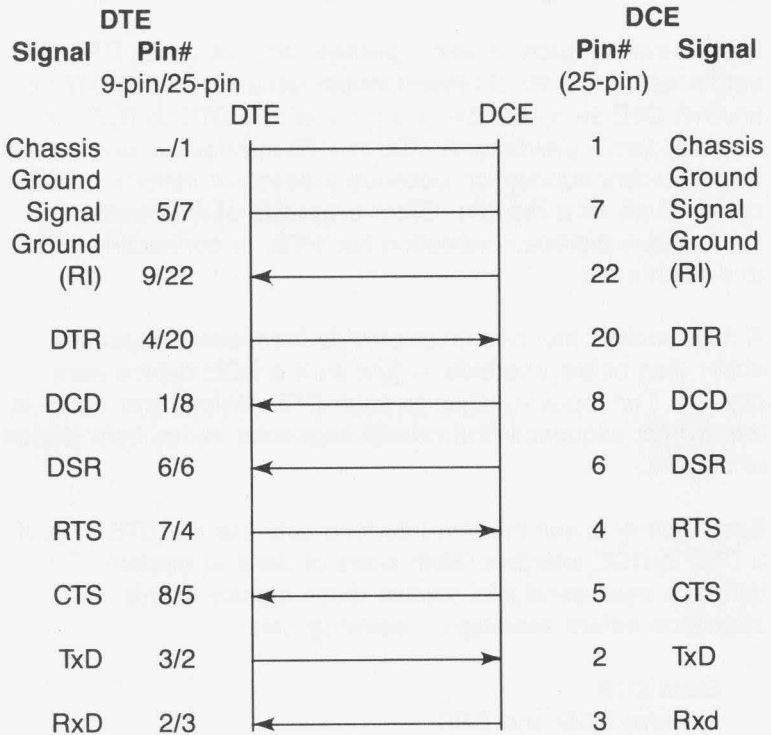

**Figure A-1. DTE-to-DCE Interface.**

Figure A-1 shows the interface signals in order of occurrence (top to bottom). From the DTE's standpoint, it must send DTR, see DCD, see DSR, send RTS, and see CTS before transmitting or receiving data.

The DTE inputs must have voltage applied to them for the interface to become operational (the DTE outputs are necessary only because they are inputs to the DCE side of the interface). The DTE hardware does not release data to the communications link until it has received the proper set and sequence of signals.



### A.3 Interfacing DTE to DTE (“Null Modem”)

Many devices (such as serial printers) are set up as DTE. To output data from the SixPakPremium serial port (also DTE) to another DTE serial device, you must wire a DTE to DTE (or “null modem”) interface. A DTE to DTE interface is also called a *null modem* connection because it does not include a DCE device such as a modem. Other examples of null modem connections include connecting two PCs, or connecting a PC to a mainframe.

A null modem interface must provide “response” inputs to either side of the interface — just as if a DCE device were present. The input voltages to each DTE device must occur in the correct sequence (the correct sequence varies from device to device).

Each side of a null modem interface acts like the DTE side of a DTE to DCE interface. Both sides of the null modem interface must send and receive these signals in this sequence before sending or receiving data:

- Send DTR
- Receive DCD and DSR
- Send RTS
- Receive CTS

Figure A-2 shows a standard null modem configuration, including signal directions and sequence.

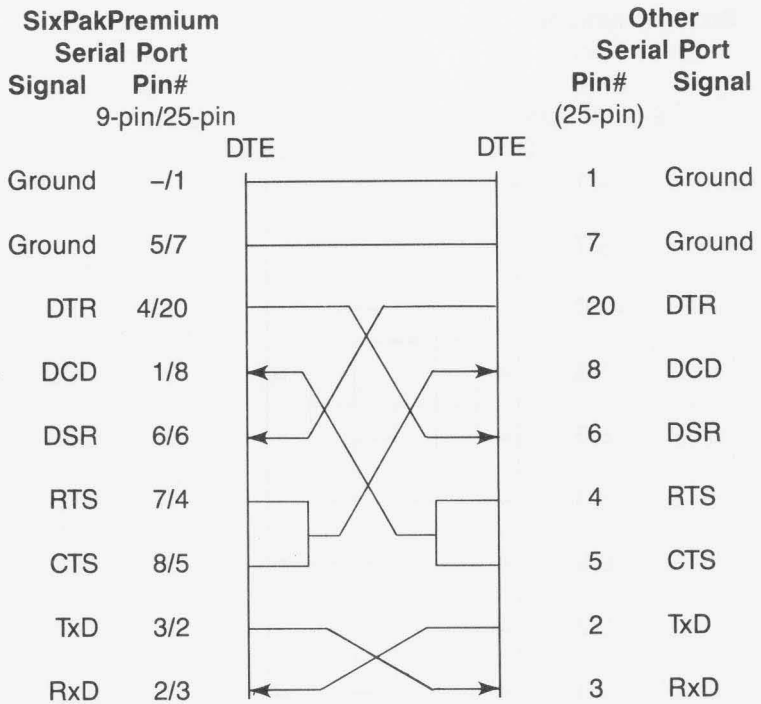

**Figure A-2. Example #1: Null Modem (DTE-to-DTE) Interface.**

Figure A-3 illustrates another null modem interface, including the direction and sequence of the signals.

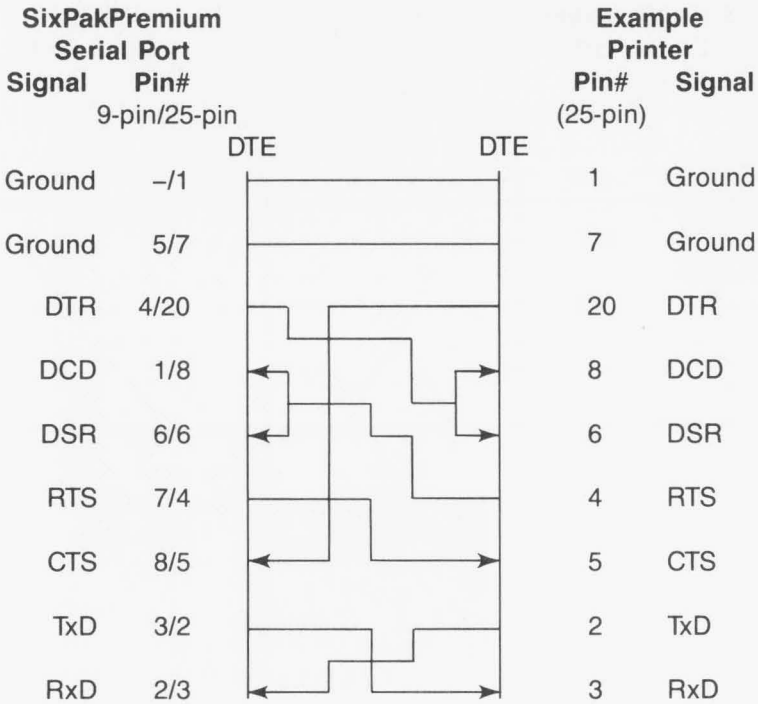

**Figure A-3. Example #2: Null Modem Interface.**

Notice that the necessary input signals are supplied to both sides. DCD, DSR, and CTS have voltage applied to them on either side.

The example shown in Figure A-3 changes the ideal sequence by having the printer DTR signal drive PC signal CTS. The chip that controls the SixPakPremium serial port (an 8250 UART chip) is fairly flexible in reading the sequence of inputs.

The input sequence in Figure A-3 is changed because the printer in the example drops its DTR signal when its receive buffer is about to fill up. To avoid losing data when the printer's

receive buffer overflows, the interface halts PC data output immediately by dropping the CTS input to the PC side immediately. The remainder of the interface then "idles" until the printer raises DTR again. Remember that this is a specific case for this particular printer.

Figure A-4 shows another example of how to interface a serial printer to a SixPakPremium serial port.

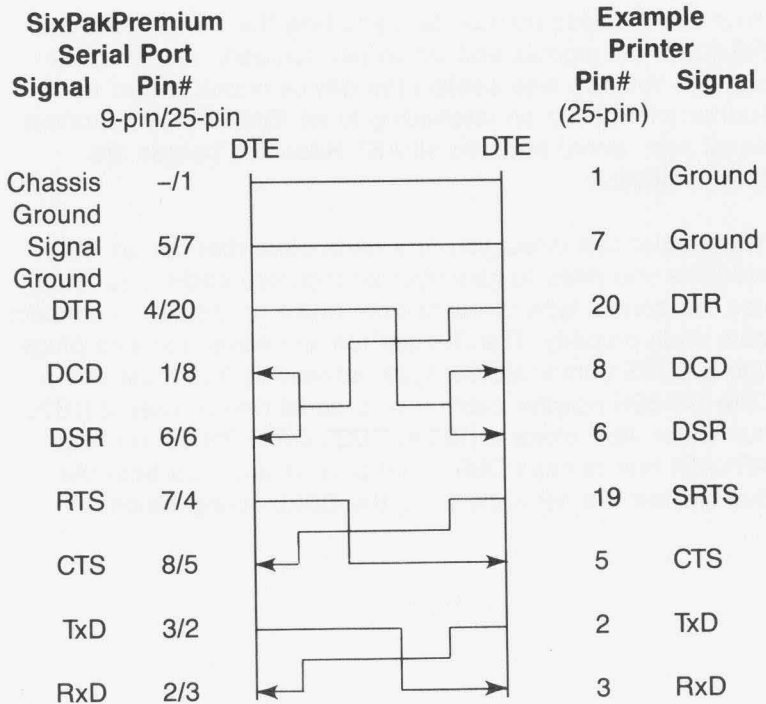

**Figure A-4. Example #3: Null Modem Interface.**

In this case, the printer uses SRTS (Secondary Request to Send, pin 19) instead of pin 4 (RTS); apart from that exception, Figure A-3 follows the ideal DTE input and sequence rules.

The advantage of the interface shown in Figure A-4 is that every pin is driven by its functional counterpart on the other side of the interface; the functionally related signal pairs include DTR/DSR, RTS/CTS, and TxD/RxD. This should also hold true for the interface you design.

## A.4 Design Aids

Your serial device manual tells you how the device uses the RS-232C line signals and which pin numbers supply which signals. You can also contact the device manufacturer for further information on interfacing to an IBM PC asynchronous serial port. Serial ports on all AST Research boards are IBM-compatible.

Your dealer can direct you to a parts store that carries the products you need to construct an interface cable. You must use the correct type of connectors (male or female) to connect both ends properly. The SixPakPremium serial port end plugs into a DB9S (female/socket type) connector. You must use a DB9-to-DB25 adapter cable if your serial device uses a DB25 connector. AST offers a DB9-to-DB25 cable (model number ADV-AC) that remaps DB9 serial pinouts (such as from the SixPakPremium serial ports) to the DB25 configuration.

To wire your serial interface signals properly, we suggest you use the form shown in Figure A-5 as a design aid.

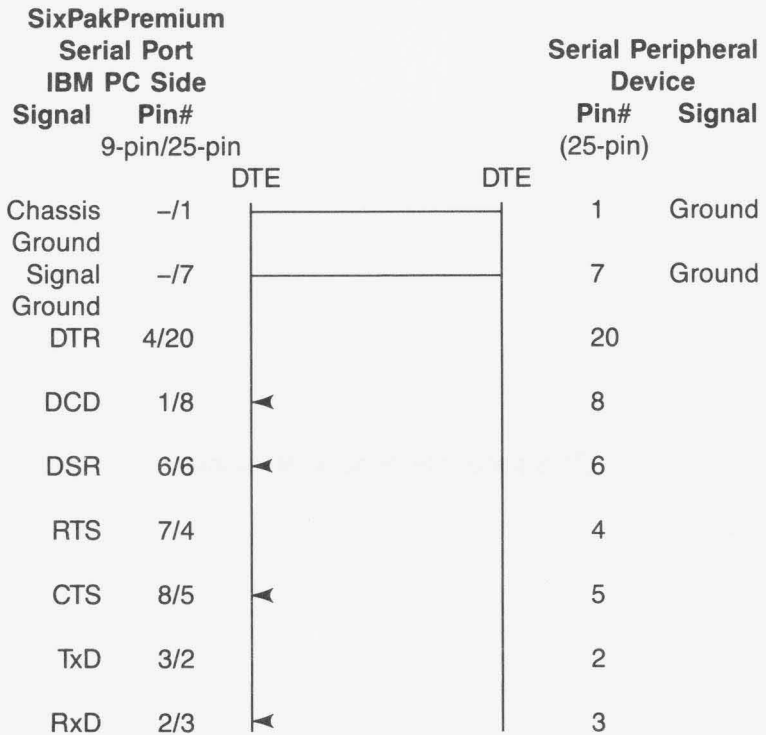

**Figure A-5. Serial Interface Form.**

If you plan to use several different serial devices on your serial port, you can make a separate interface assembly for each device. That way you can use the same long cable to connect your PC to any of these devices.

(This page intentionally left blank)

## APPENDIX B

# SWITCHING BETWEEN PARALLEL PRINTER PORTS

This appendix gives you programs you can use in a batch file to direct printer output normally designated for the device attached to port LPT1, to instead be routed to the device attached to port LPT2 or LPT3. (The program also directs output, normally designated for the device attached to port LPT2 or LPT3, to instead be routed to the device attached to port LPT1.) For more information on creating a batch file, see your *IBM DOS Manual*.

The programs in this appendix are particularly useful if your applications program (a word processing program, for example) is capable of sending print output to only one parallel port. You might also use this program when your LPT1 printer (call it printer #1) is down for service, or when you want to take advantage of the type style or speed of the printer attached to LPT2 or LPT3 (call it printer #2 or #3). This program allows you to quickly switch between outputs without having to alter your hardware interface or change each line in programs where LPT1, LPT2, or LPT3 appear as your output port designation.

If your printers are not configured to the same parameters, as defined in the DOS MODE command, you must add two MODE statements when switching devices.

Notice that the "swap" program below is written in BASIC. Since the printer port swap is best handled in DOS, BASIC is invoked within the .BAT file. No RUN command is required when the BASIC call and the program file name occur on the same line (**BASIC LPTSWAP**). Consult your *IBM BASIC Manual* if you have any questions about entering and saving the LPTSWAP.BAS program.



## B.1 Switching Between LPT1 and LPT2

The following DOS batch file and BASIC program will redirect printer output from LPT1 to LPT2 or vice versa, depending on which port is being used at the time.

LPTSWAP.BAT (or a name of your choosing) with the following:

```
MODE LPT1:[parameters for printer #2 (if needed)]
MODE LPT2:[parameters for printer #1 (if needed)]
BASIC LPTSWAP
```

LPTSWAP is a BASIC program, as shown below. The comments are included for clarification and need not be included in the actual program

```
10 DEF SEG=&H40           ' finds port address table
20 A=PEEK (8): B=PEEK (9) ' save LPT1 address
30 POKE 8,PEEK (10): POKE 9,PEEK (11) ' LPT2 address to LPT1
40 POKE 10,A: POKE 11,B   ' LPT1 address to LPT2
50 SYSTEM                 ' return to DOS
```

Omit statement 50 if you will be LPRINTing from BASIC.

## B.2 Restoring LPT1 to LPT1 and LPT2 to LPT2

Use the same program, LPTSWAP, to restore your parallel printer ports to their original arrangement. Be sure to restore the proper parameters using a new batch file and MODE statements.

LPTRSTR.BAT is as follows:

```
MODE LPT1:[parameters for printer #1 (if needed)]
MODE LPT2:[parameters for printer #2 (if needed)]
BASIC LPTSWAP
```

### B.3 Switching Between LPT1 and LPT3

The following DOS batch file and BASIC program will redirect printer output from LPT1 to LPT3 or vice versa, depending on which port is being used at the time.

LPTSWAP.BAT (or a name of your choosing) with the following:

```

MODE LPT1:[parameters for printer #3 (if needed)]
MODE LPT3:[parameters for printer #1 (if needed)]
BASIC LPTSWAP

```

LPTSWAP is a BASIC program, as shown below. The comments are included for clarification and need not be included in the actual program:

```

10 DEF SEG = &H40           ' finds port address table
20 A = PEEK (8): B = PEEK (9) ' save LPT1 address
30 POKE 8,PEEK (12): POKE 9,PEEK (13) ' LPT3 address to LPT1
40 POKE 12,A: POKE 13,B    ' LPT1 address to LPT3
50 SYSTEM                  ' return to DOS

```

Omit statement 50 if you will be LPRINTing from BASIC.

### B.4 Restoring LPT1 to LPT1 and LPT3 to LPT3

Use the same program, LPTSWAP, to restore your parallel printer ports to their original arrangement. Be sure to restore the proper parameters using a new batch file and MODE statements.

LPTRSTR.BAT is as follows:

```

MODE LPT1:[parameters for printer #1 (if needed)]
MODE LPT3:[parameters for printer #3 (if needed)]
BASIC LPTSWAP

```

(This page intentionally left blank)

## APPENDIX C

### HOW SIXPAKPREMIUM WORKS

This appendix gives a brief overview of how SixPakPremium works, including memory paging and descriptions of AST expanded memory software modules (REMM.SYS and REX.SYS), and how to modify them if necessary. Although you do not need this information to use SixPakPremium, it is provided for those who want some background on how the product functions.

#### NOTE

Important! To use expanded memory, your boot disk *must* contain REMM.SYS. REX.SYS is required to run RAM disks and print spoolers from expanded memory.

#### C.1 Memory Paging

By using a technique called *memory paging*, SixPakPremium allows your PC to use *expanded memory* — memory beyond the normal PC memory map.

The IBM PC can address up to one megabyte (MB) of memory. The normal memory map (shown Figure C-1) allocates the first 640 kilobytes (KB) of PC memory as user memory. Some of the PC memory between 640 KB and 1 MB is used for such purposes as video RAM and ROM to support PC housekeeping functions —but there are large unused areas.

Each SixPakPremium board can contain up to 2 MB of physical memory (when Premium-Pak is installed). SixPakPremium physical memory is divided into 16-KB blocks called *pages*. SixPakPremium software (along with your expanded memory

applications software) swaps memory pages in and out of open *windows* in the area between 640 KB and 1 MB. To further enhance performance, the AST expanded memory manager can also take advantage of any unused memory *below* 640 KB. This process — memory paging — allows your PC to access up to 2 MB SixPakPremium physical memory at RAM speeds, completely transparent to the user.

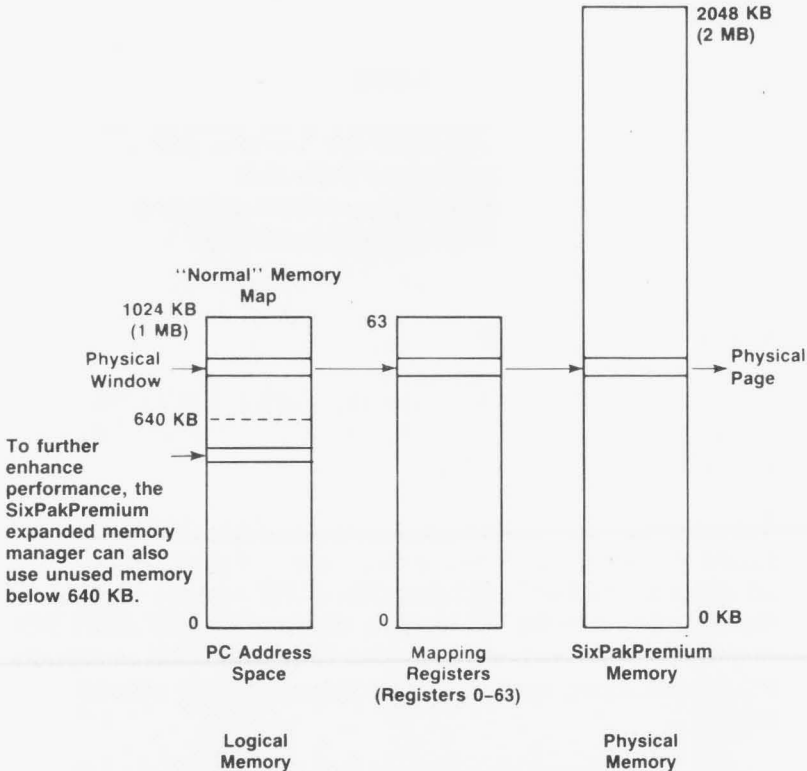

Figure C-1. Paging Technique.

## C.2 Expanded Memory Manager — REMM.SYS

The REMM software driver swaps memory between the SixPakPremium board and PC memory by creating pointers, loading the registers, and mapping PC windows to SixPakPremium expanded memory.

Your applications program must keep track of what page of SixPakPremium memory holds a particular element of data, in order to retrieve it. According to parameters supplied by the applications program, REMM links windows in logical PC memory to pages of SixPakPremium physical memory by means of the 64 Mapping registers, the Map Control register and the Page registers.

REMM also allocates SixPakPremium memory to several *Process IDs* (also known as *expanded memory manager (EMM) handles*). Each Process ID is allocated to a particular applications program, and has certain pages of memory allocated to it. Process IDs aid in multitasking.

Before memory mapping is enabled, REMM automatically maps any of the 16-KB pages that are to fill out the 640 KB on the PC. You can circumvent this automatic allocation by setting SixPakPremium switches to indicate that 640 KB is already installed in the PC. Using the INSTALL program to select the AST memory manager installs REMM.SYS and automatically configures it for your system.

## C.3 Extended Memory Emulator — REX.SYS

REX interfaces with the REMM program to make SixPakPremium expanded memory act like PC-AT extended memory. This allows you to use AST's fASTdisk, SuperDrive, and SuperSpool (also IBM's DOS 3.x VDISK.SYS utility with the "E" option) to create large RAM disks in SixPakPremium expanded memory.

REX intercepts calls on read-only memory basic input/output system (ROM BIOS) functions designed for extended memory use, and interfaces them to the REMM software so that they can use SixPakPremium expanded memory.

*REX must be installed after the REMM software, and it cannot function without REMM software. REX must be installed if you plan to operate SuperDrive or SuperSpool from extended memory, or if you want to use the VDISK.SYS "/E" option (which uses extended memory).* The SuperPak INSTALL program automatically installs REX (if needed) configured for your system.

As with applications that use the REMM software, program code portions of the SuperPak programs must reside in the 640 KB of PC memory. However, data associated with SuperPak utilities, however, can use SixPakPremium expanded memory.

## **C.4 Modifying REMM and REX**

As installed with AST's SuperPak INSTALL program, REMM and REX should not require further modification. However, the information in this section is provided as a reference for programmers.

You can add these statements to your CONFIG.SYS file to change the default REMM and REX software drivers:

**DEVICE = REMM.SYS [/X] [/P] [/S] [/D] [/C]**

and/or

**DEVICE = REX.SYS [nnnn]**

This section describes the parameters you can use with each of these statements.

### **C.4.1 DEVICE = REMM.SYS Parameters**

You can append multiple parameters to the DEVICE = REMM statement. Separate parameters with one blank space. This section describes the following REMM parameters:

**DEVICE = REMM.SYS [/X] [/P] [/S] [/D] [/C]**

With the exception of the “/X” parameter, the following are intended for software developer use.

### **/X = — Exclude**

The /X parameter allows you to exclude certain ranges of memory from REMM mapping. REMM will never map into memory space that is already occupied, but you may have an application for which you would like to reserve certain memory ranges.

### **NOTE**

If you will be using software designed for the enhanced expanded memory specification (EEMS), AST recommends excluding the area used by video memory (generally in the B000-BFFF range) from mapping. The INSTALL program automatically installs the appropriate “/X” parameter.

Format: **/X = nnnn-nnnn**

where *n* is a hexadecimal digit. The first *nnnn* is the starting address of the range, and the second *nnnn* is the ending address.

You can specify multiple ranges as long as you separate each address range with one blank.

Default: None excluded.

Example: **DEVICE = REMM.SYS /X = B000-BFFF**

This is the standard statement for a system that includes a Hercules graphics adapter.

Example: **DEVICE = REMM.SYS /X = C140-CA00 /X = DDDD-DDFF**



Notes: You must leave at least one contiguous 64-KB segment of memory available for mapping by REMM starting in the range C000 through E000. In other words, you may not use the */X* parameter to exclude all contiguous 64-KB segments that start in that range.

***/PIDS =* or */P =* — Process IDs**

The */P* parameter limits the number of process IDs that REMM will allow. A *process ID* is the identification assigned to each user or application on the system.

Format: ***/PIDS = n* or */P = n*** (short form)

where *n* is a decimal number from 2 to 256.

Default: The default value is 32.

Example: **DEVICE = REMM.SYS /PIDS = 12**

Notes: Increasing the number of process IDs increases the amount of memory used by REMM.

***/START =* or */S =* — Start**

The */S* parameter tells REMM to put logical page 0 of the mapping window at the specified segment address. This hexadecimal address must be on a 16-KB boundary, and must be within the range C000 through E000.

Format: ***/START = nnnn***

where *n* is a hexadecimal digit.

Default: Determined dynamically by REMM.

Example: **DEVICE = REMM.SYS /START = C000**

**/DEPTH = or /D = — Depth**

The /D parameter specifies the maximum number of mapping register contexts per process ID that REMM can save. Refer to the *RAMpage! Technical Reference Manual* for a more detailed description of this parameter. Unless you are developing software, the default value should be adequate.

Format: **/DEPTH = nn**  
where *nn* is any decimal number from 1 to 32.

Default: The default value is 5.

Example: **DEVICE = REMM.SYS /DEPTH = 15**

**/CONTEXTS = or /C = — Total Contexts**

The /C parameter specifies the total number of mapping register contexts that can be saved for all process IDs combined. Unless you are developing software, the default value should be adequate.

Format: **/CONTEXTS = nnn**  
where *n* is a decimal digit.

Default: The value of DEPTH plus the value of PIDS minus one.

Example: **DEVICE = REMM.SYS /CONTEXTS = 36**

Notes: The value of CONTEXTS cannot be less than the value of PIDS.

#### C.4.2 DEVICE = REX.SYS Parameters

The AST SuperPak INSTALL program automatically configures and installs the appropriate command statement for REX.

Format: **DEVICE = REX.SYS [nnnn]**

where *nnnn* is a decimal number indicating the amount of memory (in KB) allocated for use by REX.

Default: The default value is 512 (KB).

Example: **DEVICE = REX.SYS 1024**

Notes: The amount of memory allocated to REX must be at least as much as the sum of all extended memory used by fASTdisk, SuperDrive, SuperSpool, IBM's VDISK, and any other RAM disks and print spoolers set up to use memory outside the 0- to 640-KB area. If you do not express this value as a multiple of 16 KB, it will automatically be rounded up to the next highest multiple.

#### C.4.3 Modifying CONFIG.SYS for fASTdisk

If you intend to use fASTdisk for virtual disk software, be sure to add the appropriate statement to your CONFIG.SYS file as described in your IBM *SuperPak User's Manual*. The **DEVICE = FASTDISK.SYS** statement must follow the **REMM** and **REX** statements in the CONFIG.SYS file to enable fASTdisk to use SixPakPremium memory.

## APPENDIX D

# TROUBLESHOOTING

This section outlines some simple procedures for troubleshooting if you have a problem with your SixPakPremium. It also tells you how to return your SixPakPremium to the factory should it require repairs.

### D.1 Solving Common Problems

The following outlines some suggestions for solving common problems with the SixPakPremium.

**PROBLEM:** Parallel port doesn't work.

**ACTION:** Check the following:

- The device connected to the port works and is powered on.
- Cable connections are secure. Check the cables between the parallel port and peripheral device. Also check that the parallel port ribbon cable connector is securely attached to the SixPakPremium board.
- The software you are using is sending output to the correct device. SixPakPremium is usually configured so that the parallel port responds as LPT1 (unless you changed the default configuration or a display adapter with a built-in parallel port is installed in your PC — see Section 7). Check your software to see to which device it is sending output.
- Make sure the parallel port and IRQ 7 are enabled. Go over the procedures in Section 7 to make certain the port is configured properly.

**PROBLEM:** Serial port doesn't work.

**ACTION:** Check the following:

- The device connected to the serial port is powered on and working.
- Cable connections are secure. Check the cabling between the serial port and the peripheral device (Appendix A provides general serial port cabling information). Also check that the ribbon cable to the serial port connector is securely attached to the SixPakPremium board.
- The software you are using is sending output to the correct device. If you are using a serial printer, you may need to direct printer output from LPT1 to COM1 or COM2 (see Section 6).
- The serial port(s) is configured properly. In its default configuration, the first SixPakPremium serial port is configured as COM1 (using IRQ4), and the second serial port (if installed) is configured as COM2 (using IRQ3). Unless configured otherwise, both ports expect the connected device to drive all serial inputs.

Section 6 shows the default configuration and tells you how to change it.

- The serial port is correctly initialized (Section 6). Check that the Baud rate, parity, number of data bits, and number of stop bits for the peripheral device match what you specified in your DOS MODE command, or what your software specified for you.

**PROBLEM:** Game port doesn't work.

**ACTION:** Check the following:

- The device connected to the game port is powered on and working.
- Cabling is secure. Check the cabling between the game port and the peripheral device. Also check that the ribbon cable to the game port connector is securely attached to the SixPakPremium board.
- The game port is installed and enabled as described in Section 8. If you installed the game port option yourself, recheck the procedure described in Section 8.

**PROBLEM:** Memory errors.

**ACTION:** Check the following:

- The SixPakPremium memory parameters (including starting memory address, parity checking, conventional memory size, and Dual Page mode), which are described in detail in Section 3.6.
- The Premium-Pak piggyback board (if installed) is installed properly, as described in Section 3.2.
- The PC system board switches are set properly, as described in Section 3.3.

**PROBLEM:** DOS or ASTCLOCK displays incorrect time or date.

**ACTION:** Use the procedure described in Section 5.3 to set the correct time and date. If resetting the time and date does not fix the problem, replace the clock-calendar battery as described in Section 5.4.

## D.2 Product Repair Procedure

If your AST Research product ever requires repair, contact your dealer first. The dealer from whom you originally purchased the product can usually service the product. If you must return a hardware product to the factory for service, follow these guidelines to ensure rapid, accurate turnaround:

1. *Call AST Research Technical Support for a Return Authorization Number (RAN):* A technician will discuss the problem with you; if factory service is required, the technician will give you a Return Authorization Number (RAN). Always refer to the RAN when you return anything for service. AST Research will return anything without a RAN to the sender.
2. *If the product is covered under an AST Research Warranty:* There is no charge for parts or labor involved in the repair. Please include a copy of your original purchase receipt as the proof of date of purchase for all warranty repairs.
3. *If the product is not covered under a warranty:* Contact your dealer or AST Research Technical Support for instructions on obtaining service for your product.
4. *Parts not covered under the warranty:* Dealer- or user-installed parts (such as RAM chips) are not covered under the terms of the warranty. Dealer- installed parts are warranted by the dealer; parts that you install are covered only by the parts suppliers' warranties. If we find that your dealer- or user-installed parts are defective, we can identify which parts are defective, but we will not replace parts unless you specifically authorize us to do so in writing when you send the board to us. The parts charges and any applicable labor charges will be billed COD.

5. *Describe the problem and return any related accessories:* Please include a brief but explicit written description of the problem when you return your AST product to the factory for repair. Also return any accessories that might relate to the problem. For example, if the the parallel port does not function correctly, be sure to return the parallel port adapter cable with the board.
  
6. *Be sure to provide a return shipping address that UPS can deliver to and include your RAN:* UPS cannot normally deliver to post office boxes. Reference the RAN issued to you by AST Technical Support on all correspondence. Securely package all materials to prevent shipping damage. Shipping charges must be prepaid; CODs will not be accepted. Ship the materials to the following address:

AST Research, Inc.  
Customer Service—RAN xxxx  
2722 Michelson  
Irvine, CA 92715

where xxxx is your assigned Return Authorization Number.

7. Once your product is repaired, we will return it to you by UPS or UPS Blue Label service, whichever is appropriate for your geographical location. We will return items covered by warranty at our expense. Shipping costs and repair expenses for items not covered by warranty will be billed COD. If you prefer overnight service (UPS Red Label), the shipping charges will be billed COD. If you want us to ship Federal Express, please give us your Federal Express account number for billing purposes.



(This page intentionally left blank)

## LIMITED WARRANTY

AST Research, Inc. warrants to the original purchaser of this AST Research, Inc. product that it is to be in good working order for a period of two years from the date of purchase from AST Research, Inc. or an authorized AST Research, Inc. dealer. Should this product, in AST Research, Inc.'s opinion, malfunction during the warranty period, AST will, at its option, repair or replace it at no charge, provided that the product has not been subjected to misuse, abuse, or non-AST authorized alterations, modifications, and/or repairs.

Products requiring Limited Warranty service during the warranty period should be delivered to AST with proof of purchase. If the delivery is by mail, you agree to insure the product or assume the risk of loss or damage in transit. You also agree to prepay shipping charges to AST.

ALL EXPRESS AND IMPLIED WARRANTIES FOR THIS PRODUCT INCLUDING, BUT NOT LIMITED TO, THE WARRANTIES OF MERCHANTABILITY AND FITNESS FOR A PARTICULAR PURPOSE, ARE LIMITED IN DURATION TO THE ABOVE TWO-YEAR PERIOD. Some states do not allow limitations on how long an implied warranty lasts, so the above limitations may not apply to you.

UNDER NO CIRCUMSTANCES WILL AST RESEARCH, INC. BE LIABLE IN ANY WAY TO THE USER FOR DAMAGES, INCLUDING ANY LOST PROFITS, LOST SAVINGS, OR OTHER INCIDENTAL OR CONSEQUENTIAL DAMAGES ARISING OUT OF THE USE OF, OR INABILITY TO USE, SUCH PRODUCT. Some states do not allow the exclusion or limitation of incidental or consequential damages for consumer products, so the above limitations or exclusion may not apply to you.

THIS WARRANTY GIVES YOU SPECIFIC LEGAL RIGHTS, AND YOU MAY ALSO HAVE OTHER RIGHTS WHICH MAY VARY FROM STATE TO STATE.

The limited warranty applies to hardware products only.

**AST RESEARCH, INC.**

**Product Comment Form**

**SixPakPremium  
User's Manual  
000334-001 C**

We appreciate your comments regarding any problems or suggestions related to AST Research products. Please use this form to communicate any observations that you have concerning the improvement of either the product itself or the product documentation provided in this manual.

**Submitter Information**

Submitter's name:

Address:

**Product/Manual Comments and Suggestions**

Please mail this form to:

**AST Research, Inc.  
Attn: Product Marketing  
2121 Alton Ave.  
Irvine, CA 92714**

