



Full color and monochrome laser quality printer.

SJ-144MC

Users Manual

Federal Communications Commission Radio Frequency Interference Statement

This equipment has been tested and found to comply with the limits for a Class B digital device, pursuant to Part 15 of FCC Rules. These limits are designed to provide reasonable protection against harmful interference in a residential installation. This equipment generates, uses and can radiate radio frequency energy and, if not installed and used in accordance with the instructions, may cause harmful interference to radio communications. However, there is no guarantee that interference will not occur in a particular installation. If this equipment does cause harmful interference to radio or television reception, which can be determined by turning the equipment off and on, the user is encouraged to try to correct the interference by one or more of the following measures.

- Reorient or relocate the receiving antenna.
- Increase the separation between the equipment and receiver.
- Connect the equipment into an outlet on a circuit different from that to which the receiver is connected.
- Consult the dealer or an experienced radio/TV technician for help.

Unauthorized modifications of this product by the user will void his authority to operate the equipment unless expressly approved by the party responsible for compliance.

For compliance with the Federal Noise Interference Standard, this equipment requires a shielded cable.

The above statement applies only to printers marketed in the U.S.A.

Statement of The Canadian Department of Communications Radio Interference Regulations

This digital apparatus does not exceed the Class B limits for radio noise emissions from digital apparatus set out in the Radio Interference Regulations of the Canadian Department of Communications.

Le présent appareil numérique n'émet pas de bruits radioélectriques dépassant les limites applicables aux appareils numériques de la classe B prescrites dans le Règlement sur le brouillage radioélectrique édicté par le ministre des Communications du Canada.

The above statement applies only to printers marketed in Canada.

VDE Statement

This device carries the VDE RFI protection mark to certify that it meets the radio interference requirements of the Postal Ordinance No. 243/1991. The additional marking "Vfg.243/P" expresses in short form that this is a peripheral device (not operable alone) which only individually meets the Class B RFI requirements in accordance with the DIN VDE 0878 part 3/11.89 and the Postal Ordinance 243/1991.

If this device is operated in conjunction with other devices within a set-up, in order to take advantage of a "General (Operating) Authorization" in accordance with the Postal Ordinance 243/1991, the complete set-up must comply with the Class B limits in accordance with the DIN VDE 0878 part 3/11.89, as well as satisfy the preconditions in accordance with § 21 and the prerequisites in accordance with § 3 of the Postal Ordinance 243/1991.

As a rule, this is only fulfilled when the device is operated in a set-up which has been type-tested and provided with a VDE RFI protection mark with the additional marking "Vfg 243".

Machine Noise Information Ordinance 3. GSGV, January 18, 1991: The sound pressure level at the operator position is equal or less than 70 dB (A) according to ISO 7779.

The above statement applies only to printers marketed in Germany.

Trademark Acknowledgements

SJ-144MC SJ-144: Star Micronics Co., Ltd.

Macintosh, ColorSync, TrueType fonts and QuickDraw: Apple Computer, Inc.

Xerox 4024: Xerox Corporation

Hammermill LaserPrint: International Paper Company

Notice

- All rights reserved. Reproduction of any part of this manual in any form whatsoever without STAR's express permission is forbidden.
- The contents of this manual are subject to change without notice.
- All efforts have been made to ensure the accuracy of the contents of this manual at the time of press. However, should any errors be detected, STAR would greatly appreciate being informed of them.
- The above notwithstanding, STAR can assume no responsibility for any errors in this manual.

Introduction

Thank you for purchasing the SJ-144MC Laser-Quality Printer. This User's Manual has been organized into six chapters and an index to help you learn the proper operation of your printer. All explanations regarding operation conform to standard Macintosh GUI operation. The six chapters explain the basic functions and operation of the printer. The following describes the contents of each chapter.

The minimum system requirements for the SJ-144MC are:

- System 6.05 or later, Color QuickDraw and 2MB of RAM
or
- System 7.x, Color QuickDraw and 4MB of RAM

Note: Adding more RAM will enhance printing performance

Chapter 1 Setting up your printer

This chapter details the proper way to set up your printer. It includes how to plug in the AC adapter and interface connector to your computer and the installation of the paper support and ribbon cassette.

Chapter 2 Paper handling

This chapter explains the paper limits for printing and the three paper paths and their restrictions.

Chapter 3 Installing the printer driver and TrueType fonts

This chapter takes you step-by-step through each of the procedures to install the printer driver and the TrueType fonts.

Chapter 4 Printing

This chapter explains the various dialog boxes which appear on your screen and how to use the settings to create the exact color and monochrome you want.

Chapter 5 Maintenance and troubleshooting

This chapter provides brief checklists on several areas of the printer functions. It also includes information on routine cleaning. Please note that this chapter is not intended to be an exhaustive service manual. Should you be unsure of your ability to perform any maintenance or servicing, call a qualified service technician.

Chapter 6 Reference information

This chapter lists the printer's specifications and customer service phone numbers.

Index

This lists, in alphabetical order, terms which appear in this manual.

Features of the printer

This printer is capable of many useful and high quality printing functions ranging from color printing to overhead projection (OHP) film and strip label printing.

The main features of this printer are:

- The ability to print sharp, crisp laser-quality text and graphics.
- The ability to print vibrant, glossy full color documents from a palette of up to 256 colors (depending on your software).
- High speed throughput due to Star's unique 2.5 line 144 element multi-line print head.
- 360 DPI for high resolution graphics output.
- Small, compact size.
- Color, overhead projection (OHP) film and label printing capabilities are standard.
- Three paper feed paths which include the standard paper tray and front and rear feeding.
- The newly developed thin ribbon process allows you to produce more documents.
- TrueType fonts disk containing 35 scalable fonts for all Macintosh application software.

Printer components

This page shows and explains various printer components.

Front Cover

This covers the internal workings of the printer. This cover should be closed at all times, unless cleaning the printer, removing paper jams or changing ribbons.

Ribbon carriage

This carries the ribbon across the print area. Never push or pull on it directly with your hands.

Friction rollers

These pull paper through the print area.

Paper tray lever

This releases pressure on the paper. This lever must be forward to release paper and back to feed paper.

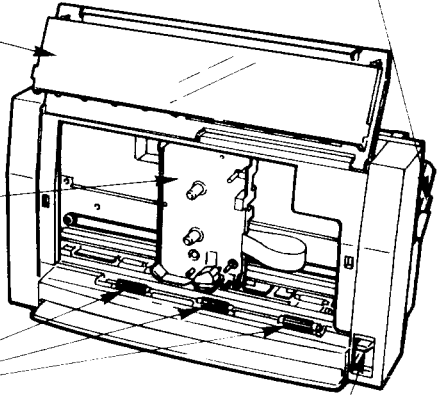

Paper release lever

This releases pressure on the paper. This lever must be down to feed paper and up to release paper.

Control panel

This indicates the status of the printer and makes control over the printer's various functions easy and convenient.

Print density dial

This changes the print density. It is set at 100% in the factory set-up.

Power switch

This turns power to the printer ON and OFF.

AC adapter cable connector

This connects the plug of the AC adapter. Do not remove the plug when the printer is on.

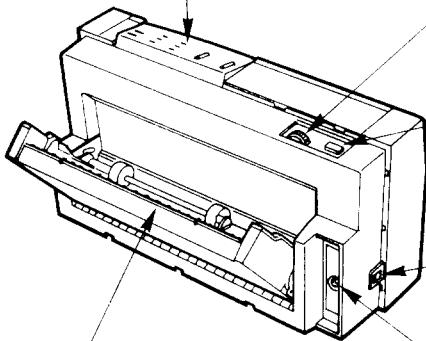

Paper tray

The paper tray can hold up to 30 sheets of paper for automatic paper feed.

Interface connector

This connects the computer to the printer.

	Introduction	
	Features of the printer	
	Printer components	
	Chapter 1 Setting up your printer	1
	Unpacking and confirming the package contents	1
	Placing the printer	1
	Connecting the printer to your computer	2
	Plugging in the AC adapter	2
	Installing the ribbon cassette	3
	Installing the paper support	5
	Chapter 2 Paper handling	7
	Selecting paper types	7
	Loading paper from the paper tray	8
	Loading paper from the rear path	9
	Loading paper from the front path	10
	Clearing paper jams	11
Contents	Chapter 3 Installing the printer driver and TrueType fonts	13
	Minimum system requirements	13
	Checking the system software	13
	Installing the printer driver	14
	Installing the TrueType fonts	15
	Getting Started	16
	Scalable TrueType Font Samples	16
	Chapter 4 Printing	17
	Key and lamp explanation	17
	PAPER	17
	READY	17
	Conditions indicated by the lamps	18
	Key operations	18
	Paper feed	18
	Top of form	18
	Line feed	19
	Paper eject	19
	Test mode	19

Page Setup	20
Media	20
Size	20
Custom...	21
Strip Labels	21
Reduce or enlarge	22
Orientation	22
Layout	22
Options	22
Flip Horizontal	23
Flip Vertical	23
Invert Image	23
Color Correction	23
Paper Feed Adjustment	24
Separations	24
OK/Cancel	24
Printing documents	25
Copies	25
Page Range	25
Resolution	26
Dithering	26
Print As: Colors	26
Print As: Grays	27
Print	27
Help	27
About	27
Using the other printing functions	28
Printing with color ribbons	28
Printing with overhead projection (OHP) film	28
Printing with strip labels	28
Printing with iron-on transfer sheets	30
Chapter 5 Maintenance and troubleshooting	33
Requirements	33
Cleaning the printer	34
Cleaning dirt from the printer	34

Cleaning the print head	34
Cleaning the platen	35
Cleaning friction rollers	35
Troubleshooting	36
Power supply	37
Printing	37
Paper feeding	39
Chapter 6 Reference information	41
Specifications	41
Printer supply options	43
Pin-out of interface connector	45
Index	47
Customer service information	49
Customer response	50

Chapter 1 Setting up your printer

Your printer is a reliable and quality precision instrument. It is every owner's responsibility to make sure that their equipment is properly placed and sensibly used. If the following conditions are met, you can expect your printer to perform at its finest and to last a long time.

Unpacking and confirming the package contents

When you open the box, you will find the following items included. Remove all of the packing materials, such as the cardboard piece to stabilize the ribbon carriage inside the printer cover, etc. Check to make sure, when removing the contents of the carton, that each item has been included. There should be a total of seven items. If you are missing any of them, contact your dealer immediately.

Items:

- | | |
|---------------------------------|-------------------------|
| 1 SJ-144MC printer | 2 Black ribbon cassette |
| 3 Color ribbon cassette | 4 1 AC adapter |
| 5 U-shaped paper support | 6 User's Manual |
| 7 Printer and font driver disks | |

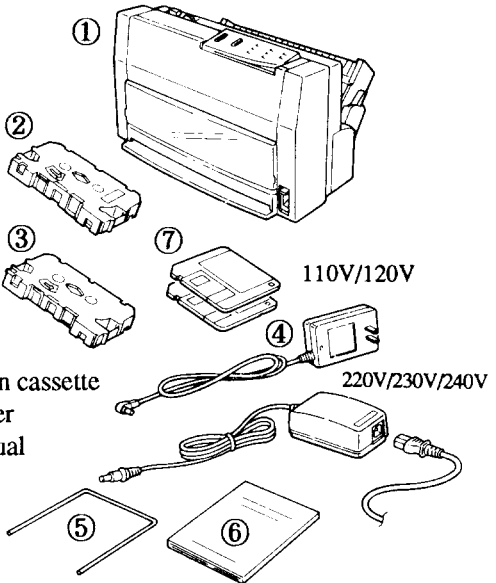

We recommend that you save the box and all of the packing materials for this printer. They are useful should you ever need to transport it to a new location.

Warning: Never push or pull on the ribbon carriage with your hands.

Placing the printer

For prolonged and proper use, your printer should be placed and used in an area which meets the following conditions.

- A firm, level surface which is free from vibration.
- An area free from excessive heat such as direct sunlight or heaters.
- A dust free environment.
- A steady power supply. Do not connect it to items which use the same circuit as refrigerators or air conditioners.
- Use only the line voltage that is specified on the identification plate.
- The printer should be positioned relatively close to the computer. The maximum recommended length of the serial interface cable (not supplied) is 7 meters or 23 feet.

Connecting the printer to your computer

Please use an Apple system peripheral 8-pin cable (Serial number M-0197) or compatible cable (not supplied).

Steps:

1. Make sure that the power to the printer and computer are turned OFF.
2. Insert one end of the interface cable (not supplied) to the connector on the printer. Make sure that the connector fit is snug.
3. Connect the other end of the interface cable to the computer. Refer to your Macintosh User's Guide for installation.

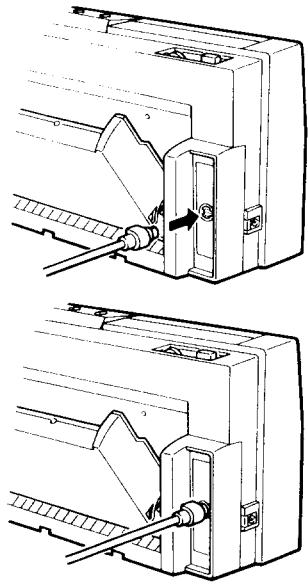

Note: This printer does not support the AppleTalk network interface. Therefore, you cannot connect more than one Macintosh computer to share the printer with other people. This printer will not operate if it is connected to a Macintosh using either a LocalTalk cable or connector box.

Plugging in the AC adapter

Warning: Use only the AC adapter included with this printer. Using a different adapter could result in damage to the printer or personal injury.

The power button is located on the top left hand side of the printer. When it is protruding outward, the printer is OFF. When the button is pressed inward, the printer is ON and the power lamp will be lit. Make certain that this printer button is turned OFF before plugging in the AC adapter.

Steps for 110V/120V AC adapter:

1. Confirm that the power button is in the OFF position.
2. Insert the AC adapter into the socket located on the printer's lower left side.
3. Plug the AC adapter into a properly grounded AC outlet.

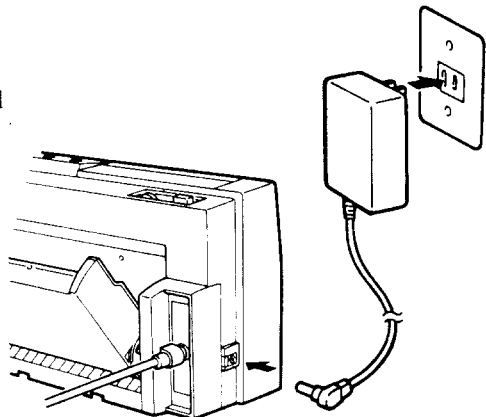

Steps for 220V/230V/240V AC adapter:

1. Confirm that the power button is in the OFF position.
2. Plug the AC cord into the AC adapter.
3. Insert the AC adapter into the socket located on the printer's lower left side.
4. Plug the AC cord into a properly grounded AC outlet.

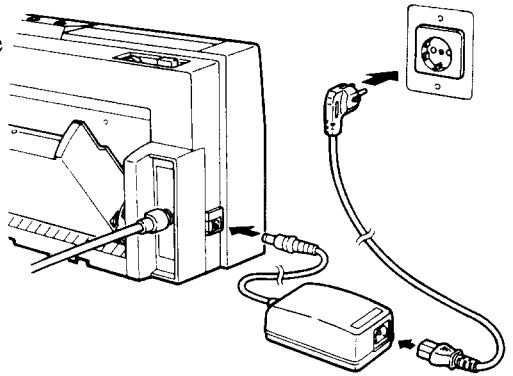

Installing the ribbon cassette

Steps:

1. Turn ON power to the printer. Confirm that the printer is in the Not Ready mode. The **Ready** lamp should not be lit. If the **Ready** lamp is lit, the printer is in the Ready mode. Press the **Ready** key to enter the Not Ready mode. The carriage will move automatically to the center of the printing area. Keep the cover closed when turning ON the printer.
2. Remove the accessory ribbon cassette from its box. Hold it vertically between your thumb and index and middle fingers so that the name seal is upright and is facing you. Turn the ribbon tension knob in the direction of the arrow to take up any slack in the ribbon.

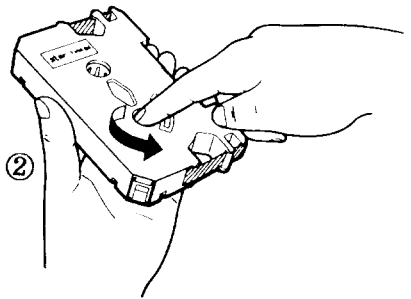
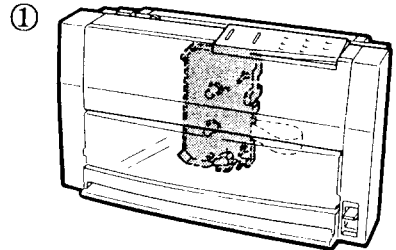

3. Open the front cover of the printer. Fold the cover in half when opening.

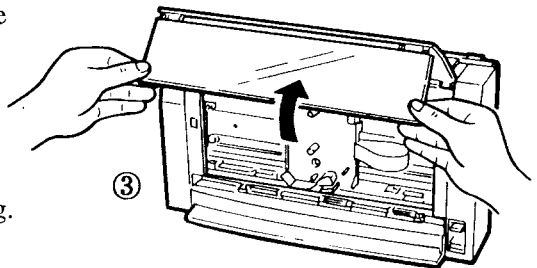

Warning: Never put your fingers into the printer when turning the power ON because the ribbon carriage moves automatically to the center when the power is turned ON.

4. Insert the ribbon cassette so that its holes fit onto the four spindles. The ribbon, itself, should be between the print head and the platen. When the ribbon is properly in place, the appropriate ribbon lamp will light. (ie: COLOR/OHP/LABEL)

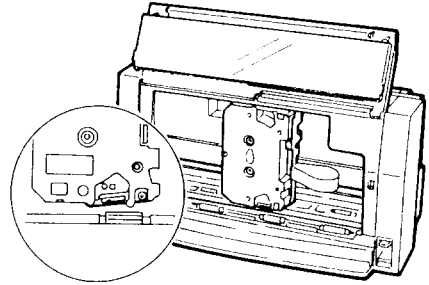
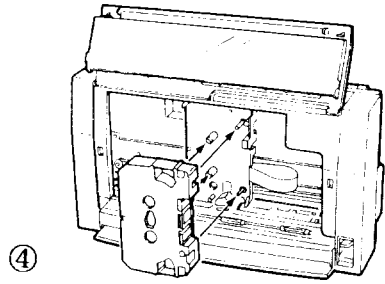

5. Close the cover of the printer. Press the **Ready** key to enter to the Ready mode. The **Ready** lamp will illuminate.

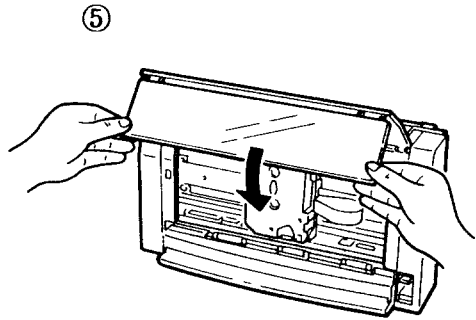

Note: Installments of OHP film, strip labels and iron-on transfer ribbon cassettes are the same. However, please read "Chapter 4 Printing" which includes explanations of printing with OHP film, strip labels and iron-on transfer sheets.

Note: This ribbon has been created using a new technology which allows it to be almost half of the thickness of current ribbons. Take special care not to tear or damage the ribbon when installing or changing ribbons. Do not use the ribbon more than once.

Installing the paper support

The ends of the U-shaped paper support fit into the holes located in the top of the paper tray. Using the paper support will keep your paper from falling out of the paper tray and it will help prevent paper jams.

Step:

Insert the ends of the U-shaped paper support all the way into the two holes on the top of the paper tray.

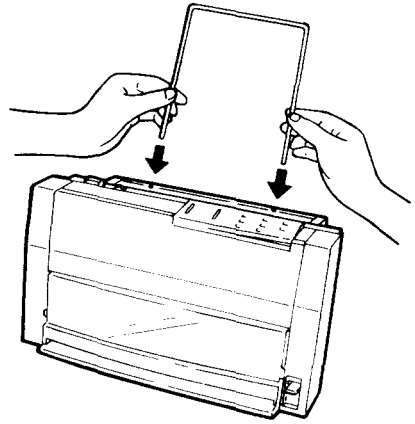

Warning: Never place your fingers into the internal workings of the printer.

Setting the print density

This printer uses a heat fusion process for printing onto a wide variety of print media. You can change the density of the final print by using the density dial located on the top left hand side of the printer, next to the power switch. This dial is set to the full density position when shipped. You can lower the density by rotating the dial in the counter-clockwise direction.

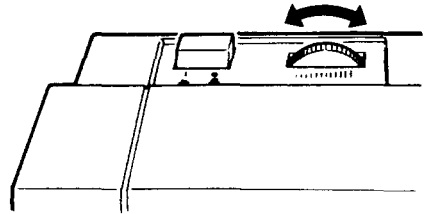

Chapter 2 Paper handling

Your printer has three different printing paths from which you can select to meet your specific printing requirements. This printer can handle different sizes and types of printing media, but we suggest that you read this chapter which explains the recommended types and sizes you can use.

Selecting paper types

Use only good quality paper equivalent to Xerox #4024 or Hammermill's LaserPrint #10460-4 for all three feed paths. Use the following information to determine the size of paper you can use.

- Width: 100.0 - 242.0mm/
3.94 - 9.53 in.
- Length: 100.0 - 355.6mm/
3.94 - 14.0 in.
- Thickness: 0.06 - 0.10mm (0.00236 - 0.00394 in.) for the paper tray and front path 0.06 to 0.23mm (0.00236 - 0.00906 in.) for the rear path
- Surface: Xerography - quality sheet paper or smoother such as Xerox #4024 or Hammermill's LaserPrint #10460-4. Laser-quality overhead projection (OHP) film, post cards, iron-on transfer sheets and strip labels can also be used.

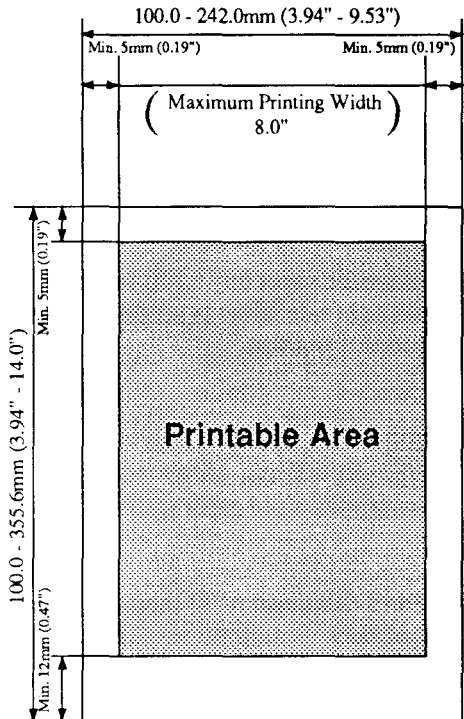

Caution: Do not use paper thicker than that indicated in this manual. Do not use perforated or stapled paper, nor paper attached with paper clips. Always use the appropriate ribbon and paper path for either overhead projection (OHP) film, iron-on transfer or strip label printing when using these features.

Loading paper from the paper tray

The convenient paper tray can load and print up to 30 sheets of paper at a time. With this paper feeding method, you can print both color graphics and text. You can use paper widths of 100.0 to 242.0mm (3.94 - 9.53in.) and lengths of 100.0 to 355.6mm (3.94 - 14.0 in.). It can also handle paper thicknesses of 0.06 to 0.10mm (0.00236 - 0.00394 in.).

Steps:

Make certain that the power is OFF.

1. Recline the paper tray on the back of the printer.
2. Move the paper tray lever, located on the right side of the paper tray, to the forward position.
3. Adjust the paper guides to the paper size you will use. Never move the inner, card sized paper guide.
4. Fan a maximum of 30 sheets of paper and stack them in the paper tray. Move the paper tray lever to the rear position.
5. Move the paper release lever, located on the front side of the printer, to the lower position.
6. Turn ON the printer's power. Paper will feed when the print command is given.

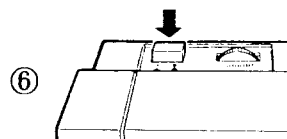
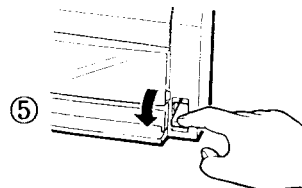
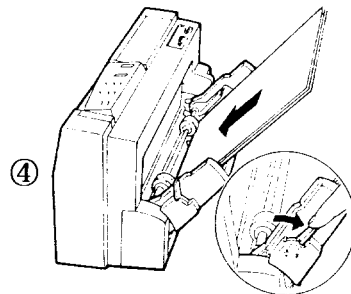
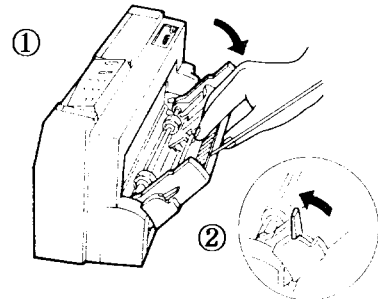

Loading paper from the rear path

The rear feed path is the best way to print those thicker sheets. Use this path for printing post cards, overhead projection (OHP) film and Iron-on Transfer Sheets. This feed path can handle widths of 100.0 to 242.0mm (3.94 - 9.53in.) and lengths of 100.0 to 355.6mm (3.94 - 14.0 in.). It can also handle paper thicknesses of 0.06 to 0.23mm (0.00236 - 0.00906 in.).

Steps:

Make certain that the power is ON.

1. Place the paper tray in its vertical position. The printer will automatically enter the Not Ready mode. The **Ready** lamp will not be lit. The **Paper** lamp will light.
2. Move the paper release lever, located on the front side of the printer, to the lower position.
3. Align the paper to the size of paper you will use with the page markers on the printer.
4. Paper will automatically feed to the top of form position.
5. When you have confirmed that the paper has been fed to the top of form correctly, press the **Ready** key to enter the Ready mode. The **Ready** lamp will illuminate.

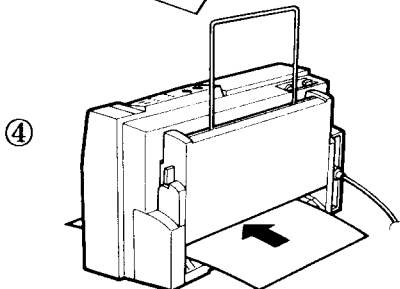
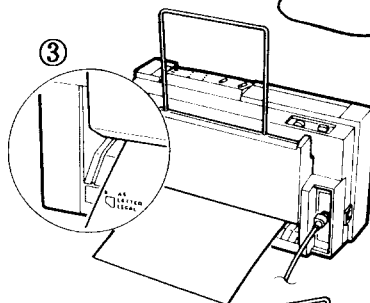
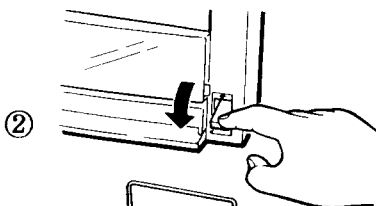
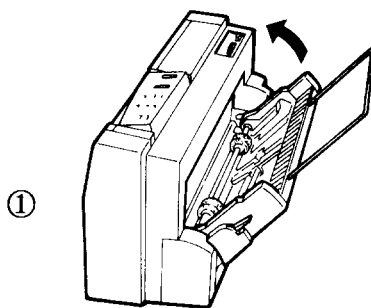

Note: When the best quality graphics output is desired, please use the rear feed path.

You can use paper thicknesses of 0.06mm to 0.23mm (0.00236 - 0.00906 in.) with the rear feed path. Allow a one second interval between paper feeds. Paper will be fed automatically to the top of form position when inserted. If paper is being fed incorrectly, clear the problem and start again. See Clearing paper jams on page 11.

Caution: Always use the rear path when using overhead projection (OHP) film.

Loading paper from the front path

The front feed path feeds paper one sheet at a time. When using this path, paper will exit the machine from just above where it was inserted. Use this paper path only for printing text or graphics on single sheets. This feed path can handle widths of 100.0 to 242.0mm (3.94 - 9.53in.) and lengths of 100.0 to 355.6mm (3.94 - 14.0 in.). It can also handle paper thickness of 0.06 to 0.10mm (0.00236 - 0.00394 in.).

Steps:

Make certain that the power is ON.

1. Place the paper tray in its vertical position. The printer automatically enters the Not Ready mode. The **Ready** lamp will not be lit.
2. Move the paper release lever, located on the front side of the printer, to the lower position.
3. Align the right edge of the paper with the proper page marker on the printer.
4. Paper will automatically feed to the top of form position. When printing, paper will return with the print face up.
5. When you have confirmed that the paper has been fed to the top of form properly, press the **Ready** key to enter the Ready mode. The **Ready** lamp will illuminate.

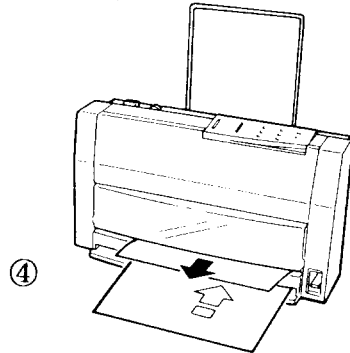
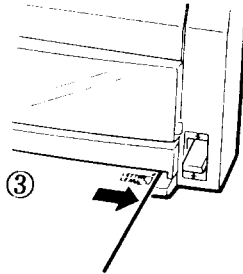
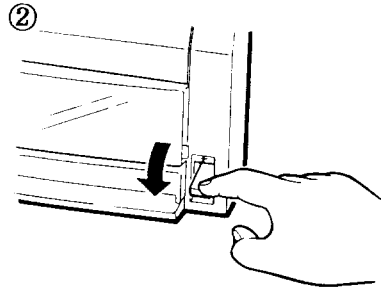

Caution: Always insert paper with the side on which you want to print facing downward when printing with the front path.

Note: Allow a one second interval between paper feeds. Paper will be fed automatically to the top of form position when inserted. If paper is being fed incorrectly, clear the problem and start again. See Clearing paper jams on page 11.

Clearing paper jams

If paper becomes jammed, the **Paper** lamp on the control panel will flash and the printer will enter the Not Ready mode. When this happens, remove the jammed paper according to the following steps.

Steps:

1. Lift up on the paper release lever, located on the front side of the printer.
2. Remove the jammed paper carefully by pulling on the end of the paper.
3. Open the front cover and confirm that there is no more paper jammed inside.
4. Pull down the release lever.
5. Confirm that there is no slack in the ribbon. If there is slack, see page 4, "Installing the ribbon cassette," for details.
6. Close the front cover.
7. Load a new sheet of paper and press the **Ready** key to enter the Ready mode. The **Ready** lamp will illuminate.

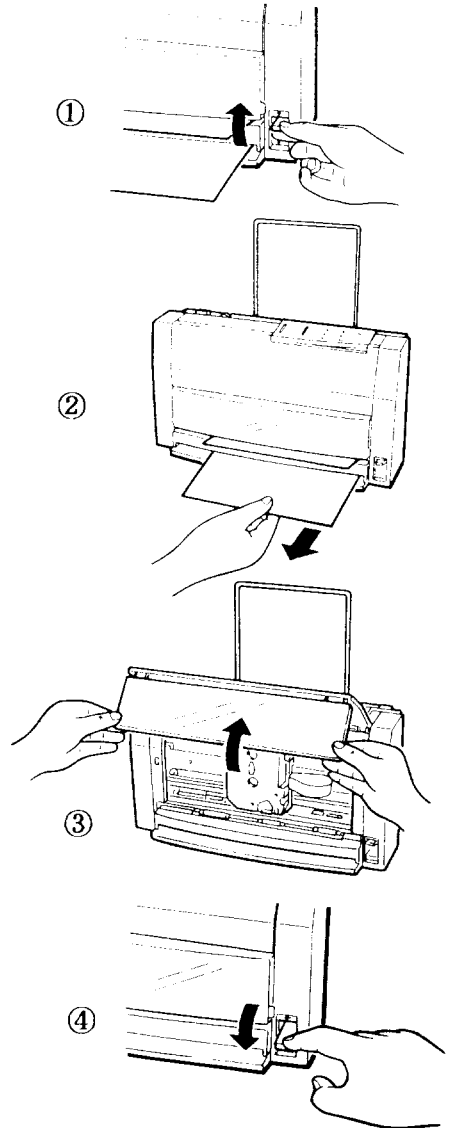



Chapter 3 Installing the printer driver and TrueType fonts

You must install the printer driver to your hard disk before you can print. The floppy disks which came with your printer include the printer driver and TrueType Fonts. In this chapter, we will explain the easy steps to installing both of these using System 7.X as an example. For details on installation to System 6.0, please see your Macintosh User's Guide.

Minimum system requirements

The minimum system requirements for the SJ-144MC are:
System 6.05 or later, Color QuickDraw and 2MB of RAM or System 7.X, Color QuickDraw and 4MB of RAM.

Checking the system software

Your printer is capable of printing virtually any off-the-shelf Macintosh software. However, we suggest that you take a moment to check which system software you are currently using.

Open the  menu in the upper left hand corner of your display and select **"About This Macintosh."** If your system is 7.0 or later, you can proceed to "Installing your printer driver and TrueType Fonts."

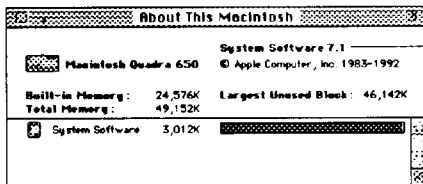
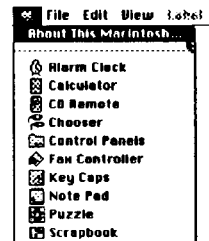

This is the System Software version number.

Note: If you have a system software version earlier than system 6.0, you will need to up-grade to either System 6.05 or 7.1.

If you are running System 6, you will need to start up MultiFinder. To start up MultiFinder, please follow these steps.

Steps:

1. Choose Special from the Finder window.
2. Select Set Startup.
3. Click on MultiFinder.
4. Restart your system.

MultiFinder will appropriately allocate your system memory so that you can print with the SJ-144MC.

Installing the printer driver

To install the printer driver in System 7.1, just follow the **Steps** below.

Steps:

1. Before you install the printer driver software and TrueType Fonts, take a few minutes to create back-ups of the floppy disks. Use them to install this software. Check your Macintosh User's Guide for more information concerning making copying disks.
2. Insert the copied floppy disk 1 into the floppy disk drive of your Macintosh and open it by double-clicking on it with your mouse.
3. Open up the finder by double-clicking the hard disk icon in the upper right hand corner of your display.
4. Click on the folder for the language you use and drag and drop the SJ-144MC icon into the system folder of your hard disk.
The system will automatically place this printer driver into your Extensions folder on your hard disk.
5. Restart your system.

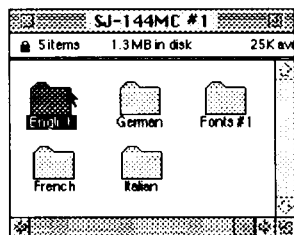
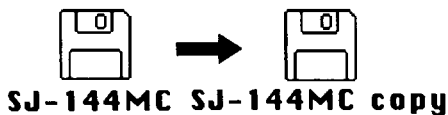

Note: You must place this printer driver into the **Extensions Folder** in System 7 in order to make it available to your Macintosh. Check your Macintosh User's Guide for more information. If a driver with the same name already exists in that folder, a dialog box prompting you to replace it will appear. This should not happen the first time you install the driver, but it will when you install a revised version. In that case, click **OK**.

Note: You should always make back-up copies of all of your original floppy disks before installing their contents.

Installing the TrueType fonts

The 35 TrueType fonts are located in the folders called **Fonts** in both of the floppy diskettes which came with this printer. To install the fonts in System 7.1, just follow the Steps explained below.

Note: TrueType fonts will not work on System 6.

Steps:

1. Double-click on the **Fonts** folder in floppy disk #1. You will see 9 font suitcases in this folder. To install them, all you need to do is to drag your mouse pointer over each of the ones you want to install and drag and drop them onto the system folder on your hard disk. Your system will automatically place the fonts you have selected into the "Fonts" folder on your hard disk drive.

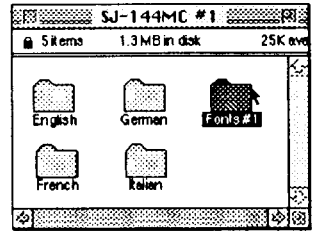

If the **Fonts** window on the floppy disk is active and you want to select all of the fonts on this disk, you can select them all using the "**Select All**" item in the **Edit** menu.

Then, as explained above, just drag and drop them onto the system folder on your hard disk.

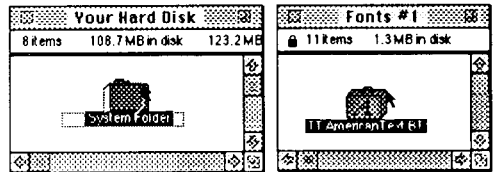

2. Remove floppy disk # 1 and insert floppy disk #2. This floppy holds the remaining 26 TrueType fonts. To install these, just repeat the process explained above.

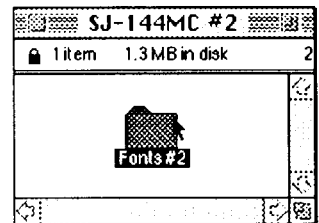

Note: Your TrueType fonts must be in the **Fonts** folder of the System folder in System 7.

Getting started

To use your new printer, you must inform the **Chooser** that a new or replacement driver has been added to its internal lists. Select **Chooser** from the  pull-down menu. Make sure your printer is ON and ready and that it is connected to a port on your Macintosh. Select the SJ-144MC icon and the port to which it is connected. AppleTalk should be set to **Inactive** in the **Chooser**.

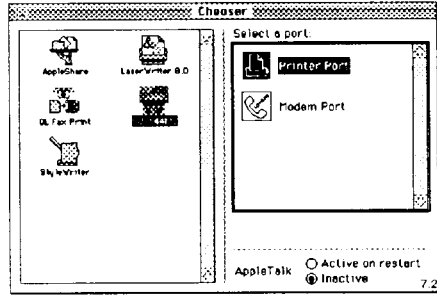

After making the necessary selections and closing the **Chooser** dialog box, a message like the one at right will prompt you to make any page setup changes in all of open applications. Click **OK**. Now you can print with your new printer and use the 35 scalable TrueType Fonts.

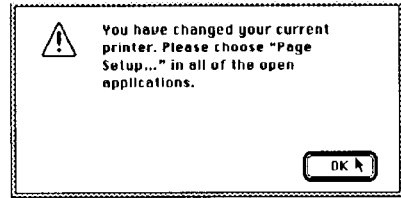

Scalable TrueType Font Samples

American Text

Broadway

Brush 445

Caslon Openface

Cloister Black

Commercial Script

Cooper Black

DAVIDA

Dom Casual

ENGRAVER'S ROMAN

EXOTIC 350 DEMI BOLD

Freeform 721

Freehand 521

Handel Gothic

Hobo

Humanist 521 Extra Bold

Impress

Kaufmann

OCR

Old Dreadful No. 7

Onyx

Orbit-B

Parisian

Park Avenue

Playbill

P.T. Barnum

Raleigh Demi Bold

Shadow Black Condensed

Seagull Heavy

SHOTGUN

Tango

University Roman

VAG Rounded

Vineta

Windsor

Chapter 4 Printing

When using your printer with a Macintosh, you will probably be using either System 6.0 or 7.0. Your new printer will operate under either system and it can print documents from virtually any Macintosh application software. In this chapter, we will explain the meanings of the various dialog boxes which will appear on your display when you print.

Key and lamp explanation

The two keys on the front control panel are **PAPER** and **READY**.

The following is a brief explanation of the general use of these keys and the corresponding lamps.

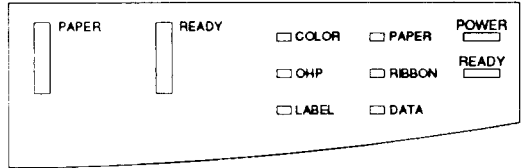

PAPER

This key performs the following functions. For details see the next pages.

- Top of form
- Line feed
- Paper eject

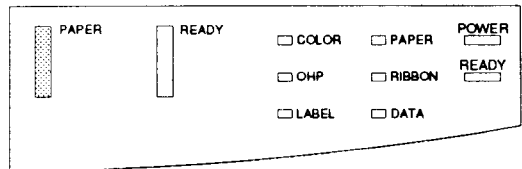

READY

- **READY** sets the printer to the Ready or Not Ready mode with each press. This allows the printer to be ready to receive and print data. The printer is in the Ready mode when the **READY** lamp is lit.
- The printer will power-up in the Ready mode if paper is loaded.

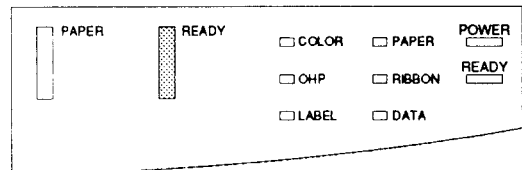

Conditions indicated by the lamps

This table explains the meanings of the lamps on the control panel.

Lamp	Meaning
POWER	Illuminates whenever the printer is turned ON.
READY	Illuminates when the printer is ready to receive data.
DATA	Flashes when there is data in the printer buffer. Extinguished when there is no data in the printer buffer.
PAPER	Illuminates when there is no paper in the manual feeding position, when there is an error with the Sheet feeder or when paper is jammed during paper eject. Extinguished when paper is feeding normally.
RIBBON	Illuminates when the printer detects the end of a ribbon.
COLOR	Illuminates when a color ribbon is installed.
OHP	Illuminates when a ribbon for overhead projection (OHP) film is installed.
LABEL	Illuminates when a label ribbon is installed. Flashes when the label ribbon and sheet are installed.
All lamps flashing	An error has occurred.

Caution: If all lamps are flashing, turn OFF the power to the printer, check Chapter 5 "Maintenance and troubleshooting" or contact your nearest service representative.

Key operations

Normally, the printer will load paper automatically from the paper tray when print data is received from the computer. However, you can load paper manually using the control panel.

Paper feed

There are three types of paper feed functions that you can easily master using the control panel keys. Each of these functions allows you to directly control the way paper is handled by the printer.

Top of form

If there is paper in the paper tray, top of form will send paper to the printing position.

Steps:

1. Press the **PAPER** key. Paper will automatically feed to the top of form position.
2. Press the **READY** key to enter the Ready Mode.

Line feed

Using the following operation will feed paper one line at a time if paper is at the top of form position.

Steps:

1. Press the **READY** key to enter the Not Ready mode. The **READY** lamp will extinguish.
2. Press and release the **PAPER** key and paper will automatically feed forward one line.
3. Holding the **READY** key down will feed paper in consecutive lines.
4. Press the **READY** key to enter the Ready mode.

Paper eject

This function will eject your paper from the printer when paper is at the top of form position.

Steps:

In the Ready mode:

Press the **Paper** key.

In the Not Ready mode:

1. Press the **READY** key to enter the Not Ready mode. The **READY** lamp will extinguish.
2. Press and hold the **PAPER** key. After 6 consecutive line feeds, the printer will enter the paper eject mode and will automatically eject paper from the printer.
3. Press the **READY** key to enter the Ready Mode.

Test mode

The test mode is performed by pressing the following key combinations. This mode is used to test the printing quality of your printer. When performed a document like the one below will be output.

Steps:

1. Press and hold the **READY** key while turning on the power to the printer. A print sample like the one below will be output.



Page Setup

After you have made the necessary selections in the **Chooser**, you can run your favorite application software to create documents for the printer. You do not have to use the **Chooser** each time you use this printer. You select a new printer, however, in the **Chooser** whenever you want to print using a different printer. Before you actually send the print job to the printer, you should take a few moments to confirm the printer driver's page settings. Use your mouse to select **Page Setup** in the applications **File** menu.

Note: Changing any settings regarding paper will cause the application software to automatically reformat your document.

Page Setup

Selecting **Page Setup** in the **File** menu will display this dialog box. Here you can make fundamental changes to your document. Below we will explain the meaning and usage of each of the elements of the Page Setup dialog.

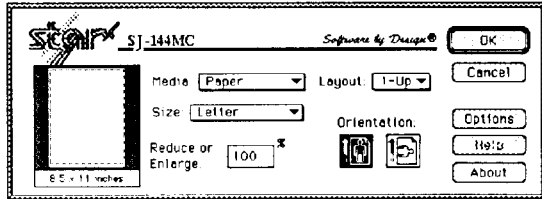

Media

This tells the printer to what type of print media you will be printing. The selections available are Paper and OHP Film.

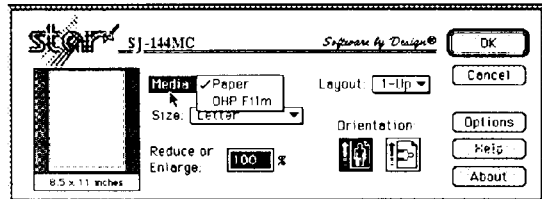

Size

This tells the printer the size of the media to which you will be printing. Sizes include: **Letter**, **DIN A4**, **DIN B5**, **Legal**, **Executive**, **Strip Labels...** and **Custom...** **Letter** is the default setting. Selections you make will be graphically represented in the window on the left side of the dialog box.

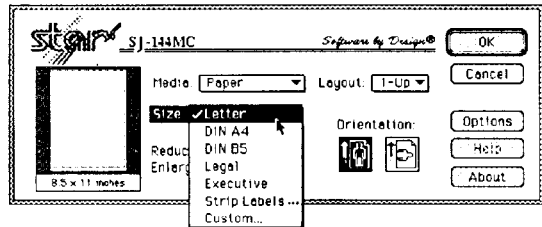

Custom...

Clicking on **Custom...** will allow you to freely set the size of the media you want to print, within the page size restrictions described in Chapter 2. After inputting the Width and Height sizes of your paper, you can easily change those values to millimeters or back to inches simply by clicking the appropriate checkbox.

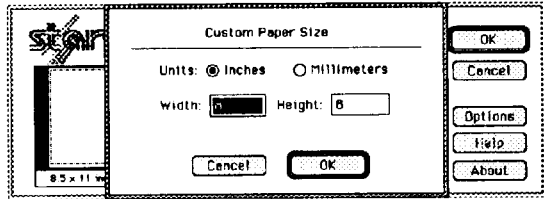

When you have finished making your changes, click **OK**. Your changes will take effect and will be represented in the window on the main screen. Clicking **Cancel** will close this dialog and ignore your selections. The default setting is 8 inches by 8 inches.

Strip Labels

This printer has a unique and handy Strip Label printing function with which you can create your own personalized labels for your books, tapes or files. Simply select **Strip Labels** from the **Page Setup** dialog box and input the Width in the user box. Again, when you have finished, click **OK**. Your changes will take effect and will be represented in the window on the main dialog box. Clicking **Cancel** will close this dialog and ignore your selections.

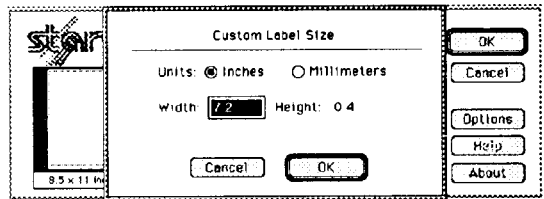

Note: Always make sure you have mounted a strip label cassette before printing with the **Strip Label** setting.

Reduce or Enlarge

With this setting, you can change the original size of the printed image on your paper from 20% to 400%. Any setting over 100% will result in tiled documents with your image spread across several pages. The values are input via your numerical key pad.

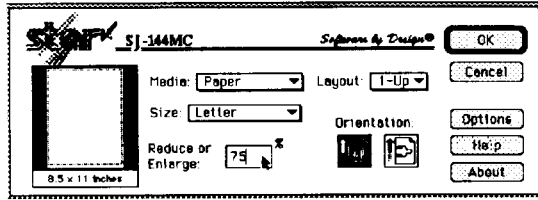

Orientation

This setting allows you to change the direction in which your image will be printed. You have the choices of Portrait or Landscape orientation. Portrait is the default setting.

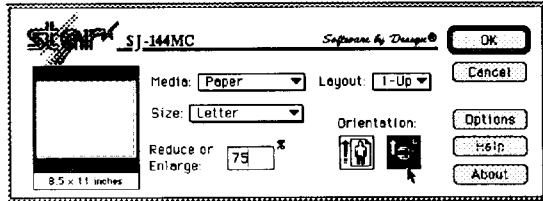

Layout

Layout includes two features. One is the 1-Up setting for printing each page of your documents on one piece of paper. The other setting is 2-Up which is a great cost saving device. It lets you print two pages of output onto one piece of paper. 1-Up is the default setting.

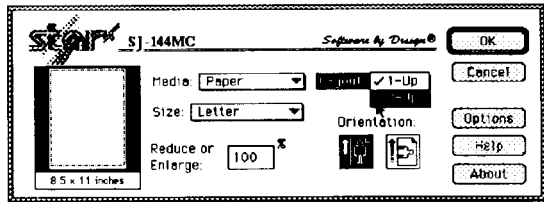

Options

Clicking **Options** will call up a dialog box like the one at the right where you can make further adjustments to printing your document.

The following briefly explains the meanings of each selection in the **Options** dialog box.

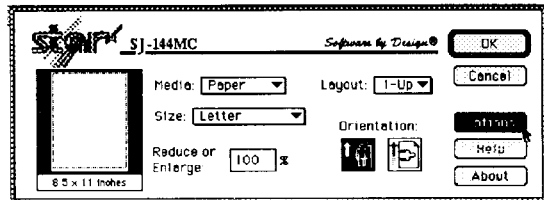

Flip Horizontal

If you want the image that you created to be reversed horizontally on the printed page, click on the **Flip Horizontal** checkbox. Your selection will be graphically represented in the illustration on the left side of the dialog box. You should use this option when you make iron-on transfer sheets.

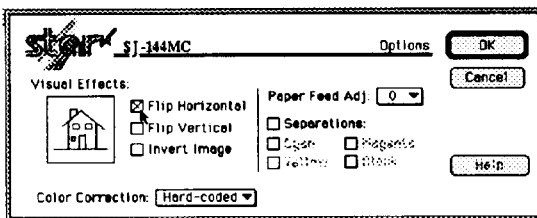

Flip Vertical

To print your created image vertically reverse of the image on your computer monitor, click the **Flip Vertical** checkbox before you print. Your selection will be graphically represented in the illustration on the left side of the dialog box.

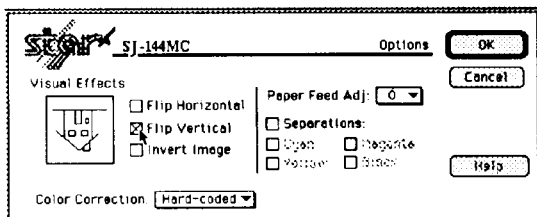

Invert Image

Clicking on this checkbox will invert the image of your printed page by changing all of the black dots to white dots and all of the white dots to black dots.

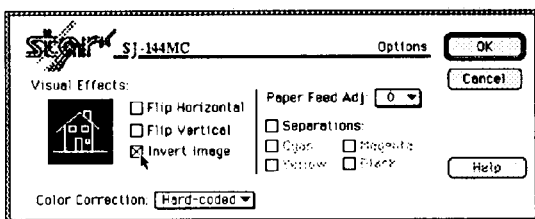

Color Correction

This option will allow you to apply color correction to your color documents from the available ColorSync profiles. Macs running System 7 may provide other options.

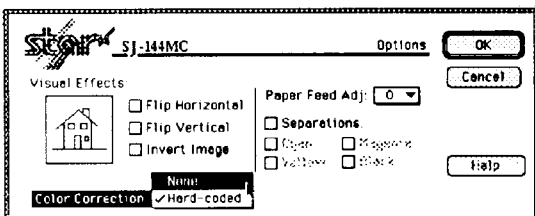

Paper Feed Adjustment

This will allow you to precisely adjust the printer's paper feed mechanism to optimize graphic and text print quality. It compensates for an effect known as *banding*, shown at the right, which results from using different paper types or feeding characteristics over a long period. Settings are from -3 to 3. Each value sets the feed pitch in increments of 1/720 of an inch. The higher numbers will increase the amount of line feed to eliminate Dark Line Banding, and the lower numbers will decrease the amount of line feed to eliminate White Line Banding. 0 is the default setting.

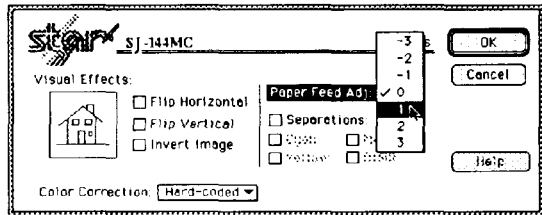

MW

Optimized Print Quality

MW

White Line Banding

MW

Dark Line Banding

Note: Always use a monochrome ribbon for this adjustment. When the best quality graphics output is desired, please use the rear feed path.

Separations

Clicking **Separations** will cause your printer to print out a single monochrome page of your graphic image for each color you have selected.

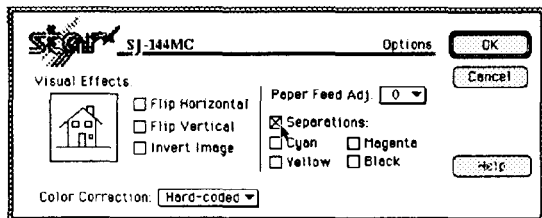

Note: Always use a monochrome ribbon when printing color separations.

OK/Cancel

Clicking **OK** will accept the selections you have made, close the **Options** dialog box and return to the previous dialog box. Clicking **Cancel** will ignore your settings and will close the dialog box.

Printing documents

When you have completed your document and you are ready to print, select **Print** from the **File** Menu. When you do this, a printer dialog box similar to this will appear on your monitor. This dialog box may differ somewhat according to the application software you are using, but the basic functions offered here do not change. We'll explain the meaning and usage of each of the elements of this printer driver.

Copies

The default is 1, but you can set the number of copies you want by selecting this box with your mouse. You can also select the number of copies by moving the cursor to this box using the tab key on your keyboard and typing the number of copies.

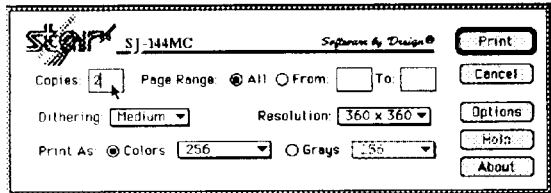
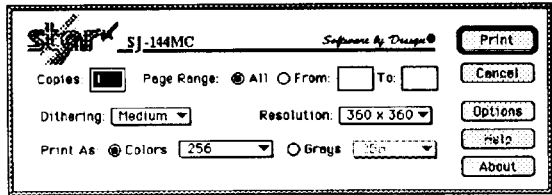

Caution: Remember that the printer's Paper tray holds a maximum of 30 cut sheets. Using more than 30 sheets will cause paper jams.

Page Range

This setting allows you to set the beginning and ending pages of a print job. This feature is useful when you want to print a limited number of pages in a multi-page document. The default setting is **All**. To change this setting, click on the circle next to **From** or press tab on your keyboard and enter the number from where you wish to begin printing. Move the cursor to the **To** box by clicking on it with your mouse or by pressing the tab key on your keyboard. Enter the value and press Print if your settings are correct.

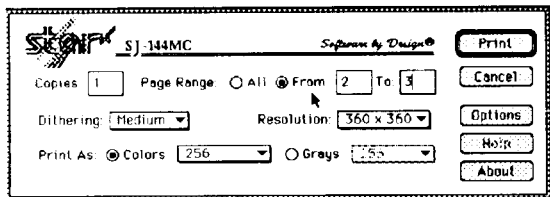

Resolution

Resolution allows you to set the number of dots per inch when printing. You can select between 360 × 360, 180 × 180 and 72 × 72 dpi. A lower dpi decreases output quality, but increases printer speed. This is especially helpful for quick memos that don't require fine quality output.

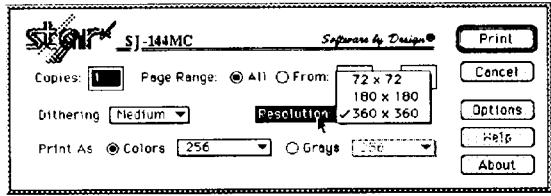

Dithering

This software includes 6 dither patterns for your use. They are **Line Art**, **Finest**, **Finer**, **Fine**, **Medium** and **Coarse**. These pattern selections range in print quality from less detailed printing of your images, with the **Coarse** setting, to very fine and high quality, with the **Line Art** setting. Finer settings, such as **Finest** and **Line Art**, will give your graphic images more half-tones which results in a more realistic appearance.

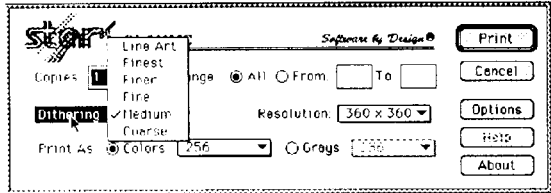

Note: No single dither pattern is best for all images. We have provided you with six choices to allow you to use the best pattern for any given image.

Print As: Colors

This setting allows you to tell the printer the number of colors were used to make your document. This helps make the printer's output as close to your original as possible. Settings include 16, 256, Thousands and Millions. The default setting is 256.

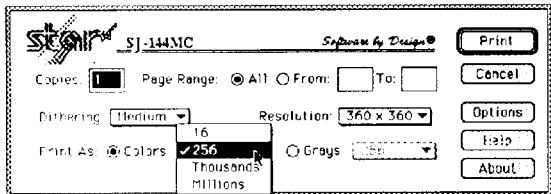

Print As: Grays

This will tell the printer the number in the gray scale used to make your document. This also helps make the final print as close to your original as possible. Settings include **Black & White, 16** and **256**.

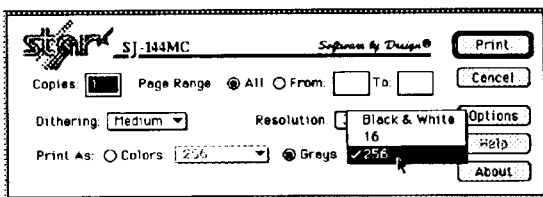

Print

Clicking on **Print** will start the print job on your printer with the selected changes. **Cancel** will ignore all of your changes and will close this dialog box.

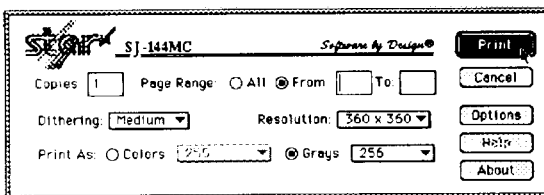

Help

If you need help concerning any of the printer's other functions, simply click on **Help** in any of this driver's dialog boxes for clear, succinct and helpful explanations. When you have finished reading your selection, click **Done** or press the **Return** key to return to the previous dialog box.

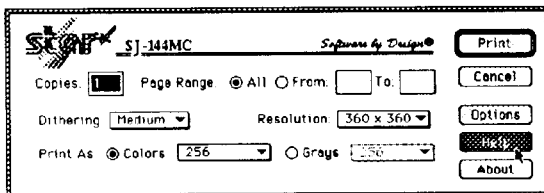

About

The **About** button will call up the name and version number of this printer driver.

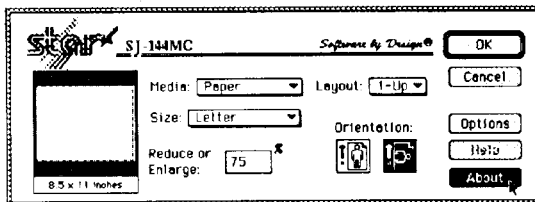

Using the other printing functions

This section explains the other printing capabilities. The operating procedures are basically the same as normal printing, although you should observe the following points for optimum printing quality.

Printing with color ribbons

When printing with color ribbons, you can print just as you would with the monochrome ribbon. Just remember the following points.

- When you insert a color ribbon, the **Color** lamp will light.
- You may insert paper from any of the three feed paths.
- Be aware that if you use large amounts of one particular color at one time, the ribbon life will be shortened. Always try to create color documents which use a relatively even spread of color choices in order to use the full capacity of the color ribbon.

Printing with overhead projection (OHP) film

When printing on overhead projection (OHP) film you should remember the following points.

- Always use the ribbon especially made for overhead projection (OHP) film. When you insert this ribbon, the **OHP** lamp will light.
- Always feed overhead projection (OHP) film from the rear feed path.
- Always select **OHP Film** in the **Media** setting of the printer driver's **Page Setup** dialog box.

Printing with strip labels

The maximum printing length, when using strip labels, is 7.2 inches. The following explains the steps when using strip labels. Always select **Strip Labels** in the **Size** setting of the printer driver's **Page Setup** dialog box.

Steps:

1. Turn the printer OFF.
2. Remove all paper from the printer including the paper tray and front and rear feed paths. Open the front cover and remove the ribbon cassette. See Chapter 1 "Installing the ribbon cassette" for details. Place the paper tray in the vertical position.
3. Confirm that the tip of the strip label is sticking out from the slit in the cassette. If the tip is not sticking out from the cassette, gently pull it out from the bottom of the cassette with your fingers. Make certain that the label strip fits through the cassette slit.

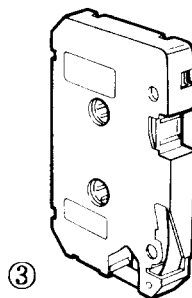

4. While gently lifting up on the protruding portion of the strip label, mount the Label cassette onto the carriage. Make sure that the ribbon and the label are between the print head and the platen.

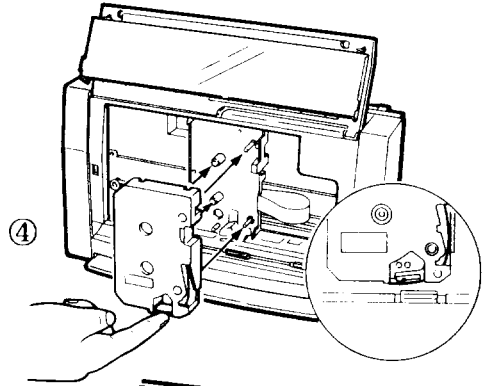

5. Close the front cover.
6. Turn ON the power to the printer. The Label lamp will light.

7. When label printing is complete, open the front cover and cut the end of the label using a scissors, as shown in the illustration at right. Be careful not to touch the ribbon.

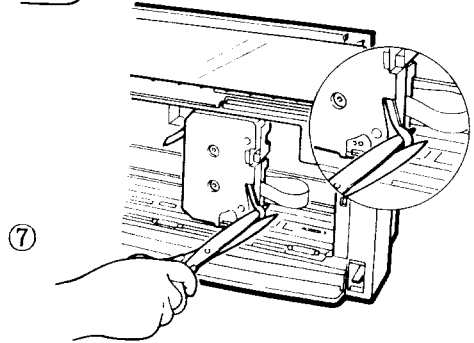

8. Grasp the other end of the cut strip label with your fingers and pull the label through the cassette as shown in the illustration at right. If the printed label is not long enough to go to exit side of the cassette, you can pull the label back through the opening where it was cut.

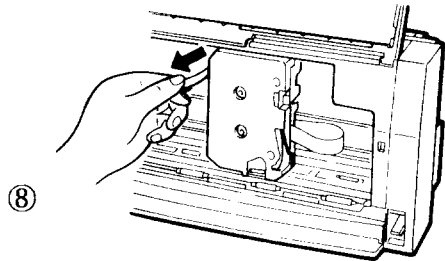

9. Peel off the backing of the cut strip label before attaching it.

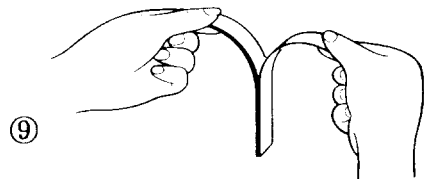

Caution: Always use genuine Star supplies to ensure optimum print quality. We do not guarantee printing quality when using ribbons by other manufacturers.

Note: In the Page Setup dialog box under **Size**, you must click on strip label in order to use this function.

Printing with iron-on transfer sheets

The iron-on transfer is a great way to create original designs for T-shirts or other clothing. When you are printing iron on transfer sheets, always select **Paper** in the **Media** setting of the printer driver's **Page Setup** dialog box.

Steps for printing on the transfer sheet

1. Create an image with your software program. Use the software's reverse image (mirror) function. See "Flip Horizontal" on page 21 for details.
2. Install the special transfer ribbon in the printer following the instructions in Chapter 2.
3. Insert the transfer sheet from the rear feed path, as shown in the illustration at right.
4. Print your image on the transfer sheet.

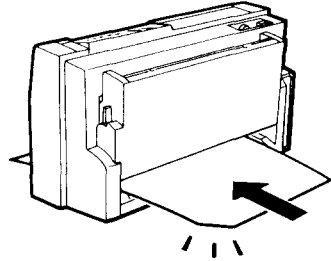

Steps for transferring the image on the cloth

1. Cut out the image on the transfer sheet leaving approximately 1/2" margin around the image. Round off the corners because this will reduce the chance of the image peeling off.
2. Carefully position the transfer sheet on the cloth with the image side down.
3. Uniformly iron the transfer sheet with the iron set to 320°F (160°C). Do not remove the transfer sheet until it has cooled to room temperature.
4. Slowly remove the transfer sheet from the cloth starting from a corner.



Steps for the finishing process

1. Place the finishing sheet over the image on the cloth, with the cut out corner in the top left. Make sure that the silicon side is down. The finishing sheet should completely cover the image.
2. Iron the finishing sheet at the same setting used to iron the transfer sheet.
3. Do not remove the finishing sheet until it has cooled to room temperature.
4. Slowly remove the transfer sheet from the cloth starting from a corner.
5. If the image seems like it will peel off of the cloth, repeat the finishing process.



Note: Always use the rear feed path when using the iron-on transfer sheets.

Chapter 5 Maintenance and troubleshooting–

Your printer is a solid state instrument, but it should, nonetheless, be treated with care to maintain its high performance. If you abide by these few rules you can expect your printer to perform well for a long time.

Requirements

- Always keep your printer in a comfortable environment. (See Chapter 1 for details.)
- Do not subject your printer to jarring or vibration.
- Avoid setting your printer in a dusty environment.
- Clean your printer periodically. (See the following page.)
- Never allow liquid to get inside of the printer.
- The interior of the printer may be cleaned with a small vacuum cleaner or compressed air-aerosol which is sold for this purpose. Take special care not to bend or damage any of the cable connections or electronic components when cleaning.
- Always use the AC adapter provided with this printer. Using an AC adapter from another source may cause electrical malfunction.

Cleaning the printer

You can keep your printer in fine working condition if you periodically clean your printer using these procedures.

Warning: Always turn OFF the power to the printer when cleaning. Always remove the AC adapter from the wall outlet. Always read the directions of all cleaners before use. Be especially careful of fires when using alcohol to clean your printer. Never touch the print head with your hands as this may degrade the printing quality.

Cleaning dirt from the printer

- Wipe off all dirt and dust from the printer case and cover with soft cloth. If some dirt is particularly difficult to wipe away, apply a small amount of isopropyl alcohol to the cloth. Be especially careful not to allow any liquid to get inside of the printer.
- Use a soft brush to sweep any dust and dirt away from the inside of the printer. Be careful not to damage any of the electronic circuits or wiring.

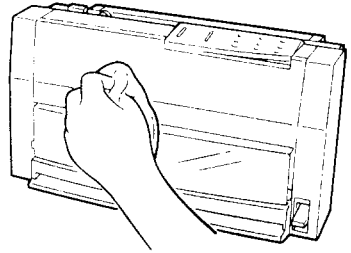

Cleaning the print head

When the print head becomes dirty, printing quality will not be stable even if printing intensity is adjusted. Follow the directions below to clean the print head.

- Prepare cotton swabs and isopropyl alcohol.
- Turn OFF the power to the printer.
- Open the front cover and remove the ribbon cassette.
- Insert an overhead projection sheet between the print head and the platen to prevent the platen from coming into contact with the isopropyl alcohol.
- Apply the isopropyl alcohol to the cotton swab and lightly wipe the head.
- Perform a test (described in Chapter 4) to confirm the printing quality.

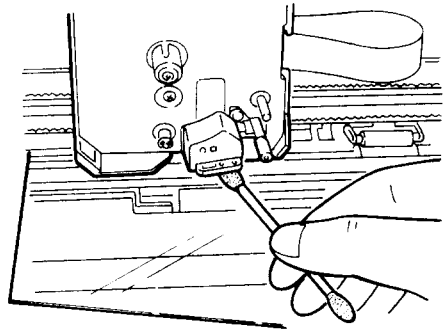

Warning: Paper feeding defects may occur if the platen comes into contact with the isopropyl alcohol. Be careful not to let any alcohol to come into contact with the platen.

Cleaning the platen

If the platen becomes dirty from having been directly printed on, etc. paper will not feed correctly and there will be deletions from your documents.

- Prepare cellophane tape.
- Turn OFF the power to the printer and open the front cover.
- Remove the ribbon cassette.
- Place a piece of cellophane tape over the area on the platen that needs to be cleaned.
- Firmly rub your finger along the length of the tape.
- Slowly peel the tape off the platen.
- Repeat the process until the platen is clean.
- Replace the ribbon cassette.
- Load paper and confirm that it feeds correctly.

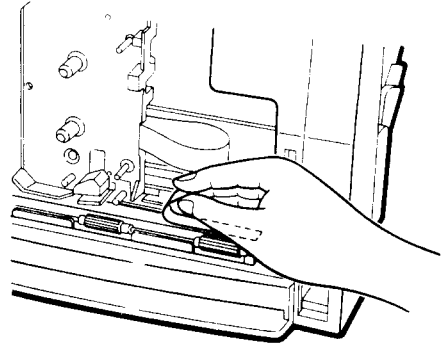

Cleaning friction rollers

Clean the rollers when paper does not feed correctly.

- Prepare isopropyl alcohol and cotton swabs.
- Turn OFF the power to the printer.
- Open the front cover.
- Apply the isopropyl alcohol to the cotton swabs and wipe the rollers.
- Load paper and confirm that it feeds correctly.

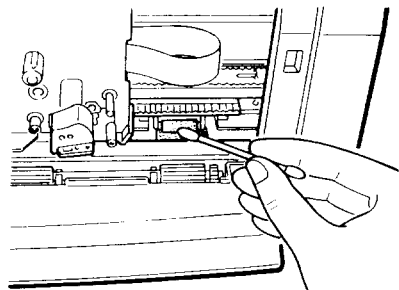

Warning: Paper feeding defects may occur if the platen comes into contact with the isopropyl alcohol. Be careful not to let any alcohol to come into contact with the platen.

Troubleshooting

Your printer is a reliable, precision instrument and should not cause you any trouble if it is used and treated sensibly. However, we are providing you with this section devoted to troubleshooting should you encounter any problems with your printer. Remember that your printer is a highly sophisticated device and that this section is intended to be only a brief guide. As with many other precision instruments, this printer contains high voltage. We request that you perform only the operations which are explained here.

Warning: Any attempt to perform troubleshooting operations other than those described here may result in electric shock or damage to the printer.

The following table is provided to give you an idea of where to find a solution to the type of problem you have encountered.

Region of fault	Description
Power supply	Power is not being supplied to the printer (See page: 37)
Printing	The printer does not print, or it stops printing. (See page: 37) The print is faint or uneven. (See page: 38) While using application software, fonts or characters cannot be printed. (See page: 38) The print-out is not what you expected. (See page: 38) The print shows evenly spaced rows of dark or white lines. (See page: 39)
Paper feeding	The paper tray is not operating or is not feeding paper properly. (See page: 39) Paper does not feed properly with the front and rear feed paths. (See page: 40)

Power Supply

If the **Power** lamp does not illuminate or flash, check the following.

Check	Possible Remedy
Is the AC adapter cable properly plugged into the electrical outlet?	Turn the printer OFF. Ensure that the AC adapter cable is securely connected and turn the printer back ON.
Is power being supplied to the outlet?	Turn the printer OFF. Unplug the AC adapter and try another electrical appliance to determine if electricity is being supplied to the same outlet.
Is the printer voltage correct?	Always use the AC adapter which came with this printer.

Printing

If your printer does not print, or it suddenly stops printing, check the following.

Check	Possible Remedy
Is the interface cable connected securely?	Check both ends of the cable - printer and computer to make sure that the connector is firmly in position.
Have you selected the proper port	The port selected in the Chooser must be the same as the port to which the interface cable is connected.
Is the Ready lamp illuminated?	If it is not illuminated, press the Ready key to set the printer to the Ready mode.
Is paper jammed?	If it is, remove it and replace the paper to continue printing. Make sure that the loading edge of the paper is smooth and is not creased.
Is the software you are using properly installed for your printer?	Check the installation settings in your software and re-install it if necessary.
Can the printer perform self tests?	Turn the printer OFF and turn it back ON while holding down the Ready key to perform the self test. The printer will print one test page. If you turn on the printer while holding the Paper key it will print continuous test pages. If the printer is set to the strip label mode the self test will not work. If this does not work, contact your dealer.
Is the ribbon depleted or broken?	If the ribbon is depleted or broken, replace it with a new one.

If the print is faint, or uneven, check the following.

Check	Possible Remedy
Is the print density knob turned down?	If it is, turn it back to your desired darkness. The factory setting is maximum.
Is the ribbon cassette installed properly?	Turn OFF the power. Check to make sure that the ribbon is sitting properly on the cassette carriage.
Is the ribbon worn out?	Replace the ribbon.
Are you using a Star Micronics ribbon?	Always use genuine Star Micronics supplies.

If your application software cannot print the fonts or characters selected, check the following.

Check	Possible Remedy
Is your application software properly installed?	Check the software installation, and re-install the software, if necessary.
Are fonts not being selected properly?	Check the software installation, and insert the commands necessary for font changes into the software.

If the print-out is not what you expected.

Check	Possible Remedy
Is the printer driver set correctly?	You may have accidentally set one of the page setup settings incorrectly. Recheck your page setup settings.
Is the print driver installed correctly?	Your printer driver may not have been installed properly. Try re-installing the printer driver.

If the print shows evenly spaced rows of dark or white lines, check the following.

Check	Possible Remedy
Is the paper feed adjustment in the printing options dialog box set too low?	If it is, try returning to the default setting. Please refer to Chapter 4.
Are you using genuine Star products?	We recommend that you use only genuine Star products to maintain high printing quality.

Paper feeding

If the paper tray is not operating or is not feeding paper correctly, check the following.

Check	Possible Remedy
Are the levers set properly?	Set the paper tray lever to the rear position, and the paper release lever to the lower position.
Is paper jammed near the print head?	Stop printing, remove the jammed sheet and continue printing.
Are the left and right paper guides too close together?	If the guides are too close together, the paper will not feed smoothly. Move them a little further apart to allow the paper to feed freely.
Is there too much paper in the paper tray?	The paper tray holds up to 30 sheets of paper at a time. Make sure that there is no more than that in the tray.
Was the paper fanned before being fed by the paper tray?	If this is not done, paper jams may occur. Remove the stack of paper from the paper tray and fan it before re-inserting.
Has the paper been used before or is it creased?	Only new, uncreased paper should be used with the paper tray.
Are you trying to feed one line using the front panel key while the Ready lamp is ON?	You can only feed one line at a time when the printer is in the Not Ready mode.
Is the paper too thick or too thin?	There are limits to the thickness of the paper. Try different paper.

If paper isn't feeding smoothly with the front and rear feed paths, check the following.

Check	Possible Remedy
Is the paper release lever pushed down?	Set the release lever to the downward position.
Are you trying to feed paper through the rear while the paper tray is still engaged?	Remove paper from the paper tray and place it in the vertical position.
Is the paper too thick?	There are limits to the paper thickness. Try feeding different paper.

Chapter 6 Reference information

Specifications

Printing system	Plain paper, Heat fusion process	
Resolution	360 × 360 dots per inch	
Print speed	At 7.5 lines per inch	At 6 lines per inch
Pica (10 CPI)	306 cps	255 cps
Elite (12 CPI)	367 cps	306 cps
Semi-condensed (15 CPI)	459 cps	382 cps
Condensed pica (17 CPI)	520 cps	433 cps
Condensed elite (20 CPI)	612 cps	510 cps
	Note: 50% speed reduction in Color, OHP, and Label modes. Print speeds have been estimated for each font because the SJ-144MC printer does not have bitmapped fonts.	
Printing direction	Uni-directional logic seeking	
Printing head	144 elements Distance between elements: 1/360 inch	
Font styles	American Text, Broadway, Brush 445, Caslon Openface, Cloister Black, Commercial Script, Cooper Black, DAVIDA, Dom Casual, Engravers' Roman, Exotic 350 Demi Bold, Freeform 721, Freehand 521, Handel Gothic, Hobo, Humanist 521 Extra Bold, Impress, Kaufmann, OCR, Old Dreadful No. 7, Onyx, Orbit-B, Parisian, Park Avenue, Playbill, P.T. Barnum, Raleigh Demi Bold, Schadow Black Condensed, Seagull Heavy, Shotgun, Tango, University Roman, VAG Rounded, Vineta, Windsor Note: TrueType fonts are supplied on diskette for use with Macintosh applications running System 7 or later.	
Raster graphics	360 dots per inch	
Number of columns		
Pica (10 CPI)	80	
Elite (12 CPI)	96	
Semi-condensed (15 CPI)	120	
Condensed pica (17 CPI)	137	
Condensed elite (20 CPI)	160	
Proportional	Variable	

Paper feed	Single bin paper tray with 30 sheet capacity Friction roller feed from the front of the printer Friction roller feed from the rear of the printer
Paper feed speed	380 ms (line feed at 144/360 inch)
Paper specifications	
Width	3.94" - 9.53" (100.0 - 242.0mm)
Length	3.94" - 14.0" (100.0 - 355.6mm)
Thickness	Paper tray: 0.00236" - 0.00394" (0.06 - 0.10mm) Rear path: 0.00236" - 0.00906" (0.06 - 0.23mm)
Surface	Xerography-quality or smoother (Such as Xerox #4024 or Hammermill's LaserPrint paper #10460-4) Laser-quality overhead projection (OHP) film, and label sheets can also be used.
Maximum buffer size	35KB + 2 line buffer (102KB)
Acoustic noise	45.5dBA
Emulation	CDM corresponds to Apple QuickDraw
Interface	RS-422A Serial 8 Pin 57.6 KBps
Environment	
Temperature	Stand-by: +5 to +35° C (41 to 95° F) Operating: +5 to +35° C (41 to 95° F) +10 to +30° C (50 to 86° F) for Color, OHP, Label
Humidity:	Storage: -25 to +60° C (-13 to +140° F) Stand-by: 30 to 90 % RH (No condensation) Operating: 30 to 70 % RH (No condensation) Storage: 30 to 90 % RH (No condensation)
Reliability	
Mean-time between failure (MTBF)	10,000 hours
Maximum recommended duty cycle	2,000 power-on hours per year
Print head life	50 million pulses per element
Dimensions and Weight	
Width	325mm (12.8")
Depth	140mm (5.5")
Height	175mm (6.9")
Weight	2.5 Kg (5.5 lbs)

AC adapter power supply	120VAC, 220VAC, 230VAC, 240VAC, 50/60Hz (varies according to the country of purchase)
Features	<p>Full color and monochrome laser quality printer</p> <p>Speed: up to 382 CPS (15 CPI) in laser quality mode</p> <p>3 paper feed paths with 30 sheet paper tray</p> <p>Ability to print on a wide variety of print media including: Laser-quality plain paper, recycled paper, OHP film, etc.</p> <p>35 scalable TrueType fonts for Macintosh application running System 7 or later.</p>

Printer supply options

Ink ribbon cassette for plain paper

T144BK	<p>Type: Monochrome ribbon (one time use)</p> <p>Life: 345,000 characters (12CPI, 6 LPI) 180 pages/cassette (1500 characters per page)</p> <p>Length: 340 m (371.82 yards)</p> <p>Width: 12.7mm (0.5")</p>
T144CL	<p>Type: Color ribbon (one time use)</p> <p>Life: 8.0 pages per cassette (8.0" × 9.6" Full graphics per page.)</p> <p>Length: 193 cycles, 210 m (229.66 yards)</p> <p>Width: 12.7mm (0.5")</p>

Ink ribbon cassette for overhead projection (OHP) film

T144BKO	<p>Type: Monochrome ribbon (one time use)</p> <p>Life: 200,000 characters (10CPI, 6LPI) 100 pages/cassette (1500 characters per page)</p> <p>Length: 200 m (218.72 yards)</p> <p>Width: 12.7mm (0.5")</p>
T144CLO	<p>Type: Color ribbon (one time use)</p> <p>Life: 10.5 pages per cassette (8.0" × 9.6" Full graphics per page.)</p> <p>Length: 257 cycles, 270 m (295.28 yards)</p> <p>Width: 12.7mm (0.5")</p>

Overhead projection (OHP) film

T90OF-LTR Type: Overhead projection (OHP) film
Size: Letter
Packaging: 20 films

T90OF-A4 Type: Overhead projection (OHP) film
Size: A4
Packaging: 20 films

Iron-on Transfer Sheets

T90IO-LTR Type: Iron-on transfer sheets
Size: Letter
Packaging: 10 Transfer Sheets

T90IO-A4 Type: Iron-on transfer sheets
Size: A4
Packaging: 10 Transfer Sheets

Ink ribbon cassette for iron-on transfer sheets and glossy paper

T144IO Type: Color Ribbon (one time use)
Life: 7.5 pages per cassette
 (8.0" ×9.6" Full graphics per page)
Length: 180 cycles, 185m (202.32 yards)
Width: 12.7mm (0.5")

Ink ribbon cassette for strip labels

Strip Label Cassette Type: Single color printing on single color background
160 labels per cassette (1.8 inches per label)
Maximum label length: 7.2" (printable)
Strip label height: 0.5"

<u>Model #</u>	<u>Background Color</u>	<u>Printing Color</u>
T01SL	Transparent	Black
T02SL	White	Black
T03SL	Red	Black
T04SL	Blue	Black
T05SL	Green	Black
T06SL	Yellow	Black
T07SL	Gold	Black
T08SL	Silver	Black
T31SL	Transparent	Red
T32SL	White	Red
T41SL	Transparent	Blue
T42SL	White	Blue

Pinout of interface connector

The following lists the pinout of the interface connector.

Pin	Name	Function
1	OPEN	
2	OPEN	
3	T x D -	Transmission data return output
4	GND	Signal ground
5	R x D -	Receive data return input
6	T x D +	Transmission data output
7	OPEN	
8	R x D +	Receive data input

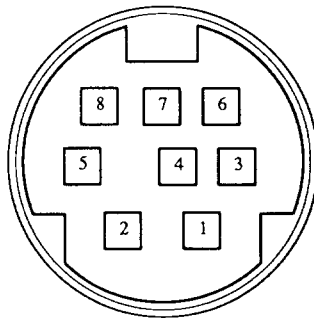

Interface Connector



Index

A	
About	27
About This Macintosh	13
AC adapter	1, 2, 3, 33, 34, 37, 43
AC cord	3
All	25
AppleTalk	16
B	
Banding	24
BBS phone numbers	49
C	
Chooser	16, 20, 37
Cleaning dirt from the printer	34
Cleaning friction rollers	35
Cleaning the platen	35
Cleaning the print head	34
Cleaning the printer	34
Color	18
Color Correction	23
Color QuickDraw	13
Colors	26
ColorSync	23
Connecting the printer	2
Copies	25
Custom...	20, 21
Customer response	50
Customer service information	49
D	
Dark Line Banding	24
Data	18
DIN A4	20
DIN B5	20
Dithering	26
E	
Enlarge	22
Executive	20
F	
Extensions folder	14
Finishing process	31
Flip Horizontal	23
Flip Vertical	23
Font Samples	16
Font styles	41
Fonts	15
From	25
Front cover	11
Front path	10
G	
Getting started	16
Gray scale	27
H	
Head cleaning (See Cleaning)	
Help	27
I	
Ink ribbon cassette	43
Installing the printer driver	14
Installing the TrueType fonts	15
Interface cable	2, 37
Invert Image	23
K	
Key operations	18
Keys	17
L	
Label	18
Lamp explanation	17
Lamps	18
Landscape	22
Layout	22
Legal	20
Letter	20
Line feed	19
Loading paper	8, 9, 10

M		
Media	20	
MultiFinder	13	
N		
Network interface	2	
Not Ready	17	
O		
OHP	18	
OK/Cancel	24	
Optimized Print Quality	24	
Options	22	
Orientation	22	
Other printing functions	28	
P		
Package contents	1	
Page Range	25	
Page Setup	20	
Paper	17, 18	
Paper eject	19	
Paper feed	18	
Paper Feed Adjustment	24	
Paper feeding	39	
Paper jams	11	
Paper release lever	8, 9, 10, 11	
Paper support	5	
Paper tray	8, 10	
Paper tray lever	8	
Paper types	7	
Pinout of interface connector	45	
Placing the printer	1	
Portrait	22	
Power	18	
Power button	2	
Power supply	37, 43	
Print	27	
Print As	26, 27	
Print density	5	
Print speed	41	
Printer driver	13	
Printer supply options	43	
Printing	17, 37	
Printing documents	25	
Printing with color ribbons	28	
Printing with		
iron-on transfer sheets	30	
Printing with		
overhead projection (OHP) film	28	
Printing with strip labels	28	
R		
Ready	17, 18	
Rear path	9	
Reduce	22	
Reference information	41	
Requirements	33	
Resolution	26, 41	
Ribbon	18	
Ribbon cassette	1, 3	
S		
Separations	24	
Setting up	1	
Size	20	
Specifications	41	
Strip Labels	20, 21	
System 7.0	13	
System requirements	13	
System software	13	
T		
Test mode	19	
To	25	
Top of form	9, 18, 19	
Troubleshooting	36	
TrueType fonts	13	
U		
U-shaped paper	5	
U-shaped paper support	1	
Unpacking	1	
W		
White Line Banding	24	

Customer service information

In the event that you are experiencing some technical difficulty with your Star printer, please refer to Chapter 6 - "Maintenance and troubleshooting." This chapter provides you with easy methods to diagnose and resolve problems which you may encounter. For further technical support, you should first contact your Authorized Star Dealer. If you require additional support, Star Micronics offers a wide variety of technical support services. Please use the phone numbers listed below based on the country which your Star printer was purchased.

Star Micronics Technical Hotline:

North America:	1-908-572-3300
Hong Kong:	852-795-2335
Australia:	61-2-748-4300
New Zealand:	64-9-570-1470

Star Micronics FaxBack (Document Retrieval) System:

Requires access to a facsimile machine or board with receive capability

North America:	1-908-572-4004
----------------	----------------

Star Micronics Bulletin Board Service:

Requires a computer modem

North America:	1-908-572-5010
United Kingdom:	44-494-461395
France:	33-1-305807
Germany:	49-69-780929
Netherlands:	31-73-424485
Australia and New Zealand:	61-2-748-2960

Customer response

Star Micronics Co., Ltd. invites your suggestions and comments on your printer and this Users manual. Please address your correspondence to:

Worldwide Headquarters

STAR MICRONICS CO., LTD.
20-10 Nakayoshida
Shizuoka, Japan 422-91
Attn: Product Manager

North and South America Markets

STAR MICRONICS AMERICA, INC.
70-D Ethel Road West
Piscataway, NJ 08854
Attn: Product Manager

European Market

STAR MICRONICS DEUTSCHLAND GMBH
WesterbachstraÙe 59
D-60489 Frankfurt
F.R. of Germany
Attn: Product Manager

U.K. Market

STAR MICRONICS U.K., LTD.
Star House
Peregrine Business Park
Gomm Road, High Wycombe
Bucks. HP13 7DL, U.K.
Attn: Product Manager

French Market

STAR MICRONICS FRANCE S.A.R.L.
25, rue Michaël Faraday
F-78182 St-Quentin en Yvelines Cedex
Attn: Product Manager

Asian Market

STAR MICRONICS ASIA LTD.
18/F Tower 2, Enterprise Square
9 Sheung Yuet Road, Kowloon Bay, HONG KONG
Attn: Product Manager



PRINTED IN JAPAN